

2024 UPS[®] Rate & Service Guide

Daily Rates



Essential Contacts

Support

UPS Customer Service

[ups.com](https://www.ups.com)

1-800-PICK-UPS® (1-800-742-5877)
1-800-877-1548 En Español
1-800-782-7892 International
1-800-811-1648 Billing
1-800-554-9964 Hazardous Materials
1-800-833-0056 Hearing Impaired – TTY/TDD
1-800-833-9943 UPS InfoNotice® Number

customer.service@ups.com

International Shipping

[ups.com/international](https://www.ups.com/international)

1-800-782-7892

Zone Charts

View or download at [ups.com/dailyrateszones](https://www.ups.com/dailyrateszones)

WorldShip® Technical Support

[ups.com/worldshipsupport](https://www.ups.com/worldshipsupport)

1-888-553-1118

UPS Package Design and Test Lab

1-877-877-7229

UPS CampusShip® Support

Help Desk: 1-877-289-6418 (United States)

UPS® Ground Time in Transit

[ups.com/maps](https://www.ups.com/maps)

Freight Services

UPS offers multiple options for shipments over 150 pounds. For more information on these services, go to pages [4-6](#).

Air Freight Services

[ups.com/north-americanairfreight](https://www.ups.com/north-americanairfreight)

[ups.com/internationalairfreight](https://www.ups.com/internationalairfreight)

1-800-443-6379

Ocean Freight Services

[ups.com/oceanfreight](https://www.ups.com/oceanfreight)

1-800-443-6379

UPS Express Critical®

[Express Shipping](#)

1-800-714-8779

UPS Trade Direct®

[Trade Direct](#)

1-800-742-5727

UPS Worldwide Express Freight® Services

[ups.com/freight](https://www.ups.com/freight)

1-800-782-7892

UPS Worldwide Expedited® Ground Freight

[ups.com/freight](https://www.ups.com/freight)

1-800-443-6379

Coyote Logistics® – Truckload and Intermodal

[coyote.com](https://www.coyote.com)

1-877-626-9683

UPS Solutions

Visit [ups.com/services](https://www.ups.com/services) to view the full portfolio of UPS services.

The UPS Store®

[theupsstore.com](https://www.theupsstore.com)

1-800-789-4623

UPS Capital®

[upscapital.com](https://www.ups.com/capital)

1-877-263-8772

Parcel Pro®

[parcelpro.com](https://www.parcelpro.com)

1-888-683-2300

Coyote® Collaborative Transportation Management

[coyote.com](https://www.coyote.com)

1-877-626-9683

UPS Mail Innovations®

[ups.com/mailinnovations](https://www.ups.com/mailinnovations)

1-800-500-2224

UPS Supply Chain Solutions®

[ups.com/supplychainsolutions](https://www.ups.com/supplychainsolutions)

1-800-742-5727

Stay on top of the latest UPS news, announcements and critical updates via email at [ups.com/subscribe](https://www.ups.com/subscribe).

How to Use This Guide

Find what you need to ship your packages – from services and rates to packaging and payment – in the following pages. For your convenience, the “UPS® Rate and Service Guide” is divided into four sections that cover each of the primary steps involved in preparing and processing a shipment. At the beginning of each section, further detail as to what is covered in that section is provided. Essential information regarding the general terms and conditions of service governing UPS and its affiliates in the transportation of packages and UPS Worldwide Express Freight® Midday and UPS Worldwide Express Freight® pallets in the United States is provided in the “UPS Tariff/Terms and Conditions of Service – United States” available at [ups.com/termsandservice](https://www.ups.com/termsandservice).

Section 1

CHOOSING A SERVICE

PAGES [3-9](#)

Determine the service that best meets your needs for domestic, export and import shipping. Also, learn about certain service restrictions that may apply.

Section 2

PREPARING A SHIPMENT

PAGES [10-26](#)

Information about how you package a shipment, determine the rate and get the shipment to UPS is provided.

Section 3

DETERMINING THE RATE

PAGES [27-143](#)

Determine the rates and zones for domestic, export and import shipments. Also, learn about available value-added services.

Section 4

TRACKING AND PAYMENT

PAGES [144-149](#)

Convenient and up-to-the-minute ways to track shipments are reviewed, as well as an explanation of the UPS invoice, its presentation and various billing and payment options.

Table of Contents

In this “UPS® Rate and Service Guide,” you will find the combined 2024 UPS Package Daily and Standard List Rates for the 48 contiguous states, referred to as “Daily Rates,” effective December 26, 2023 (unless otherwise noted). Daily Rates apply to UPS account holders who received Daily Rates prior to July 11, 2016, to shippers who establish a six-digit UPS account on or after July 11, 2016, or as UPS may otherwise agree in writing. You also will find service and rate information for Air Freight. The most current version of this Guide can be downloaded at [ups.com/dailyratezones](https://www.ups.com/dailyratezones).

Choosing a Service

UPS® Services	4
Service Restrictions	7

Preparing a Shipment

Special Packaging Needs	11
Packaging Guidelines	14
Determine the Weight and Size	18
Shipping Solutions	23
Pickup and Drop-off Availability	25

Determining the Rate

Determine the Rate	28
Determine the Rate and Zone	29
West and East State Classifications.....	30
Export	31
Worldwide Zone Chart.....	31
Canada Zone Chart.....	35
UPS® Standard Zone Chart (to Mexico).....	40
Import	41
Worldwide Zone Chart.....	41
UPS 3 Day Select® and	
UPS® Standard Zone Chart (from Canada).....	44
UPS® Standard Zone Chart (from Mexico).....	45
Domestic	46
UPS Next Day Air® Early.....	46
UPS Next Day Air®.....	50
UPS Next Day Air Saver®.....	54
UPS 2nd Day Air A.M.®.....	58
UPS 2nd Day Air®.....	62
UPS 3 Day Select®.....	66
UPS® Ground.....	70
UPS® Simple Rate.....	74
UPS Next Day Air® Freight.....	76
UPS 2nd Day Air® Freight.....	76
UPS 3 Day Freight®.....	76
UPS Next Day Air® Freight NGS.....	77
UPS 2nd Day Air® Freight NGS.....	77
UPS 3 Day Freight® NGS.....	77
Export	78
Shipment Pricing.....	78
UPS Worldwide Express Plus®.....	79
UPS Worldwide Express®.....	79
UPS Worldwide Express Freight® Midday.....	82
UPS Worldwide Express Freight®.....	83

Determining the Rate *(continued)*

Export <i>(continued)</i>	
UPS Worldwide Saver®.....	84
UPS Worldwide Expedited®.....	87
UPS® Standard	
To Canada.....	90
To Mexico.....	93
Import	96
Shipment Pricing.....	96
UPS Worldwide Express Plus.....	97
UPS Worldwide Express NA1®.....	97
UPS Worldwide Express.....	97
UPS Worldwide Express Freight Midday.....	100
UPS Worldwide Express Freight.....	101
UPS Worldwide Saver.....	102
UPS Worldwide Expedited.....	105
UPS 3 Day Select® from Canada.....	108
UPS Standard	
From Canada.....	109
From Mexico.....	111
Value-Added Services	114
Package.....	116
UPS Returns®.....	120
Other Services – General.....	121
International.....	122
Recipient Services.....	124
North American Freight.....	131
North American Air Freight.....	133
UPS Worldwide Expedited® Ground Freight.....	136
Other Charges	115
Package.....	127
North American Freight.....	132
North American Air Freight.....	134
UPS Worldwide Expedited Ground Freight.....	137
Customs Brokerage	139
Tracking and Payment	
Track Your Shipment	145
Reviewing Your Invoice	147
Appendix	
Appendix	150
Index	
Index	153

How to Use This Guide

Section 1

CHOOSING A SERVICE

Determine the service that best meets your needs for domestic, export and import shipping. Also, learn about certain service restrictions that may apply.

- Overview of UPS® services. Pages [4-6](#)
 - Review service restrictions for domestic, export and import shipments. Pages [7-9](#)
-

Section 2

PREPARING A SHIPMENT

PAGES [10-26](#)

Section 3

DETERMINING THE RATE

PAGES [27-143](#)

Section 4

TRACKING AND PAYMENT

PAGES [144-149](#)

UPS® Services

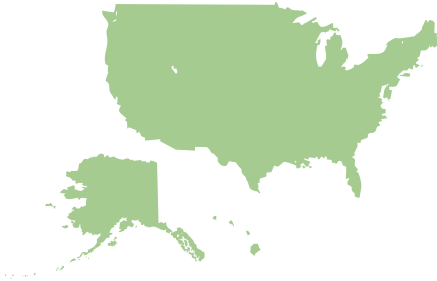

United States – Package

	Same Day	1 Day	2 Days	3 Days	Within 5 Days	Page
UPS Express Critical®	●					*
UPS Next Day Air® Early		●				46
UPS Next Day Air®		●				50
UPS Next Day Air Saver®		●				54
UPS 2nd Day Air A.M.®			●			58
UPS 2nd Day Air®			●			62
UPS 3 Day Select®				●		66
UPS® Ground					●	70
UPS® Simple Rate		●	●	●	●	74

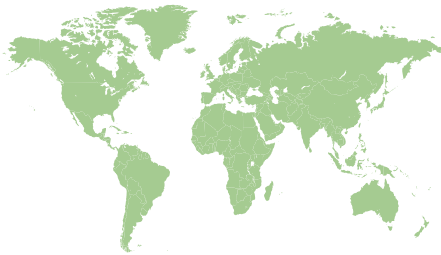

International – Package and Freight

	Best Available Flight	1-3 Days	2-5 Days	Within 3 Days	3-5 Days	Day-Definite	Export Page	Import Page
UPS Express Critical	●						*	*
UPS Worldwide Express Plus®		●					79	97
UPS Worldwide Express NA1®		●					N/A	97
UPS Worldwide Express®		●					79	97
UPS Worldwide Express Freight® Midday		●					82	100
UPS Worldwide Express Freight®		●					83	101
UPS Worldwide Saver®		●					84	102
UPS Worldwide Expedited®			●				87	105
UPS 3 Day Select® from Canada				●			N/A	108
UPS® Standard to/from Canada						●	90	109
UPS® Standard to/from Mexico						●	93	111
UPS® Air Freight Premium Direct		●					**	**
UPS Air Freight Direct®		●					**	**
UPS Air Freight Consolidated®					●		**	**

*Visit upsexpresscritical.com or call 1-800-714-8779 for rates and information.

**Call 1-800-443-6379 for rates and additional information.

Notes:

- Some shipments to and from certain locations may require additional time in transit. For guarantee details, service availability and time commitments, visit ups.com for packages and ups.com/supplychainsolutions (or call 1-800-443-6379) for Air Freight.
- Visit ups.com/holidays for time-in-transit changes effective during the holiday season.

UPS® Services

North American Freight (Air and Ground)

	Same Day	1 Day	2 Days	2-3 Days	3-5 Days	Within 3-4 Days	Day-Definite	Page
UPS Express Critical®	●							*
UPS Next Day Air® Freight		●						76
UPS Next Day Air® Freight NGS		●						77
UPS 2nd Day Air® Freight			●					76
UPS 2nd Day Air® Freight NGS			●					77
UPS Worldwide Expedited® Air Freight (U.S.-Mexico)				●				**
UPS Worldwide Expedited® Ground Freight (U.S.-Mexico)					●			**
UPS Worldwide Expedited® Truckload (U.S.-Mexico)					●			**
UPS 3 Day Freight®						●		76
UPS 3 Day Freight® NGS						●		77
Coyote Logistics® Truckload and Intermodal							●	6
Coyote® Collaborative Transportation Management							●	6

*Visit upsexpresscritical.com or call 1-800-714-8779 for rates and information.

**Delivery is guaranteed when UPS is the customs broker. Call 1-800-443-6379 for rates and additional information.



Ocean Freight

Full-Container Load (FCL) NVOCC Service	Multiple sailings weekly <ul style="list-style-type: none"> • Dedicated service in all major global ports and markets • Door-to-door service available; customs clearance optional
Less-Than-Container Load (LCL) NVOCC Service	Weekly fixed-day sailings <ul style="list-style-type: none"> • Service in all major global ports and markets • Customs clearance optional
UPS Preferred® Multimodal Freight Services***	Better balance of speed and cost via: <ul style="list-style-type: none"> • UPS Preferred LCL to North America • UPS Preferred FCL and LCL between China and Europe • UPS Preferred Sea/Air from Asia
Ocean Freight Forwarding	Carrier booking, document processing, load coordination and container yard management
Project Cargo Management	Specialized multimodal transport for breakbulk with document processing <ul style="list-style-type: none"> • Service in all major global ports and markets • Customized single-project solutions • Charter vehicles/vessels available

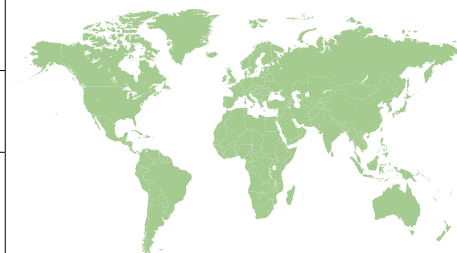

***UPS Preferred Multimodal Freight Services subject to applicable tariff rules.

Notes:

- Some shipments to and from certain locations may require additional time in transit. For guarantee details, service availability and time commitments, visit ups.com for packages and ups.com/supplychainsolutions (or call 1-800-443-6379) for Air Freight and UPS Worldwide Expedited Ground Freight.
- Visit ups.com/holidays for time-in-transit changes effective during the holiday season.
- Ocean Freight services are provided pursuant to the “UPS Supply Chain Solutions® (Ocean Freight Forwarding) Terms and Conditions” and the “Non-Vessel Operating Common Carrier (NVOCC) Terms and Conditions,” each available at UPS Supply Chain Solutions ups.com/freighttermsofservice. Services listed above are available in most major markets. Please refer to the Terms and Conditions for more details.

UPS® Services

Service	Description
UPS CAPITAL® SERVICES	
InsureShield® Shipping Insurance through UPS Capital Insurance Agency, Inc.	<p>Protect in-transit shipments and warehoused goods against loss, damage and porch piracy with higher coverage limits than non-insurance declared value programs. Insurance services available within the U.S. and select European, Canadian and Asian markets.</p> <ul style="list-style-type: none"> – Worldwide coverage for package and freight shipments regardless of mode and carrier. – Coverage options for unique commodities, including wine/spirits and other time- and temperature-sensitive goods. – Call 1-877-263-8772 or visit insureshield.com to request a quote or for more information.
Parcel Pro® Select	<ul style="list-style-type: none"> – Coverage and advanced risk mitigation protocols for jewelry, loose stones, watches and collectibles through Parcel Pro® Service. – Call 888-683-2300 or visit parcelpro.com for more information.
Payments	<p>Accept payments securely and easily with UPS Capital® Merchant Services.</p> <ul style="list-style-type: none"> – Multiple payment options. – Call 1-877-263-8772 or visit upscapital.com. – Next-business-day funding.
COYOTE LOGISTICS®	
Truckload and Intermodal	<ul style="list-style-type: none"> – Coyote Logistics, a UPS company, provides truckload and intermodal brokerage and transportation management services across a wide range of industries. – Services include asset utilization, dry van, temperature-controlled and open-deck, using a network of more than 50,000 carriers. Areas of service include North America and Europe. – Our intermodal solution is a cost-efficient option for long-haul moves and will help you reduce your carbon footprint. You'll benefit from transparent technology, including real-time visibility, tracking updates and access to load details on all of your shipments. – Call 1-877-626-9683 or visit coyote.com to request a quote or for more information.
Collaborative Transportation Management	<ul style="list-style-type: none"> – Coyote's Collaborative Transportation Management program offers comprehensive solutions for supply chain planning and optimization, transportation management, and strategic sourcing of capacity. – Shippers can leverage advanced analytics and custom reporting on a web-based Collaborative Transportation Management portal, driven by Coyote's constantly evolving proprietary technology. – Send an email to managedsolutions@coyote.com for more information.
MULTIPLE-PACKAGE SHIPMENTS	
These offerings are ideal for multiple-package shipments where a pallet is not required. Each package has its own shipping label and unique tracking number.	
UPS® Ground with Freight Pricing	<ul style="list-style-type: none"> – Contractual service for UPS Ground delivery within one to five business days in the 48 contiguous states for shipments over 150 pounds. – With UPS Ground with Freight Pricing, customers have the ability to rate and ship UPS Ground service using Less-Than-Truckload (LTL) shipment characteristics, such as Freight Class. Visit ups.com/gfp for more information.
UPS Hundredweight Service®	<ul style="list-style-type: none"> – Contractual service for shipments with two or more packages going to the same destination on the same business day and having a minimum shipment weight of 100 pounds for Air Services and 200 pounds for UPS Ground. – Available with UPS Next Day Air®, UPS Next Day Air Saver®, UPS 2nd Day Air A.M.®, UPS 2nd Day Air®, UPS 3 Day Select® and UPS Ground shipments. – Delivery within one to five business days in all 50 states and Puerto Rico.

Notes:

– Visit ups.com/holidays for time in transit changes effective during the holiday season.

– UPS Capital Insurance Agency, Inc.

Insurance coverage is underwritten by an authorized insurance company and issued through licensed insurance producers, including UPS Capital Insurance Agency, Inc. ("UPSCIA"), a subsidiary of UPS Capital Corporation. The insurance company, UPSCIA and its licensed affiliates reserve the right to change or cancel the program at any time. This information does not in any way alter or amend the terms, limitations or exclusions of the applicable insurance policy or program. Insurance coverage is not available in all jurisdictions.

– Parcel Pro

Insurance coverage is provided under a policy issued by an authorized insurance company to Parcel Pro, Inc. Terms, restrictions and conditions apply. Please speak to a sales representative for more details.

– UPS Capital Merchant Services

Businesses are required to complete an application and agree to terms and conditions at the time of enrollment. All businesses are subject to credit approval. Merchant services are provided by Paymentech, LLC ("Chase"), a subsidiary of JPMorgan Chase Bank, N.A. See Additional Product Disclosures and Terms and Conditions for more details.

Domestic, Export and Import Service Restrictions

PACKAGE

Hazardous Materials and International Dangerous Goods

UPS will accept domestic Air Dangerous Goods shipments prepared under Department of Transportation (D.O.T.) Title 49 of the Code of Federal Regulations (49 CFR) or the International Air Transport Association (IATA) regulation sets. The domestic Hazardous Materials and International Dangerous Goods (IDG) functionality is integrated into the current version of WorldShip® software. Contact the Hazardous Materials Support Center at 1-800-554-9964 for more information.

Select Hazardous Materials, as defined and regulated under 49 CFR, and Dangerous Goods, as defined under the International Civil Aviation Organization (ICAO) and published in the IATA “Dangerous Goods Regulations,” are accepted for transportation only as a contractual service domestically within and between all 50 states and Puerto Rico, and internationally within or between defined service areas. Effective April 3, 2017, a separate contract is required to ship Cargo Aircraft Only (CAO) quantities for classes 1-8 (contact the Hazardous Materials Support Center at 1-800-554-9964 for more information).

Setting Up Service for Hazardous Materials and Dangerous Goods

To receive Hazardous Materials or Dangerous Goods service, including UPS® Standard to Canada, the shipper must have a Scheduled Pickup account and agree to the provisions set forth in the online “UPS Dangerous Goods Agreement Checklist” or an approved prior domestic or international agreement or have these same provisions incorporated into their existing customized contract.

Location Restrictions for Ground and Air Services

UPS does not accept hazardous materials, including Consumer Commodities, Limited Quantities (Ltd Qty) and combustibles, via UPS® Ground service to and from Alaska; Hawaii; Puerto Rico; Avalon, CA; Catalina Island, CA; Beaver Island, MI; Mackinac Island, MI (winter only); the Bass Islands, OH; Kelleys Island, OH; and San Juan Islands, WA. Many products that are not regulated or do not require shipping papers via UPS Ground

are fully regulated when transported via aircraft. Hazardous Materials are accepted for transportation via UPS Air Services to and from Alaska, Hawaii, Puerto Rico and Catalina Island only in passenger aircraft quantities without an additional contract granting access to Cargo Aircraft Only (CAO) quantities for classes 1-8 (contact the Hazardous Materials Support Center at 1-800-554-9964 for more information). Shipments must be prepared according to the requirements set forth in either Title 49 of the Code of Federal Regulations (49 CFR) or in the IATA regulations and the “UPS Guide for Shipping Ground and Air Hazardous Materials” at ups.com/hazmat.

UPS 3 Day Select®

When preparing Hazardous Materials packages for UPS 3 Day Select shipping, packages must be prepared in accordance with the applicable air regulations. Many products that are not regulated or do not require shipping papers via UPS Ground are fully regulated when transported via aircraft. Hazardous Materials are accepted for transportation in UPS 3 Day Select shipments only in passenger aircraft quantities without an additional contract granting access to Cargo Aircraft Only (CAO) quantities for classes 1-8 (contact the Hazardous Materials Support Center at 1-800-554-9964 for more information). Shipments must be prepared according to the requirements set forth in either Title 49 of the Code of Federal Regulations (49 CFR) or in the IATA regulations and the “UPS Guide for Shipping Ground and Air Hazardous Materials,” available at ups.com/hazmat.

Limited Quantities (Ltd Qty)

Ltd Qty shipments are accepted for transportation without Hazardous Materials shipping papers and without a contract, only within the 48 contiguous states via UPS Ground, UPS Ground with Freight Pricing and UPS Hundredweight Service® shipping for UPS Ground shipments, and via UPS Standard to Canada and UPS Ground Intra-Alaska and Intra-Oahu services, when properly classified, packaged and marked, provided the

shipper has reviewed the service restrictions with a UPS representative.

UPS Ground, UPS Ground with Freight Pricing and UPS Hundredweight Service shipping for UPS Ground shipments are not available for Ltd Qty shipments to and from Avalon, CA; Catalina Island, CA; Beaver Island, MI; Mackinac Island, MI (winter only); the Bass Islands, OH; Kelleys Island, OH; and San Juan Islands, WA.

Ltd Qty packages shipped via UPS Domestic Air Services and UPS 3 Day Select shipping within the U.S. and Puerto Rico, and Consumer Commodity and Ltd Qty shipments to IDG destinations, are accepted for transportation on a contractual basis only.

UPS Express Critical®

UPS Express Critical service accepts Hazardous Materials and International Dangerous Goods shipments via ground transportation or air charter service only (certain restrictions apply).

Dry Ice

UPS accepts most non-Dangerous Goods shipments containing dry ice within the U.S. without requiring the shipper to enter into the UPS Dangerous Goods Agreement. Refer to page 129 for more information. International dry ice shipping is available on a contractual basis only.

International Dangerous Goods (IDG)

UPS accepts IDG on a contractual basis only. The “UPS Guide for Shipping International Dangerous Goods” should always be used in conjunction with the most current IATA “Dangerous Goods Regulations.” UPS only transports Dangerous Goods to and from IDG countries and territories. When preparing Dangerous Goods packages for any UPS Worldwide Express®, UPS Worldwide Expedited® or UPS Worldwide Saver® Service, packages must be prepared in accordance with the applicable air regulations. The Dangerous Goods Service handling charge applies to all packages and palletized shipments that require a “Shipper’s Declaration for Dangerous Goods.” Refer to page 128 for fees.

Notes:

- UPS Worldwide Express Freight® Middy and UPS Worldwide Express Freight® services are included unless otherwise noted.
- Hazardous Materials are not accepted for transportation using UPS® Simple Rate, UPS Ground with Freight Pricing or UPS Worldwide Expedited Ground Freight.
- For shipping Dangerous Goods and Hazardous Materials via Air Freight, refer to the “UPS Air Freight Terms and Conditions of Contract for UPS Air Freight Services in the United States, Canada and International” at UPS Supply Chain Solutions ups.com/freighttermsofservice or call 1-800-443-6379 for more information.
- For additional service restrictions, refer to the “UPS Tariff/Terms and Conditions of Service – United States” available at ups.com/termssofservice.

Domestic, Export and Import Service Restrictions

PACKAGE

Prohibited and Restricted Goods

Alcoholic Beverages

Packages containing alcoholic beverages (beer, wine or spirits) are accepted for transportation only on a contractual basis. Shippers must be licensed and authorized under applicable law to ship alcoholic beverages. Alcoholic beverages are accepted for transportation only to certain states. To receive service for packages containing alcoholic beverages, the shipper must enter into, and agree to, the provisions set forth in the approved UPS agreement for the transportation of alcoholic beverages shipments. For the convenience of recipients, shippers can send packages containing alcoholic beverages directly to a UPS Access Point® Location.* Shipments containing alcoholic beverages also can be delivered to an alternate address via UPS Delivery Intercept® service or redirected to a UPS Access Point Location via UPS My Choice®.

C.O.D.

Collect on Delivery (C.O.D.) service is not available for UPS Express Critical® or international services. C.O.D. service is not available for UPS Worldwide Express Freight Middy and UPS Worldwide Express Freight services. C.O.D. service is also not available when using a UPS 3 Day Select® or a UPS® Ground shipping document.

Firearms, Ammunition and Weapons

Firearms, ammunition and weapons (including inert and replica explosive weapons) will be accepted for transportation only according to the “UPS Tariff/Terms and Conditions of Service – United States” available at [ups.com/termsofservice](https://www.ups.com/termsofservice).

Jewelry, Unset Precious Stones and Industrial Diamonds

International jewelry shipments, and shipments of unset precious stones or industrial diamonds, are subject to maximum declared value restrictions that vary by destination as set forth at [ups.com/jewelry](https://www.ups.com/jewelry).

Maximum Length

The maximum length per domestic, export or import package is 108 inches. There are no maximum length restrictions for UPS Express Critical packages.

Maximum Size

The maximum size per domestic, export or import package is 165 inches in length plus girth [(2 x width) + (2 x height)] combined. The maximum size per UPS® Simple Rate package is 1,728 cubic inches. For irregularly shaped packages, refer to page 19 for instructions. UPS Worldwide Express Freight Middy and UPS Worldwide Express Freight pallets are subject to maximum size restrictions (which vary by origin and destination) as set forth at [ups.com/wwefmaxdimweight](https://www.ups.com/wwefmaxdimweight). Prior approval is required to ship UPS Worldwide Express Freight Middy and UPS Worldwide Express Freight shipments exceeding maximum size and weight restrictions. There are no maximum size restrictions for UPS Express Critical packages.

Maximum Declared Values

Shippers are prohibited from shipping, and UPS does not accept for transportation, packages having a value of more than \$50,000.00, except for a package eligible for the Enhanced Maximum Declared Value of \$70,000.00 per package, as set forth in the “UPS Tariff/Terms and Conditions of Service – United States” available at [ups.com/termsofservice](https://www.ups.com/termsofservice). A package is eligible only if it is a domestic UPS Next Day Air® delivery service shipment, is tendered pursuant to shipper's scheduled pickup service, is processed for shipment using a UPS Shipping System (declarations of value on paper source documents are not eligible) and does not contain hazardous materials or a perishable commodity. For UPS Worldwide Express Freight Middy and UPS Worldwide Express Freight services, UPS does not accept for transportation pallets having a value of more than \$100,000.00 per pallet.

Additionally, more restrictive value limits apply for certain packages and pallets.

Refer to the “UPS Tariff/Terms and Conditions of Service – United States” available at [ups.com/termsofservice](https://www.ups.com/termsofservice) for more information on maximum allowable values and liability limitations.

Maximum Weight

For domestic package shipments, the maximum actual weight per package is 150 pounds. The maximum actual weight per UPS Simple Rate package is 50 pounds.

For international shipments, the maximum weight of a package may vary by destination or origin. UPS Worldwide Express Freight Middy and UPS Worldwide Express Freight pallets are subject to maximum weight restrictions (which vary by origin and destination) as set forth at [ups.com/wwefmaxdimweight](https://www.ups.com/wwefmaxdimweight). Prior approval is required to ship UPS Worldwide Express Freight Middy and UPS Worldwide Express Freight shipments exceeding maximum size or weight restrictions. There are no maximum weight restrictions for UPS Express Critical packages. Call the UPS International Customer Service Center at 1-800-782-7892 for more information.

Maximum Weight for a Hazardous Materials and International Dangerous Goods Package

The maximum weight for a Domestic Hazardous Materials/Dangerous Goods maximum gross weight is 70 pounds for domestic U.S. shipments and 30 kilograms for International Dangerous Goods, unless further restricted by the regulations set forth in 49 CFR or IATA regulations. Maximum weight for a non-Hazardous Materials package shipment containing dry ice is 150 pounds. Consult the “UPS Guide for Shipping Ground and Air Hazardous Materials” at [ups.com/hazmat](https://www.ups.com/hazmat) or call the Hazardous Materials Support Center at 1-800-554-9964 for more information.

Notes:

- UPS Worldwide Express Freight® Middy and UPS Worldwide Express Freight® services are included unless otherwise noted.
- For Air Freight or UPS Worldwide Expedited® Ground Freight service restrictions, refer to UPS Supply Chain Solutions at [ups.com/supplychainsolutions](https://www.ups.com/supplychainsolutions).
- For additional service restrictions, refer to the “UPS Tariff/Terms and Conditions of Service – United States” available at [ups.com/termsofservice](https://www.ups.com/termsofservice).

*For information about Ship to a UPS Access Point® Location, refer to page 117.

Domestic, Export and Import Service Restrictions

PACKAGE

Prohibited and Restricted Goods (continued)

Restricted and Prohibited Articles (Export and Import)

It is the shipper's responsibility to comply with current government regulations or laws applicable in each country.

Shipments are subject to inspection and possible delay by customs officials or representatives of other government agencies. Certain countries and territories have additional prohibited or restricted articles. For more information, call the UPS International Customer Service Center at 1-800-782-7892.

The following items are restricted for international shipping. They may be shipped into the U.S., and to countries and territories outside the U.S., only where service is allowed on a contractual basis:

- Alcoholic beverages
- Animal products, non-domesticated (e.g., mother of pearl inlay, snakeskin watch bands)
- Articles of high/unusual value
- Biological substances, Category B and exempt human or animal specimens
- Dangerous goods
- Firearms and weapons (including inert and replica explosive weapons)
- Furs
- Gold or other precious metals
- Live animals*
- Perishables
- Personal effects**
- Plants
- Seeds
- Tobacco and Vaping Products

The following items are not accepted for transportation by UPS into the U.S. or to countries and territories outside the U.S.:

- Ammunition (except as expressly provided in the "UPS Tariff/Terms and Conditions of Service – United States" available at [ups.com/termservice](https://www.ups.com/termservice))
- Coins, cash, currency, bonds, postage stamps, money orders and negotiable instruments (such as drafts, bills of exchange or promissory notes, but excluding checks)
- Corpses, cremated or disinterred remains

- Fireworks
- Hazardous waste
- Ivory
- Marijuana, including marijuana intended for medicinal use
- Shark fins
- Shipments prohibited by law

Tobacco and Vaping Products

Shipments containing tobacco products ("Tobacco Product Shipments") are accepted for transportation only from shippers who are licensed and authorized to ship tobacco products pursuant to applicable laws. UPS does not provide service to any person or entity listed in the Bureau of Alcohol, Tobacco, Firearms and Explosives PACT Act – Non-Compliant List.

The term "Tobacco Products" is defined at [ups.com/tobacco](https://www.ups.com/tobacco). Shippers should consult [ups.com/tobacco](https://www.ups.com/tobacco) for the current definition of tobacco products, as the definition may change periodically. At present, and without limiting the complete definition posted at [ups.com/tobacco](https://www.ups.com/tobacco), the term "Tobacco Products" includes any product made or derived from tobacco that is intended for human consumption, including any component, part or accessory of a tobacco product; the term includes, without limitation, e-cigarettes, e-hookah, e-cigars, vape pens, advanced refillable personal vaporizers and electronic pipes.

UPS prohibits the shipment of Cigarettes or Little Cigars (as those terms are defined at [ups.com/tobacco](https://www.ups.com/tobacco)) to consumers. UPS also prohibits the shipment of all Vaping Products (as the term is defined at [ups.com/tobacco](https://www.ups.com/tobacco)) throughout its U.S. domestic network, including import and export, regardless of nicotine content and destination state. To make other Tobacco Product Shipments, the shipper must sign, agree to and comply with the provisions set forth in an approved UPS agreement for the transportation of Tobacco Products.

Shippers and receivers must comply with all applicable federal, state, provincial or local laws or regulations, and all Tobacco Product Shipments must conform to the terms, conditions, restrictions and prohibitions set forth at [ups.com/tobacco](https://www.ups.com/tobacco) at the time of shipping. It is the responsibility of the shipper to ensure that a shipment tendered to UPS, including a Tobacco Product Shipment, does not violate any federal, state, provincial or local laws or regulations applicable to the shipment.

All shipments, including shipments containing Tobacco Products, will be accepted for transportation only according to the "UPS Tariff/Terms and Conditions of Service – United States" available at [ups.com/termservice](https://www.ups.com/termservice).

Tobacco Products may not be shipped from a UPS® Drop Box, UPS Customer Center, UPS Alliance Location (Staples), locations of The UPS Store®, any UPS Authorized Shipping Outlet or UPS Access Point® Location. Please visit [ups.com/tobacco](https://www.ups.com/tobacco) for more information.

UPS Returns®

UPS Returns Services are not provided via UPS Next Day Air Saver® or UPS 2nd Day Air A.M.® service levels. UPS Returns Service options for UPS® Simple Rate are limited to UPS Print Return Label Service only. Hazardous Materials or Dangerous Goods packages, pallets requiring shipping papers and packages containing firearms cannot be retrieved via UPS Returns Services. Biological substances and dry ice can be retrieved via UPS Returns Services. No other restricted or prohibited articles may be retrieved with UPS Returns Services. Refer to [ups.com/termservice](https://www.ups.com/termservice) for value limits on UPS Returns Services shipments. Multiple-piece shipments are not available for UPS Returns Services shipped within the 50 states and Puerto Rico.

Notes:

- UPS Worldwide Express Freight® Middy and UPS Worldwide Express Freight® services are included unless otherwise noted.
 - For Air Freight or UPS Worldwide Expedited® Ground Freight service restrictions, refer to UPS Supply Chain Solutions at [ups.com/freighttermservice](https://www.ups.com/freighttermservice).
 - For additional service restrictions, refer to the "UPS Tariff/Terms and Conditions of Service – United States" available at [ups.com/termservice](https://www.ups.com/termservice).
- *Select live animals may be shipped only pursuant to the restrictions and conditions set forth at [ups.com/animals](https://www.ups.com/animals).*
- **Limited shipping of personal effects is available at The UPS Store and any UPS Customer Center.*

How to Use This Guide

Section 1 CHOOSING A SERVICE

PAGES [3-9](#)

Section 2

PREPARING A SHIPMENT

Information about how you package a shipment, determine the rate and get the shipment to UPS is provided.

- Review tips for special packaging. Pages [11-13](#)
 - Understand the basics of proper packaging and labeling. Pages [14-17](#)
 - Determine the weight and size. Pages [18-22](#)
 - Select automated or manual processing options, including online shipping solutions, shipping documents and the UPS Waybill. Pages [23-24](#)
 - Arrange for a UPS pickup or drop-off at a variety of locations that accept UPS packages. Pages [25-26](#)
-

Section 3 DETERMINING THE RATE

PAGES [27-143](#)

Section 4 TRACKING AND PAYMENT

PAGES [144-149](#)

Special Packaging Needs

PACKAGE

If you ship the following items, consider their special packaging needs.

Batteries

A variety of batteries are regulated as hazardous materials by the U.S. Department of Transportation (DOT) and International Air Transport Association (IATA). For assistance in determining whether or not your battery shipment is regulated, please call the DOT's Hazardous Materials Info-line at 1-800-467-4922. Batteries requiring shipping papers may only be tendered by contract hazmat shippers. (See the "UPS® Guide for Shipping Ground and Air Hazardous Materials" at [ups.com/hazmat](https://www.ups.com/hazmat).)

Any device with batteries installed must have its on/off switch protected from being activated or have the batteries removed with the terminals protected. Simple devices like flashlights or rechargeable drills can generate a dangerous amount of heat if accidentally activated. Electronic items sent for repair, such as computers and cell phones, should be sent without batteries. For additional information regarding the shipment of batteries and current lithium battery regulations, please refer to [ups.com/batteries](https://www.ups.com/batteries).



Bundled or Strapped Boxes

Only same-sized boxes may be strapped together. Use a minimum of four crisscrossed bands, two in each direction. An address label must be placed on each box. When strapping boxes together, each box must be strong enough to hold the total weight of the strapped bundle.

For example, if two 15-pound boxes are banded together into a 30-pound package, both components should be in boxes with at least a 30-pound weight capacity. An Additional Handling charge may apply. Refer to page [127](#) for more information.



Electronic Media

To ship electronic media that contain sensitive personal information (such as personal, financial or health information), we recommend that you do not use an envelope, letter packaging, UPS Express® Envelope, UPS Express® Envelope – Reusable, UPS Express® Pak or UPS Express® Pad Pak. UPS provides special packaging, the UPS Express® Hard Pak – Secure, which is designed to help you ship sensitive electronic media. Call 1-800-PICK-UPS® (1-800-742-5877) or your sales representative for more information.

You can also ship electronic media containing sensitive personal information by packaging it with a duplicate shipping label in an inner container that can be securely sealed. Place the inner container in a new outer corrugated box. Seal all flaps securely. Prior to packaging, mark the electronic media with identifiable information, such as your company name, reference number or your UPS shipping number. Additionally, the shipper should retain a copy of the data and secure the data on the electronic media through encryption or other technological means.



Special Packaging Needs

PACKAGE

Fabric and Wallpaper

Rolled goods travel best when shipped in corrugated boxes. If a fabric or wallpaper roll is shipped in a bag, UPS recommends a bag with a minimum thickness of six mils. Make sure the bag is tightly wrapped and taped against the roll to reduce the risk of tearing. A tail on an item shipped in a bag must be compressed to the body of the item using tape.

Place the address label on a flat surface of the item being shipped. Place duplicate address labels inside cores or between top layers of material. An Additional Handling charge may apply. Refer to page [127](#) for more information.



Irregularly Shaped Items and Bare Metals

Tape the address label on a flat surface of the item being shipped. Cover the label with clear tape. Do not use "flying tags" attached by string or metal. Blunt all sharp or protruding edges with taped-on, corrugated cardboard pieces. Protect the surface of the item as needed. An Additional Handling charge will apply. Refer to page [127](#) for more information.

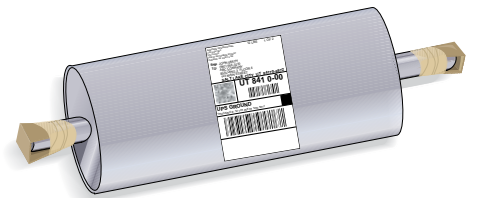

Large and/or Heavy Packages

Packaging materials need to be evaluated carefully for packages weighing more than 70 pounds.

A UPS Heavy Package sticker is required whenever you ship packages weighing more than 70 pounds. Place the sticker to the right of the address label and write the package's weight in the white box. It also helps to highlight every side of your package with Heavy Package highlight tape. This sends a warning to those who risk lifting your package, both your employees and ours.

Customers with a UPS account can request supplies, free of charge. Order [Supplies and Forms](#) by visiting [ups.com](#). Refer to the Large Package Surcharge on page [129](#) for fees.



Tires

Apply a wide band of pressure-sensitive tape through the center and completely around the body of the tire so that the tape is attached to itself. Attach your address label to the tape band where it covers the tread. Cover the entire label with clear tape. An Additional Handling charge will apply. Refer to page [127](#) for more information.



If you have highly sensitive or confidential material, UPS Express Critical® shipping offers a same-day service to handle your specialized needs. To get more information, please call 1-800-714-8779 or speak with your sales representative.

Special Packaging Needs

PACKAGE

Packaging Assistance

Packaging Advisor

The Packaging Advisor is an online tool that takes the guesswork out of packing and helps you determine just what you need by walking you through industry guidelines. Depending on your entries, the Packaging Advisor will provide guidelines about exterior carton, interior cushioning, product placement, closure and shipping label placement. Visit [ups.com/packaging](https://www.ups.com/packaging).

UPS Package Design and Test Lab

The UPS Package Design and Test Lab helps customers find effective, sustainable and cost-efficient packaging for products. Packaging engineers evaluate the current or proposed package, conduct a variety of industry-accepted tests and prepare a written report that recommends modifications to improve performance, economy and efficient use of materials. The UPS Package Design and Test Lab also monitors the latest developments in package-testing research worldwide. Additionally, the UPS Package Design and Test Lab can assist in finding environmentally friendly packaging solutions that provide adequate product protection. Contact the UPS Package Design and Test Lab at 1-877-877-7229 for more details and pricing information.

Packing Services

Have your items organized and expertly packed at your nearest location of The UPS Store®. Many locations of The UPS Store also offer custom handling and packaging for large items – from blanket wrap to custom cartons and crating. Regardless of the size and shape of your items, locations of The UPS Store can handle your shipping needs. With the Pack & Ship Guarantee, participating locations will pack and ship your item via UPS, and if that item is damaged or lost in transit, you'll be reimbursed. Visit theupsstore.com/guarantee for details. For more information on all services available at The UPS Store or to find a location near you, please visit theupsstore.com.

Packaging Guidelines

PACKAGE

Proper Packaging

To ensure that proper packaging is used and that contents are adequately and securely packed, wrapped and cushioned for transportation, shippers should:

- Use a new or almost new rigid box with flaps intact
- Wrap all items separately
- Use adequate cushioning material
- Use strong tape designed for shipping
- Never use string or paper overwrap

Additional guidance on proper packaging is available at [ups.com](https://www.ups.com) under Packaging Guidelines.

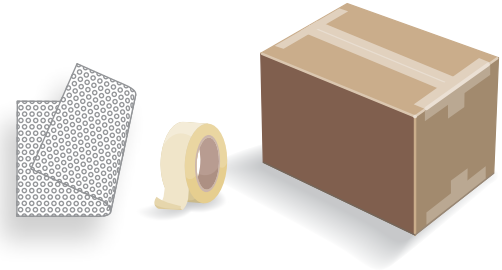

Proper Labeling

Each package must also be properly labeled with an approved UPS label containing a valid UPS tracking number. Shippers should:

- Securely affix to each package a UPS-issued paper shipping document or label generated through an approved UPS automated shipping system that contains clear, complete delivery and return information, including, among other things, the UPS tracking number, shipper name and address, and consignee name and address
- Place a duplicate address label inside the package
- Remove or conceal any labels, hazardous materials indicators and other previous shipment markings on the box that are no longer applicable



Packaging Guidelines

UPS WORLDWIDE EXPRESS FREIGHT® MIDDAY, UPS WORLDWIDE EXPRESS FREIGHT®, UPS WORLDWIDE EXPEDITED® GROUND FREIGHT AND AIR FREIGHT

Preparing Your Freight Shipment

UPS Worldwide Express Freight Midday and UPS Worldwide Express Freight (“UPS Worldwide Express Freight Services”)

UPS Worldwide Express Freight Services are for palletized shipments. Pre-authorization is required for all pallets exceeding maximum size or weight restrictions (which vary by origin and destination) as set forth at [ups.com/assets/resources/media/wwef_max_dim.pdf](https://www.ups.com/assets/resources/media/wwef_max_dim.pdf). For UPS Worldwide Express Freight Services, scheduling a pickup or drop-off is required on all shipments through WorldShip®, ups.com shipping and UPS CampusShip® systems, a UPS Ready® solution, UPS® Developer Kit, [ups.com](https://www.ups.com) or by calling 1-800-782-7892.

Air Freight and UPS Worldwide Expedited Ground Freight

Air Freight and UPS Worldwide Expedited Ground Freight shipments can include combinations of palletized items or boxes that are too large to ship using other UPS services. They can also include multiple non-palletized pieces. UPS will accept freight shipments of any weight; however, minimum weight charges may apply. Pre-authorization is required for Air Freight and UPS Worldwide Expedited Ground Freight shipments that exceed 120 inches in length, 84 inches in width, 76 inches in height or 5,000 pounds in weight.

Palletized Freight

Palletizing freight helps multiple-piece shipments remain together and provides increased protection from damage. Each pallet, including its contents, is considered one piece.

Non-Palletized Freight

Loose items, such as boxes or containers that have not been secured to a pallet, are considered non-palletized freight. Each loose item is considered one piece and can be shipped via Air Freight or UPS Worldwide Expedited Ground Freight services.

Palletizing Your Shipment

Pallets are portable rigid platforms used to consolidate shipments and allow for ease of freight movement. Quality pallets are commonly made of either wood or plastic and can weigh between 20 and 70 pounds. Pallets should be large enough to accommodate the shipment without

overhang. Anything overhanging the pallet edges may be damaged from punctures, abrasions and compression.

UPS Worldwide Express Freight Midday and UPS Worldwide Express Freight shipments must be palletized, stackable, able to be lifted by forklift

and shrink-wrapped or banded to the pallet. For Air Freight or UPS Worldwide Expedited Ground Freight shipments, if your non-palletized shipment does not meet the minimum billable weight per piece, consider palletizing prior to UPS pickup.

Step by Step

The following are basic step-by-step instructions for palletizing your freight shipments.

1. Select Pallets.

- Choose pallets large enough to prevent overhang of shipment pieces
- Pallets must be sturdy enough to support the load
 - Select pallets with closely spaced pallet deck boards
 - Never exceed the rated capacity of your pallet
- Do not select pallets with broken boards or protruding nail heads

Palletizing Your Shipment

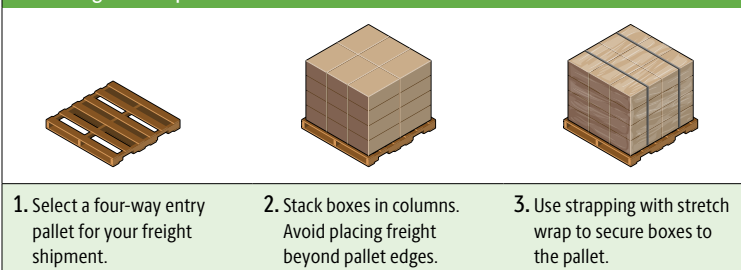

1. Select a four-way entry pallet for your freight shipment.

2. Stack boxes in columns. Avoid placing freight beyond pallet edges.

3. Use strapping with stretch wrap to secure boxes to the pallet.

- Pallets with four-way forklift entry are preferred as they help to improve handling and reduce damage to the shipment

2. Stack Boxes on Pallet.

For shipments that contain boxes or stackable pieces:

- Ensure cartons are new and of proper strength to withstand stacking

Many of The UPS Store® locations can handle LTL freight packaging and shipping for you. Visit theupsstore.com for more information.

Packaging Guidelines

UPS WORLDWIDE EXPRESS FREIGHT® MIDDAY, UPS WORLDWIDE EXPRESS FREIGHT®, UPS WORLDWIDE EXPEDITED® GROUND FREIGHT AND AIR FREIGHT

Step by Step (continued)

- Securely close, staple and/or seal cartons
- Protect product from internal vibration with proper amounts of dunnage within cartons; no void areas/spaces between product or on top of carton
- Remove old labels from shipping cartons and product
- Affix labels, with complete address information for the shipper and the consignee, to each piece
- Align boxes in columns, corner to corner, for the greatest stacking strength
- Avoid interlocking or rotating layer patterns
- Do not align corners over the spaces between pallet deck boards
- Boxes should not extend past the pallet edges
- Do not pyramid the boxes; keep the top layer flat to prevent damage from top loads
- Use a slip sheet under the load and every third layer when possible to help distribute the weight evenly and protect the bottom layer

3. Secure Shipment to Pallet.

- Use a minimum 60-gauge stretch wrap, five revolutions recommended; tie to pallet and across top to prevent shifting
- For Air Freight and UPS Worldwide Expedited Ground Freight, label all handling units with shipper/consignee information and PRO Numbers (at minimum all four vertical sides, interior and exterior of the stretch wrapping); use markers if having adhesion issues
- To ensure stability, corner boards and banding are recommended
- Use three-way locking, nailed corners (not staples) on crates; angle board must extend from the deck board to the top of the pallet load
- Insert layers of cardboard between layers of freight to absorb vibration; distribute the weight evenly

4. Label Shipment.

- For UPS Worldwide Express Freight Midday and UPS Worldwide Express Freight shipments, apply labels to each side of the pallet and on top of the pallet—each label should have telephone numbers and complete address information, including postal code of the shipper and the consignee
- For Air Freight and UPS Worldwide Expedited Ground Freight, label each pallet with telephone numbers and complete address information, including postal code of the shipper and the consignee
- Ensure information on the Bill of Lading (BOL) matches the shipment
- Indicate in proper location on the BOL and check contract/tariff for liability limits if excess declared value is needed
- Do not pyramid, ship or accept prohibited items or freight that overhangs the pallet

Protecting Your Palletized Shipment from Damage

Solution	Description
Corner/Edge Boards	<ul style="list-style-type: none"> – Increase vertical stacking strength, prevent damage to corner edges and stabilize the load – Should extend to the full height and length of the load and should be used on all corners
Strapping or Banding	<ul style="list-style-type: none"> – Prevents pieces from getting lost or separated from the load – Should be drawn tightly to the load, possibly requiring running it underneath the top deck boards of the pallet
Stretch Wrapping	<ul style="list-style-type: none"> – Use as an effective way to keep all pieces of a shipment together – Should first be applied around the pallet and continued upward around the load – Must be tight to prevent load shifting – Capture the pallet when wrapping bottom layer – Designed to stabilize the load, not to secure it to the pallet – Strapping or banding should be used in conjunction with stretch wrap to secure the load to the pallet
Top/Bottom Load Protector	<ul style="list-style-type: none"> – Layers of corrugated fiberboard or heavy paperboard – Use to help evenly distribute the weight of shipments that can be stacked upon one another

For additional assistance with freight packaging, email freight_testing@ups-psi.com or call 1-877-877-7229.

Packaging Guidelines

UPS WORLDWIDE EXPEDITED® GROUND FREIGHT AND AIR FREIGHT

Preparing Non-Palletized Freight

If you do not plan to secure your shipment to pallets, follow the steps below.

1. Ship freight in corrugated boxes (avoid reusing boxes), crates or shipping containers.
2. Use a container strong enough to support the weight of contents.

3. Use at least two inches of appropriate cushioning material to protect internal items from each other and the corners, sides, top and bottom of containers. Appropriate cushioning material would include corrugated fiberboard, multiple layers of folded newspaper, styrofoam sheets, packing blankets, etc.

4. Reinforce edges to protect from bending.

5. Securely seal closures and seams with reinforced tape.

6. Label each piece with telephone numbers and complete address information, including postal code of the shipper and the consignee.

Preparing for Pickup

Your freight pickup request is initiated when you Create a Shipment for freight using [ups.com](https://www.ups.com), WorldShip® or UPS® Forwarding Hub shipping tools.

Some Air Freight and UPS Worldwide Expedited Ground Freight shipment pickup requests require pre-authorization.

How to Label

Each piece of palletized or non-palletized freight must be clearly marked with telephone numbers and complete address information, including postal code of the shipper and the consignee. Indicate on freight labels if any pieces require C.O.D. service.

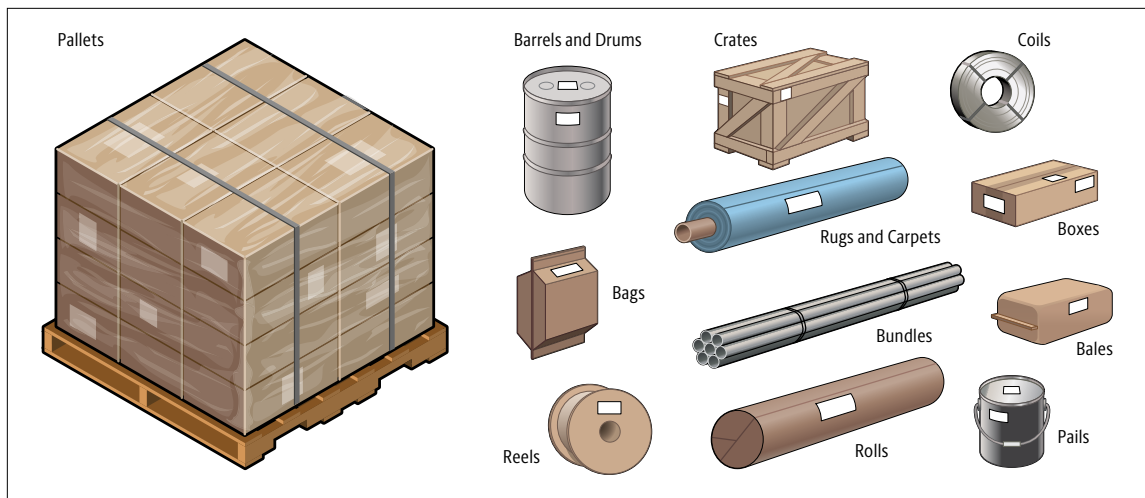

Note: UPS Worldwide Express Freight® Services do not accept non-palletized freight shipments.

Determine the Weight and Size

PACKAGE

For All Domestic and International Shipments

The “Determine the Weight and Size” information on this page and the next applies to package shipments only. For information on how to determine the weight and size for UPS Worldwide Express Freight® Midday and UPS Worldwide Express Freight® shipments, refer to page [20](#). For information on how to determine the weight and size for UPS® Simple Rate shipments, refer to page [74](#).

Shipping rates are based on package weight and size (explained below and on the following page) and origin-to-destination distance (refer to page [29](#) for Domestic, Export and Import).

Billable weight is the weight used to calculate the rate. For domestic and international services, the billable weight will be the greater of the dimensional weight compared to the actual weight.

How to determine billable weight:

1. Determine actual weight.

Actual weight is the package weight rounded up to the next whole pound.

Use a scale to determine the weight of the package. Round any fraction of a pound to the next whole pound for UPS Express® Envelopes (letters) over eight ounces and all other packages.

2. Determine dimensional weight.

Dimensional weight reflects package density, which is the amount of space a package occupies in relation to its actual weight. Dimensional weight may apply to all UPS domestic and international package services.

Determine the package dimensions in inches. For each dimension, measure at the longest point, rounding each measurement to the nearest whole number (for example, 1.00 to 1.49 will be considered 1, and 1.50 to 1.99 will be considered 2). The minimum measurement for each dimension is 1 inch.

Multiply the package length (longest side of the package) by the width by the height. The result is the cubic size in inches.

Divide the cubic size in inches by 139 to determine the dimensional weight in pounds. Increase any fraction to the next whole pound.

3. Determine billable weight.

Compare the package's actual weight to its dimensional weight. The greater of the two is the billable weight and should be used to calculate the rate.

For multiple-package shipments eligible for shipment pricing, total the billable weight of all packages in the shipment.

Notes:

- Shipment pricing is not available for a service unless specifically noted.
- For information on how to determine the rate applicable to UPS® Simple Rate shipments, see pages [74-75](#) and visit ups.com/simplerate.

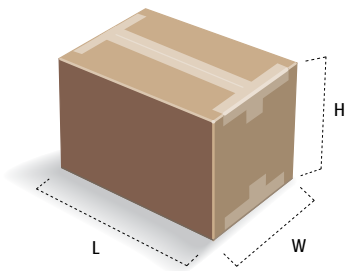

Dimensional Weight Calculation

$$\left[\begin{array}{l} \text{Dimensional Weight} \\ \text{in Pounds} \end{array} \right] = \frac{L \times W \times H}{139}$$

L = Length in inches

W = Width in inches

H = Height in inches

Determine the Weight and Size

PACKAGE

For All Domestic and International Shipments (continued)

Additional Information on Determining Weight and Size.

– **Letter rates** apply for domestic and international documents, correspondence and electronic media shipments that do not exceed eight ounces sent in a UPS Express® Envelope. Domestic Letters greater than eight ounces will be billed by weight (rounded up to the next whole pound). Export Letters greater than eight ounces and up to two pounds will be billed at UPS Express® Pak rates. Export Letters greater than two pounds and import Letters greater than eight ounces will be billed by weight (rounded up to the next whole pound).

– **UPS Express Pak rates** apply for export shipments that weigh two pounds or less, do not exceed \$100.00 in customs value and UPS Express Pak is selected at the time of shipping.

– Irregularly Shaped Packages:

If the package has a bulge or is irregularly shaped, measure the length, width and height of the package at its extreme points, which may include the bulge or irregular aspects of the package.

Treat the irregularly shaped package as if it were in a regular rectangular box. Measure the length, width and height of the package from its extreme points.

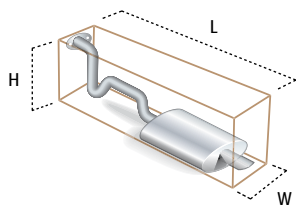

– Items Shipped in Bags:

Shape – When multiple items are shipped in a flexible container (e.g., burlap or plastic bag), the package measurements will be determined when the exterior is at rest. As this shape will differ from placement to placement, cubic size or package measurements will be made at the sole discretion of UPS.

Tails – A tail on an item shipped in a bag should be measured for the amount of space it takes up in a reasonably compressed fashion. Any tail that is created by placing an item in a bag must be compressed and taped to the body of the item.

– Packages that exceed UPS weight and size limits are not accepted for transportation. If found in the UPS system, they are subject to an Over Maximum Limits charge. UPS reserves the right in its sole and unlimited discretion to return such packages to the shipper at the shipper's expense. Refer to page 129 for more information. For Maximum Weight service restrictions, refer to page 8. For shipments over 150 pounds other than UPS Worldwide Express Freight® Services, refer to pages 76-77 for Air Freight, page 6 for Coyote Logistics® Truckload and page 15 for UPS Worldwide Expedited® Ground Freight for more information.

– A **Large Package Surcharge** may apply to domestic and international shipments.

For domestic shipments, a package is considered a “Large Package” when its length (longest side of the package)

plus girth [(2 x width) + (2 x height)] combined exceeds 130 inches or its length exceeds 96 inches.

For international shipments, a package is considered a “Large Package” when its length (longest side of the package) plus girth [(2 x width) + (2 x height)] combined exceeds 130 inches.

Large Packages are subject to a minimum billable weight of 90 pounds. See page 129 for applicable rates. An Additional Handling charge will not be assessed when a Large Package Surcharge is applied.

– Shippers are responsible for providing accurate and complete shipment information on the shipping document or in the automated processing system used, including service selected, number, weight and dimensions of packages. UPS reserves the right to audit any package and/or invoice to verify service selection, package dimensions or weight and applicability of any charges. As part of that audit, UPS may weigh and measure any package tendered to UPS using any method UPS deems appropriate, including, but not limited to, multi-dimensional measuring devices. If any aspect of the shipment information provided by the shipper is incomplete or incorrect as determined by UPS in its sole and unlimited discretion, UPS may in its sole and unlimited discretion adjust charges at any time.

Follow the instructions on this page and the previous page to determine the billable weight for your package shipments. Refer to page 20 for UPS Worldwide Express Freight Services.

Notes:

- Size limits indicated by a box manufacturer may not reflect exterior dimensions of a package, including where a package may have bulges or otherwise may not be uniform across each plane, and should not be used as a substitute for actual length, width and height measurements in determining dimensional weight.
- Improper packaging may result in the alteration of a package's dimensions during transit, which can affect the package's dimensional weight and result in a shipping charge correction.

To Destinations Worldwide

Determine the Weight and Size

UPS WORLDWIDE EXPRESS FREIGHT® MIDDAY AND UPS WORLDWIDE EXPRESS FREIGHT®

For International Palletized Shipments

Shipping rates are based on the shipment weight, including the weight of the pallet and size and origin-to-destination distance (refer to page 29 for Export and Import).

Billable weight is the weight used to calculate the rate. The billable weight will be the greater of the dimensional weight as compared to the actual weight.

How to determine billable weight:

1. Determine actual weight.

Actual weight is the weight of the items on the pallet and the weight of the pallet, rounded up to the next whole pound.

Use a scale to determine the weight. Round any fraction of a pound to the next whole pound.

2. Determine dimensional weight.

Dimensional weight reflects pallet density, which is the amount of space a pallet occupies in relation to its actual weight. Dimensional weight may apply to all UPS Worldwide Express Freight Midday or UPS Worldwide Express Freight shipments.

Determine the pallet dimensions in inches. For each dimension, measure at the longest point, rounding each measurement to the nearest whole number (for example, 1.00 to 1.49 will be considered 1, and 1.50 to 1.99 will be considered 2). The minimum measurement for each dimension is 1 inch.

Multiply the pallet length by the width and by the height. The result is the cubic size in inches.

For export and import shipments, divide the cubic size in inches by 139 to determine the dimensional weight. Increase any fraction to the next whole pound.

3. Determine billable weight.

Compare the pallet's actual weight to its dimensional weight. The greater of the two is the billable weight and should be used to calculate the rate.

Additional Information on Determining Size and Weight.

– Pallets that exceed maximum size or weight restrictions (which vary by origin and destination) as set forth at [ups.com/assets/resources/media/wwef_max_dim.pdf](https://www.ups.com/assets/resources/media/wwef_max_dim.pdf) require prior approval, and are subject to an Oversize Pallet Handling Surcharge. Refer to page 129 for more information.

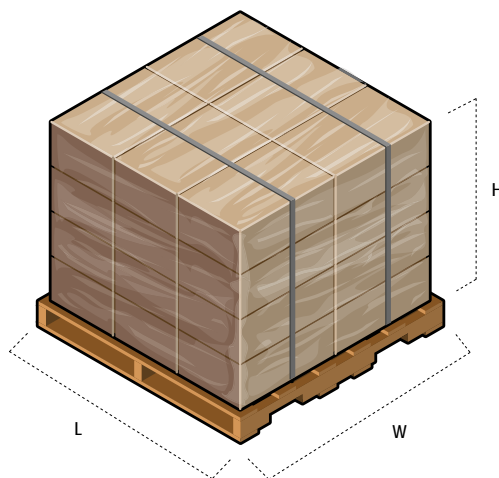

U.S. Export and Import

$$\left[\begin{array}{l} \text{Dimensional Weight} \\ \text{in Pounds} \end{array} \right] = \frac{L \times W \times H}{139}$$

L = Length in inches

W = Width in inches

H = Height in inches

Billable Weight Calculation

Customer has a shipment with three (3) pallets weighing 600 pounds, 800 pounds and 1,000 pounds. All pallets are the same size with the following dimensions: 48 in. x 40 in. x 60 in.

1. Determine actual weight.

$$\text{Actual Weight} = 600 \text{ lbs.} + 800 \text{ lbs.} + 1,000 \text{ lbs.} = 2,400 \text{ lbs.}$$

2. Determine dimensional weight.

$$\text{Pallet Dimensional Weight} = \frac{48 \text{ in.} \times 40 \text{ in.} \times 60 \text{ in.}}{139} = 829 \text{ lbs.}$$

$$\text{Shipment Dimensional Weight} = 829 \text{ lbs.} + 829 \text{ lbs.} + 1,000 \text{ lbs.} = 2,658 \text{ lbs.}$$

3. Determine billable weight.

$$\text{Shipment Billable Weight} = 2,658 \text{ lbs.}$$

To Destinations Worldwide

Determine the Weight and Size

AIR FREIGHT AND UPS WORLDWIDE EXPEDITED® GROUND FREIGHT

How to Determine Billable Weight*

Compare the freight shipment's minimum billable weight, actual weight and dimensional weight. The greatest of the three is the billable weight and should be used to calculate the rate.

1. Determine minimum billable shipment weight.*

- Minimum billable weight for loose items is the greater of minimum weight per shipment multiplied by the minimum weight per piece as set forth in the table below.

Service	Minimum Weight per Piece	Minimum Weight per Shipment
UPS Next Day Air® Freight	20 Pounds	151 Pounds
UPS Next Day Air® Freight NGS		
UPS 2nd Day Air® Freight		
UPS 2nd Day Air® Freight NGS		
UPS 3 Day Freight®		
UPS 3 Day Freight® NGS		
UPS Worldwide Expedited Ground Freight	N/A	551 Pounds

*The minimum billable shipment weight applies to all Air Freight services within and between the U.S., Canada and Puerto Rico. For UPS Worldwide Expedited Ground Freight, use minimum weight per shipment as defined above. For UPS Air Freight Direct® and UPS Air Freight Consolidated® services, a minimum shipment dollar amount is applied. Refer to the "UPS Air Freight Terms and Conditions of Contract for UPS Air Freight Services in the United States, Canada and International" at UPS Supply Chain Solutions, ups.com/freighttermsofservice or call 1-800-443-6379.

2. Determine actual weight and round up any fraction of a pound or kilogram to the next whole pound or kilogram.

3. Determine dimensional weight.

For each dimension, measure at the longest point, rounding each measurement to the nearest whole number. The minimum measurement for each dimension is 1 inch. Multiply the shipment length by the width by the height. The result is the cubic size. Divide the cubic size by the dimensional weight factor located in the matrix below to determine the dimensional weight.

Service	Origin	Destination	Dimensional Weight Factor (Inches/Pounds)	Dimensional Weight Factor (Centimeters/Kilograms)
UPS® Air Freight Premium Direct	All	All	139	5,000
UPS Air Freight Direct UPS Air Freight Consolidated	All	All	166	6,000
UPS Next Day Air Freight UPS Next Day Air Freight NGS UPS 2nd Day Air Freight UPS 2nd Day Air Freight NGS UPS 3 Day Freight UPS 3 Day Freight NGS	PR, CA and U.S.	PR, CA and U.S.	139	5,000
UPS Worldwide Expedited® Air Freight	U.S.	MX	139	5,000
	MX	U.S.		
UPS Worldwide Expedited Ground Freight	U.S.	MX		
	MX	U.S.		

To convert metric measurements into pounds, multiply the result by 2.20462. To convert imperial measurements into kilograms, multiply the result by 0.453592. Increase any fraction to the next whole pound or kilogram.

The chart on the next page provides examples of billable weight calculations for Air Freight shipments.

To Destinations Worldwide

Determine the Weight and Size

AIR FREIGHT

Examples on How to Determine Billable Weight for Air Freight Shipments*

Freight Billable Weight: Minimum Billable Shipment Weight – Within and Between the U.S., Canada and Puerto Rico											
Number of Pieces	Type	Length Each	Width Each	Height Each	Weight Each	Min. Billable Weight	Actual Weight	Dimensional Weight @ 139	Billable Weight		
5	Loose items	10"	10"	10"	20 lbs.	151 lbs.	100 lbs.	36 lbs.	151 lbs.		
Freight Billable Weight: Minimum Billable Weight Per Piece – Within and Between the U.S., Canada and Puerto Rico**											
Number of Pieces	Type	Length Each	Width Each	Height Each	Weight Each	Min. Billable Weight	Actual Weight	Dimensional Weight @ 139	Billable Weight		
20	Loose items	10"	10"	10"	15 lbs.	20 lbs.	300 lbs.	144 lbs.	400 lbs.		
Freight Billable Weight: Actual Weight											
Number of Pieces	Type	Length Each	Width Each	Height Each	Weight Each	Min. Billable Weight	Actual Weight	Dimensional Weight @ 166	Dimensional Weight @ 139	Billable Weight	
20	Loose items	10"	10"	10"	25 lbs.	151 lbs.	500 lbs.	121 lbs.	144 lbs.	500 lbs.	
Freight Billable Weight: Dimensional Weight											
Number of Pieces	Type	Length Each	Width Each	Height Each	Weight Each	Min. Billable Weight	Actual Weight	Dimensional Weight @ 166	Dimensional Weight @ 139	Billable Weight	
2	Loose items	30"	25"	20"	70 lbs.	151 lbs.	140 lbs.	181 lbs.	216 lbs.	216 lbs.	
Freight Billable Weight: Using a Pallet***											
Number of Pieces	Type	Length Each	Width Each	Height Each	Shipment Weight	Pallet Weight	Min. Billable Weight	Actual Weight	Dimensional Weight @ 166	Dimensional Weight @ 139	Billable Weight
1	Pallet	35"	35"	35"	315 lbs.	40 lbs.	151 lbs.	355 lbs.	259 lbs.	309 lbs.	355 lbs.

*The minimum billable shipment weight applies to all Air Freight services within and between the U.S., Canada and Puerto Rico. For UPS Air Freight Direct® and UPS Air Freight Consolidated® services, a minimum shipment dollar amount is applied. Refer to the "UPS Air Freight Terms and Conditions of Contract for UPS Air Freight Services in the United States, Canada and International" at UPS Supply Chain Solutions [ups.com/freighttermsofservice](https://www.ups.com/freighttermsofservice) for more information or call 1-800-443-6379.

**The minimum billable weight of 20 pounds per loose piece applies to Air Freight within and between the U.S., Canada and Puerto Rico only. If your non-palletized shipment does not meet the minimum weight of 20 pounds per piece, consider palletizing. Palletizing will ensure your shipment does not fall below the per-piece minimum billable charge.

***Pallet billable weight is equal to the shipment weight (315 pounds) plus the weight of a pallet (approximately 40 pounds).

Note: Each pallet with its secured contents is entered as one piece.

Shipping Solutions

Solution	Shipping Environment	Features and Benefits
AUTOMATED PROCESSING		
WorldShip® WorldShip.at.ups.com	Centralized Shipping (shipping room, warehouse)*	Full-featured Windows®-based software for customers with high-volume shipping needs: <ul style="list-style-type: none"> – Process UPS package and freight shipments using a single application to obtain a rate quote, schedule pickups, process paperless trade documentation, and track shipments. – Choose from several options for inputting shipment data, ranging from manual entry to fully automated, hands-free shipping. – Streamline shipment processing by customizing default settings to match your shipping preferences. – Connect WorldShip software to your accounting and customer service systems for seamless cross-functional communication. – Create custom labels with your company logo or promotional information.
ups.com shipping	Decentralized Shipping (distributed employees, front office, administrative staff, etc.)*	Print UPS labels from a secure online environment: <ul style="list-style-type: none"> – Web-based shipping system allows anyone in your company to ship from anywhere. – Process UPS package and freight shipments using a single application to obtain a rate quote, schedule pickups, process paperless trade documentation, and track shipments. – Simplify shipping with shipping preferences and the UPS address book. – View history, track and reprint your Air Freight and UPS Worldwide Expedited® Ground Freight waybill from one page. – Export your history to integrate with other systems. – No software or setup required. – Ship using a UPS account or a credit card or debit card or PayPal® account. – Complete a shipment without registering at ups.com shipping.
UPS CampusShip®	Decentralized Shipping with Centralized Control (distributed employees, front office, administrative staff, etc., with administrator controls)*	Gain control and reporting of your employees' shipping activities in a secure environment, controlled by an administrator: <ul style="list-style-type: none"> – A web-based shipping system that allows anyone in your company to ship or track from anywhere, but gives complete visibility and control to the shipping decision-maker. – Process UPS package and freight shipments using a single application to obtain a rate quote, schedule pickups, process paperless trade documentation and track shipments. – Ship UPS small package, freight, and international shipments using a shared address book for multiple users. – Export your history to integrate with other systems. – No software required. – Visit UPS CampusShip at ups.com, contact your local representative or call 1-800-PICK-UPS® (1-800-742-5877).
UPS Marketplace Shipping Solutions**	Decentralized Shipping solution powered by ups.com shipping (individual and small to medium businesses that sell on marketplaces)	A secure web-based shipping solution to easily view and ship all your online store orders from one location: <ul style="list-style-type: none"> – Automatically imports online orders from marketplaces or direct web stores to UPS Marketplace Shipping. – Simplified shipment processing (Amazon support limited to Professional sellers only). – Ability to sequentially process multiple shipments and combine orders from same buyer and marketplace. – Automatically uploads tracking information back to the online store after processing. – Visit UPS Marketplace Shipping Solutions for more information.
UPS® Forwarding Hub ups.com/forwardinghub	Decentralized Air and Ocean Freight Shipping	A web-based Air and Ocean Freight shipping site: <ul style="list-style-type: none"> – A one-stop source to quote, book and track shipments. – Create and upload shipping documents, manage tracking notifications and review historical quoting and booking data from a personalized dashboard. – Link Global Freight Forwarding account numbers to quote against pricing agreements and easily track active shipments.
Coyote Logistics® coyote.com	Truckload and Intermodal Freight Management Portal	Provides direct access for customers to create, view, track and settle their own loads, and for carriers to find, accept and update loads. <ul style="list-style-type: none"> – Network map includes filters to provide a focused, filtered view and ability to hover over lane to see lane information. – Streamlined accounting features allows for uploading paperwork, viewing invoices and checking accounting status. – Customizable load board allows users to add or remove columns to view the most valuable information. – Call 1-877-626-9683 or coyote.com/technology for more information.

*Applies to all UPS services except UPS Express Critical®, Truckload, Intermodal, Ocean Freight shipping. UPS® Simple Rate shipments may not be available through all UPS shipping systems.

**UPS Marketplace Shipping Solutions is not sponsored or endorsed by participating third-party marketplaces. Your use of the third-party marketplace remains subject to any applicable policies and terms and conditions of that third-party marketplace.

Notes:

- Hazardous Materials requiring shipping papers and International Dangerous Goods requiring a "Shipper's Declaration for Dangerous Goods" are not accepted through the UPS CampusShip shipping system.
- For Air Freight and UPS Worldwide Expedited Ground Freight services accessed through UPS CampusShip or ups.com shipping systems, a UPS call center or UPS Customer Center, a valid UPS six-character account number or a nine-digit UPS Supply Chain Solutions® account number is required.
- The UPS Ready® Program allows third-party business and shipping applications to integrate UPS technology, providing customers access to UPS products and services through out-of-the-box integrated solutions.

Shipping Solutions

Solution	Shipping Environment	Features and Benefits
AUTOMATED PROCESSING (continued)		
UPS® Mobile App for Android® and iOS® Devices*	Decentralized Mobile Package Shipping (distributed employees, professionals on the road)	<p>Supports shipments originating from 34 countries and territories. Create shipments when you are on the go:</p> <ul style="list-style-type: none"> – Process package shipments using supported smartphones. – Same login as ups.com shipping. – Access to ups.com shipping optimized for mobile users. – Use the stored information from your UPS address book, shipping and payment preferences. – Shipping label options include: email a shipping label, print from phone and mobile barcode. – Use your UPS account, credit card, debit card or electronic payment method. – Visit Mobile app at ups.com to learn more or download the app.
Coyote Logistics® CoyoteHOWL® Mobile App for Shippers	Mobile Truckload and Intermodal Shipping	<p>CoyoteHOWL mobile app is an internally developed, constantly evolving customer support tool that allows shippers to easily connect with their Coyote reps and access shipments, documents and business trends right from their mobile phones. It offers ability to receive load updates via push notifications and provides shippers free, on-the-go visibility 24/7. Visit noexcuses.coyote.com/CoyoteHOWL to learn more.</p>
UPS® Developer Kit	Integrated Enterprise and e-Commerce Applications**	<ul style="list-style-type: none"> – Suite of Application Programming Interfaces (APIs) that provides your programmers and integrators flexibility when integrating UPS shipping functionality directly into your business systems and websites. APIs improve efficiencies through automation of business processes: <ul style="list-style-type: none"> • Utilize XML and web services technologies. • Give you access to as many UPS services as you choose. – Other UPS Developer Kit APIs include Address Validation, Locator (and Plugin), Pickup, Quantum View®, Rating, Tracking, Time in Transit and UPS TradeAbility®
UPS Smart Label®	Provided by WorldShip®, ups.com shipping, UPS CampusShip® shipping systems, UPS® Developer Kit and UPS Ready® solutions	<p>UPS Smart Label data includes barcodes and routing codes that help ensure accurate routing and prompt delivery of your shipments. In addition, the use of UPS Smart Label technology allows for fast access to tracking and delivery information. We also offer printers for UPS Smart Label thermal printing. UPS account holders can rent a thermal label printer for \$3.00 per week by calling 1-800-PICK-UPS® (1-800-742-5877).</p>
Solution		
Features and Benefits		
MANUAL PROCESSING – PACKAGE		
Air Shipping Documents (ASDs)		<ul style="list-style-type: none"> – Available for UPS Next Day Air® Early, UPS Next Day Air®, UPS Next Day Air Saver®, UPS 2nd Day Air A.M.® and UPS 2nd Day Air® services. May also be used for UPS Worldwide Express® service. Does not apply to UPS® Simple Rate shipments. – To request an ASD, visit ups.com/shipping/order-supplies.page. – For Saturday Delivery, each UPS Express® Envelope or package must bear a Saturday Delivery routing label.
UPS 3 Day Select® and UPS® Ground Shipping Documents		<ul style="list-style-type: none"> – Attach the completed form to the package and schedule a pickup via ups.com. – A \$5.00 per-package Shipping Document Processing (SDP) fee applies whenever a shipping document is used for UPS 3 Day Select or UPS Ground shipments. – To request a shipping document, visit "Order Supplies" at ups.com/shipping/order-supplies.page. – Does not apply to UPS Simple Rate shipments.
UPS Worldwide Services Waybill		<ul style="list-style-type: none"> – Designed for international shipments: <ul style="list-style-type: none"> • Detailed information fields to fully address your shipment. • Various billing options to specify how payment of charges is handled. • Shipment-level detail enables shipment pricing and shipment tracking. • With proper authorization, U.S. Electronic Export Information (E.E.I.) will be filed electronically by UPS on your behalf. Refer to page 122 for fees. – When you use a UPS Worldwide Services Waybill for UPS Worldwide Express Freight® Midday or UPS Worldwide Express Freight® shipments, use one per shipment: <ul style="list-style-type: none"> • Packages within the pallet do not require an address label or UPS Worldwide Services Tracking Label. • For all shipments, call 1-800-782-7892 or go to ups.com to schedule pickup or drop-off. – When you use a UPS Worldwide Services Waybill for multiple-package or multiple-pallet shipments to the same recipient, only the lead package or pallet requires a waybill: <ul style="list-style-type: none"> • Each additional package or pallet must have an address label and a UPS Worldwide Services Tracking Label. • Detailed preparation instructions are printed on the reverse side of the waybill. – To request a UPS Worldwide Services Waybill, visit Order Supplies and Forms.

*Not available for UPS Worldwide Express Freight Services or UPS Simple Rate.

**Applies to all UPS services except UPS Express Critical®, Truckload, Intermodal, Ocean Freight or UPS Simple Rate shipments.

Note: Hazardous Materials and Dangerous Goods service is not available when using manual documentation (Air Freight is supported).

Pickup and Drop-off Availability

Arrange for a UPS Pickup

Method	Description
PACKAGE	
Scheduled Pickup*	<ul style="list-style-type: none"> – UPS offers the greatest number of reliable and convenient pickup options: <ul style="list-style-type: none"> • Daily Pickup • Daily On-Route Pickup • UPS Smart Pickup® service • Day-Specific Pickup – Refer to page 118 (domestic shipments). – Not available for UPS Worldwide Express Freight® Services.
UPS On-Call Pickup®	<p>With one pickup request, UPS will pick up all of your packages – Air, International, UPS 3 Day Select® and Ground services:</p> <ul style="list-style-type: none"> – Schedule a same-day or future-day pickup. – UPS On-Call Pickup service gives you the convenience of having your shipment picked up at a location of your choosing (not limited to home or office) by scheduling a pickup via ups.com. – Fees are applied per pickup request regardless of the number of packages being picked up. – Refer to page 114 for domestic and export shipment fees. <p>For UPS Worldwide Express Freight® Midday and UPS Worldwide Express Freight:</p> <ul style="list-style-type: none"> – Pickup or drop-off must be scheduled for each UPS Worldwide Express Freight Midday or UPS Worldwide Express Freight shipment via WorldShip® or UPS CampusShip® shipping systems, ups.com shipping, a UPS Ready® solution, UPS® Developer Kit, ups.com or by calling 1-800-782-7892. – UPS Worldwide Express Freight Midday and UPS Worldwide Express Freight pickups cannot be combined with Air, International or UPS 3 Day Select services package pickup. – No additional fees are applied for pickup requests.
AIR FREIGHT AND UPS WORLDWIDE EXPEDITED® GROUND FREIGHT	
UPS Supply Chain Solutions® Call Centers	<ul style="list-style-type: none"> – Call 1-800-443-6379 to schedule a pickup.
COYOTE LOGISTICS®	
Truckload and Intermodal	<ul style="list-style-type: none"> Call 1-877-626-9683 or visit coyote.com.

*Service for Hazardous Materials and International Dangerous Goods requiring shipping papers or "Shipper's Declaration for Dangerous Goods" is offered on a contractual basis. Only customers with a Scheduled Pickup account are eligible for these services. Such shipments may not be tendered to a Third-Party Retailer or UPS Access Point® Location. Please consult the Hazardous Materials Support Center at 1-800-554-9964 for specific regulatory and service-level requirements.

Pickup and Drop-off Availability

Find Locations for Package, UPS Worldwide Express Freight® Midday and UPS Worldwide Express Freight® Shipments

Location	Description
UPS Access Point® (in select areas only)	<p>UPS Access Point locations are select participating National Retail Partners, independently owned businesses or locations, including local businesses and The UPS Store® locations that offer drop-off of pre-paid UPS packages and, where available, package pickup.</p> <ul style="list-style-type: none"> – After a first unsuccessful delivery attempt to a consumer's home address, UPS may deliver eligible packages to a nearby UPS Access Point Location for the consumer to pick up. – Hours of operation vary by location (many UPS Access Point locations offer evening and weekend hours; visit ups.com for specific details). – Receiving packages: A government-issued photo ID will be required to collect the package. <p>Ship to a UPS Access Point Location Service:</p> <ul style="list-style-type: none"> – Available to all shippers with a valid UPS package account number. – Available with all UPS package shipping services* and most value-added services. – Shippers can integrate a UPS Locator into their e-commerce platforms, allowing their customers to select the UPS Access Point delivery location that is most convenient for them. – Only shippers with an approved UPS agreement for transportation of wine/beer/tobacco may ship wine/beer/tobacco to a UPS Access Point Location, subject to limitations set forth at ups.com/wine, ups.com/beer and ups.com/tobacco. – For more information and restrictions, go to: ups.com/media/en/ShiptoUPSAccessPointlocation_US_EN.pdf. <p>Additional Service Options for Shipment to a UPS Access Point Location:</p> <ul style="list-style-type: none"> – Deliver to Addressee Only – For added security, the shipment may only be picked up by the person identified on the shipping label (pickup by any third party is not permitted). – Package Release Code – For combined flexibility and security, enter a four- to six-digit numerical code when preparing a shipment and provide the code to the person you want to pick it up. The code is known only to you and the person you provide it to. <p>UPS Access Point Location Restrictions:</p> <ul style="list-style-type: none"> – All other packages cannot exceed 44 pounds in weight, the longest side must not exceed 38 inches, and the package must not exceed 130 inches in length plus girth combined. Drop-off packages at The UPS Store locations are subject to the maximum size and weight restrictions set forth in the "UPS Tariff/Terms and Conditions of Service – United States" available at ups.com/termsofservice. For a broader set of shipping solutions, visit your local The UPS Store. – Packages may not have a value of \$5,000.00 or more if delivered or shipped to a UPS Access Point Location or a value of \$1,000.00 or more if dropped off as pre-paid UPS packages. – Packages containing restricted or prohibited articles (e.g., hazardous materials requiring shipping papers, firearms, ammunition or weapons). Same restrictions apply to delivered packages, except for ammunition that meets requirements for Limited Quantity (Ltd Qty) packages and all other UPS requirements for ammunition shipments. – Except in limited circumstances, packages requiring an adult signature are permitted.*** – Shipper instructions may restrict eligibility.
The UPS Store®**	<ul style="list-style-type: none"> – Offers domestic and international shipping as well as the Pack & Ship Guarantee. – Access UPS® Simple Rate and UPS SurePost® shipments with a prepaid label. – More than 5,200 staffed locations. – Full portfolio of business services: packing services, packaging supplies, copying, printing, document finishing, mail and package solutions, faxing and office supplies. – International shipping expertise. – With certified packaging experts and the Pack & Ship Guarantee, participating locations will pack and ship your item via UPS, and if that item is damaged or lost in transit, you will be reimbursed. Visit theupsstore.com/guarantee for details. – Visit theupsstore.com to find a location.
UPS® Drop Box	<ul style="list-style-type: none"> – Use for all domestic and international packages. – Offers latest possible pickup times. – Approximately 26,000 locations. – Ground and Air packages shipped using UPS Returns® and UPS Import Control® services are accepted in any UPS Drop Box. – Packages and UPS Express® Envelopes with a value of more than \$500.00 cannot be shipped via a UPS Drop Box. – Maximum acceptable size for each UPS Drop Box package is 16" x 13" x 3". UPS Simple Rate shipments with a prepaid label are accepted. – Hazardous Materials/Dangerous Goods, including, but not limited to, Ltd Qty shipments prepared under HM-215K, are not accepted in any UPS Drop Box. – Self-service locations available 24 hours a day, seven days a week for your convenience.
UPS Customer Center	<ul style="list-style-type: none"> – UPS-staffed customer shipping locations. – Offers UPS domestic and international shipping as well as packaging supplies and packing services. – More than 800 locations. – Hold for Pickup† services available. – Accepts UPS Simple Rate shipments with a prepaid label.
UPS Worldwide Express Freight® Center	<ul style="list-style-type: none"> – UPS-staffed locations where shippers may tender international UPS Worldwide Express Freight Midday and UPS Worldwide Express Freight pallets to UPS for transportation and a consignee or other recipient may receive pallets. – UPS Worldwide Express Freight Midday and UPS Worldwide Express Freight shipments must be international, stackable, secured on a pallet and compliant with UPS packaging guidelines. – Pickup or drop-off must be scheduled for each UPS Worldwide Express Freight Midday or UPS Worldwide Express Freight shipment using WorldShip® or UPS CampusShip® shipping systems, ups.com shipping, a UPS Ready® solution, UPS® Developer Kit, ups.com or by calling 1-800-782-7892. – Hours of operation may vary by location. – Only UPS Worldwide Express Freight Midday and UPS Worldwide Express Freight shipments are accepted at these centers.
UPS Alliance Location (Staples)	<ul style="list-style-type: none"> – Offers exclusive access to UPS services. – Offers UPS domestic and international shipping. – More than 1,000 Staples locations. – Accepts UPS Simple Rate shipments with a prepaid label.
UPS Authorized Service Provider	<ul style="list-style-type: none"> – Third-party independent retailers that offer UPS domestic and international shipping. – Accepts UPS Simple Rate shipments with a prepaid label. – More than 2,200 locations. – Select locations also operate as UPS Access Point locations.
UPS Authorized Shipping Outlet	<ul style="list-style-type: none"> – Third-party pack-and-ship retailers that offer UPS domestic and international shipping. – Accepts UPS Simple Rate shipments with a prepaid label. – More than 3,600 locations. – Certain restrictions apply; refer to the "UPS Tariff/Terms and Conditions of Service – United States" available at ups.com/termsofservice for more information. – Select locations also operate as UPS Access Point locations.

*Not available for UPS Worldwide Express Freight Services.

**The UPS Store locations are independently owned and operated by licensed franchisees of The UPS Store, Inc., a subsidiary of United Parcel Service, Inc.

***For more information about adult signature, refer to page 116.

† Hold for Pickup available only at select UPS Customer Centers.

Notes:

– Visit "Locations" at [ups.com](https://www.ups.com).

– UPS Worldwide Express Freight Midday and UPS Worldwide Express Freight shipments are only accepted at UPS Worldwide Express Freight Centers.

How to Use This Guide

Section 1 CHOOSING A SERVICE PAGES [3-9](#)

Section 2 PREPARING A SHIPMENT PAGES [10-26](#)

Section 3

DETERMINING THE RATE

Determine the rates and zones for domestic, export and import shipments. Also, learn about value-added services that are available.

- Review the steps on how to determine the rates for your shipments. Pages [28-29](#)
 - Domestic, Export and Import – Determine the zone destination or origin for your shipment. Pages [30-45](#)
 - Domestic – Determine the UPS service rate for your domestic shipment. Pages [46-77](#)
 - Export – Determine the UPS service rate for your export shipment. Pages [78-95](#)
 - Import – Determine the UPS service rate for your import shipment. Pages [96-113](#)
 - Value-added services, other charges and customs brokerage services for domestic, export and import. Pages [114-143](#)
-

Section 4 TRACKING AND PAYMENT PAGES [144-149](#)

Domestic, Export and Import

Determine the Rate

All UPS rates are per package for domestic services and per shipment for international services, unless otherwise noted. The following information applies to the rate charts that appear on pages 46-73 for domestic and pages 79-111 for export and import. (Refer to pages 74-75 for UPS® Simple Rate shipments.)

Packages processed for shipment or tendered to UPS on Sundays, holidays or other non-operating days may, in UPS's discretion, be billed at the UPS rates in effect on the next UPS operating day.

Domestic, Export and Import

- Visit [ups.com](https://www.ups.com) for guarantee details, service availability, delivery time commitments or to request a pickup.
- Dimensional weight may apply. Refer to page 18 for more information.
- For large or heavy packages, additional charges may apply. Refer to pages 18-19 for large packages and page 12 for heavy packages.
- A Heavy Package sticker is required for any package weighing more than 70 pounds.
- UPS Worldwide Express Freight® services are available for shipments over 150 pounds that are palletized. See pages 82-83 or 100-101 for more information. For additional freight services refer to [ups.com/freight](https://www.ups.com/freight).
- Rates do not include a fuel surcharge. For current fuel surcharge rates, visit [ups.com/fuelsurcharge](https://www.ups.com/fuelsurcharge). Fuel surcharges do not apply to UPS Simple Rate shipments.
- Demand Surcharges apply to certain packages tendered during Demand Periods. The term Demand Surcharges includes Peak/Demand Surcharges and Peak Surcharges, and the terms are used interchangeably. See [ups.com/peaksurcharges](https://www.ups.com/peaksurcharges) for details.

Domestic

- For each UPS Next Day Air® Early package with a weight of more than 150 pounds, multiply the weight by the price per pound and add \$30.00. For all other UPS domestic services with a weight of more than 150 pounds, multiply the weight by the price per pound.
- The Letter rate applies only to documents, correspondence and electronic

media shipments that do not exceed eight ounces sent in a UPS Express® Envelope. UPS Express Envelopes exceeding eight ounces are subject to the rate corresponding to the weight of the UPS Express Envelope. UPS Express Envelopes are not recommended for shipments of electronic media containing sensitive personal information.

- Shipments of Hazardous Materials using UPS 3 Day Select® service must be prepared in accordance with the appropriate Air Dangerous Goods requirements. Hazardous Materials contract service is available with a Scheduled Pickup.
- UPS does not accept Hazardous Materials [including but not limited to Limited Quantity (Ltd Qty) and combustibles] in UPS® Ground service destined to and from Alaska; Hawaii; Puerto Rico; Avalon, CA; Catalina Island, CA; Beaver Island, MI; Mackinac Island, MI (winter only); the Bass Islands, OH; Kelleys Island, OH; and San Juan Islands, WA.

Export and Import

- Delivery times may vary by origin and destination postal code.
- The rates shown on pages 79-113 are for shipments originating in the U.S. (export) or destined to the U.S. (import) and billed to a U.S. UPS account number.
- Any fraction of a pound more than the weight shown in the rate chart is rounded up to the next listed weight.
- To determine the rate for international multiple-package shipments, refer to page 78 for export and page 96 for import.
- For UPS Worldwide Express Freight® Midday and UPS Worldwide Express Freight shipments, additional charges may apply to larger pallets. Refer to page 129 for more information. Shipments exceeding maximum size or weight restrictions require prior authorization.
- All UPS Worldwide Express Freight Midday and UPS Worldwide Express Freight shipments require a scheduled pickup or drop-off using WorldShip® or UPS CampusShip® shipping systems, ups.com shipping, a UPS Ready® solution, UPS® Developer Kit, [ups.com](https://www.ups.com) or calling 1-800-782-7892.

- When using a UPS® 10 KG Box or UPS® 25 KG Box, shipments that exceed the maximum weights (10 KG/22 pounds and 25 KG/55 pounds) will be charged the regular UPS Worldwide Express Plus®, UPS Worldwide Express® or UPS Worldwide Saver® rate. Available only when the shipper is paying the shipping charges.
- Shipments of Dangerous Goods using any UPS Worldwide Express®, UPS Worldwide Expedited® or UPS Worldwide Saver® Service must be prepared in accordance with the appropriate Air Dangerous Goods requirements. Dangerous Goods contract service is available with a Scheduled Pickup.

Export

- UPS Express® Pak rates will apply to Letters weighing more than eight ounces, but less than two pounds. UPS Express Pak rates also apply when all the following are met:
 - The shipment weighs two pounds or less (shipments above two pounds are rated by weight)
 - UPS Express Pak is selected at the time of shipping
 - The customs value of the shipment is less than \$100.00
- The Letter rate applies only to documents, correspondence and electronic media shipments of no commercial value that do not exceed eight ounces sent in a UPS Express Envelope. UPS Express Envelopes containing items other than those listed above or exceeding eight ounces up to two pounds are subject to the UPS Express Pak rate. Shipments greater than two pounds are subject to the rate corresponding to the weight. UPS Express Envelopes are not recommended for shipments of electronic media containing sensitive personal information.

Import

The Letter rate applies only to documents, correspondence and electronic media shipments of no commercial value that do not exceed eight ounces and are sent in a UPS Express Envelope. Shipments greater than eight ounces are subject to the rate corresponding to the weight. UPS Express Envelopes are not recommended for shipments of electronic media containing sensitive personal information.

Domestic, Export and Import

Determine the Rate and Zone

PACKAGE AND AIR FREIGHT

Determine the Rate

To determine the rate for domestic, export and import packages, including UPS Worldwide Express Freight® Midday, UPS Worldwide Express Freight® and Air Freight shipments, follow the steps below:

	Domestic	Export	Import	Air Freight
1. Choose service	page 4	page 4	page 4	page 5
2. Compute billable weight	pages 18-19	pages 18-20	pages 18-20	pages 21-22
3. Look up shipping zone	page 29	pages 29-40	pages 29-30 , pages 41-45	page 29

4. Calculate the rate: Use WorldShip® or UPS CampusShip® shipping systems, ups.com shipping, the UPS® App (package only), the UPS® Developer Kit, a UPS Ready® solution or the “Calculate Time and Cost” application on ups.com/ctc to see the rate for your shipment.*

OR

Follow the steps in the table below to use the rate charts in this guide:

	Domestic	Export	Import	Air Freight
1. Go to applicable rates for service option selected	pages 46-75	pages 78-95	pages 96-113	pages 76-77
2. Match billable weight to appropriate zone	page 29	pages 30-40	pages 30 , 41-45	pages 76-77
3. Additional charges may apply**	pages 114-130	pages 114-130	pages 114-130	pages 131-135

*Rates provided through UPS shipping systems are estimates only, and other shipping charges, surcharges and value-added service charges may apply based on your shipper characteristics and the characteristics of, and services requested for, shipments actually tendered to UPS.

**Including, but not limited to, surcharges if special options or value-added services are selected. Other surcharges, including surcharges imposed by carriers, also may apply for Air Freight. Contact your local UPS Supply Chain Solutions® service center for details (refer to ups.com/freightsurcharges at ups.com/supplychainsolutions).

Determine the Zone

Domestic (including Puerto Rico)

Use your UPS Zone Chart to determine the destination zone for the domestic package or Air Freight service option you've selected. View or download your UPS Zone Chart at ups.com/dailyratezones.

Export and Import

To find the destination zone that matches the service option you've selected, refer to the chart below.

Origin/Destination	Export	Import
48 Contiguous States	pages 30-34	pages 30 , 41-45
Canada	pages 30 , 35-39	page 44
Mexico	page 40	page 45

An Extended Area Surcharge may apply to certain destinations or origins within a country. Extended Area origins are subject to change. For the most current information, refer to ups.com/rates or call 1-800-782-7892.

Notes:

- Not applicable for UPS Express Critical®, UPS Worldwide Expedited® Ground Freight, Truckload, Intermodal, Ocean Freight, UPS Air Freight Direct®, UPS Air Freight Consolidated® or UPS® Simple Rate services.
- For information regarding pricing for UPS Simple Rate, refer to pages [74-75](#) and visit ups.com/simplerate.

West and East State Classifications

UPS WORLDWIDE EXPEDITED® AND UPS® STANDARD TO CANADA

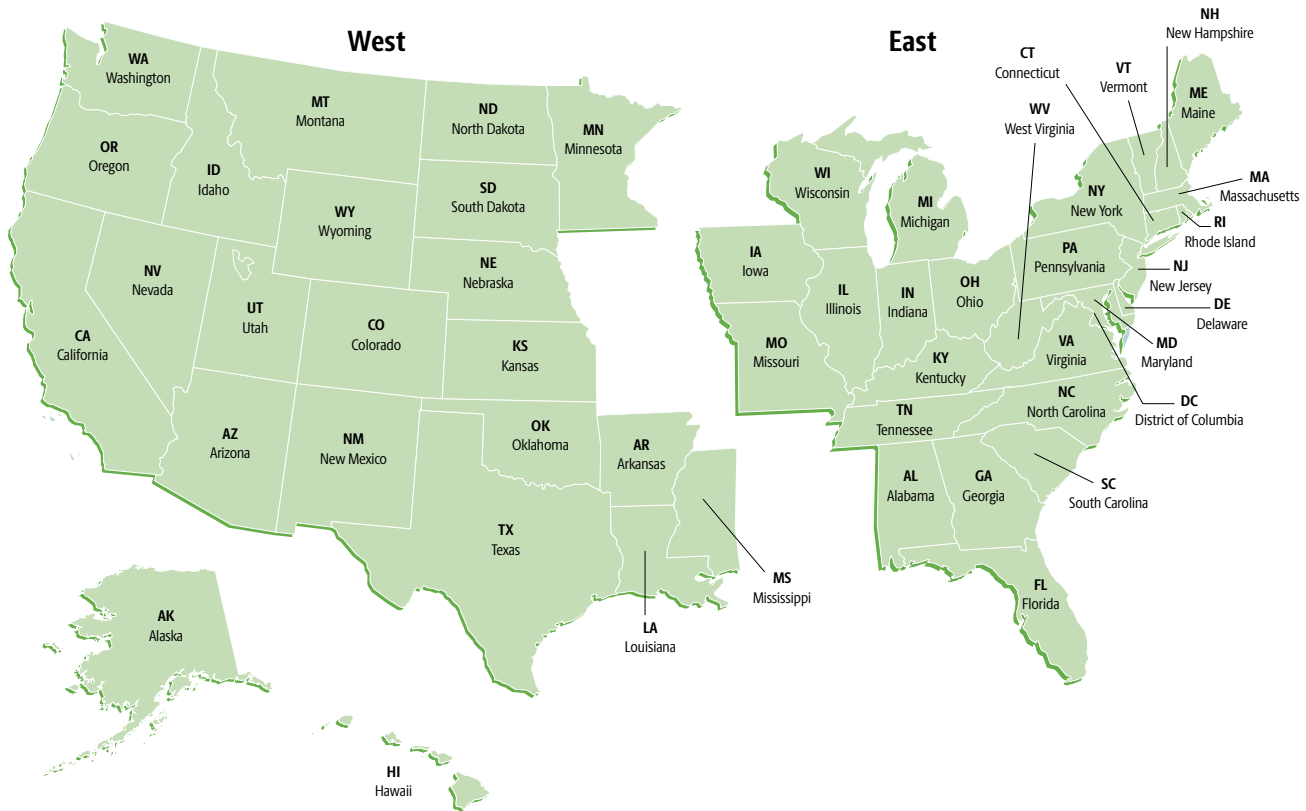

Use the map above to:

- Determine West and East origin state classifications for UPS Worldwide Expedited shipments.
- Identify state abbreviations for UPS Standard to Canada shipments.

Export

Worldwide Zone Chart

Destination	Zones						Destination	Zones					
	UPS Worldwide Express Plus®	UPS Worldwide Express®	UPS Worldwide Express Freight® Midday	UPS Worldwide Express Freight®	UPS Worldwide Saver®	UPS Worldwide Expedited®		UPS Worldwide Express Plus®	UPS Worldwide Express®	UPS Worldwide Express Freight® Midday	UPS Worldwide Express Freight®	UPS Worldwide Saver®	UPS Worldwide Expedited®
						WEST EAST						WEST EAST	
Afghanistan/AF					408	638 608	Bulgaria/BG	907	907			407	637 607
Aland Islands/AX					403	633 603	Burkina Faso/BF					408	638 608
Albania/AL	908	908			408	638 608	Burundi/BI					408	638 608
Algeria/DZ		908			408	638 608	Cambodia/KH		908			408	638 608
American Samoa/AS		908			408	638 608	Cameroon/CM					408	638 608
Andorra/AD		903			403	633 603	Canada/CA						
Angola/AO					408	638 608	<i>For Canada's Zone Chart, refer to pages 35-39.</i>						
Anguilla/AG†					402	632 602	Canary Islands (Spain)/ES					403	633 603
Antigua and Barbuda/AG†					402	632 602	Cape Verde/CV					408	638 608
Argentina/AR†		906		406	406	636 606	Cayman Islands/KY†					402	632 602
Armenia/AM	908	908			408	638 608	Central African Republic/CF					408	638 608
Aruba/AW†		902			402	632 602	Chad/TD					408	638 608
Australia/AU	904	904	404	404	404	634 604	Channel Islands Guernsey/ GG, Jersey/JE					403	633 603
Austria/AT	903	903	403	403	403	633 603	Chile/CL†		906	406	406	406	636 606
Azerbaijan/AZ					408	638 608	China, People's Republic of/CN	912	912		412	412	642 612
Azores (Portugal)/PT					403	633 603	Colombia/CO†		906		406	406	636 606
Bahamas/BS†		902			402	632 602	Comoros/KM					408	638 608
Bahrain/BH	905	905		405	405	635 605	Congo, Democratic Republic of/CD					408	638 608
Bangladesh/BD		911		411	411	641 611	Congo, Republic of/CG					408	638 608
Barbados/BB†		902			402	632 602	Costa Rica/CR†		906	406	406	406	636 606
Belarus/BY	908	908			408	638 608	Côte d'Ivoire (Ivory Coast)/CI					408	638 608
Belgium/BE	901	901	401	401	401	631 601	Croatia/HR		908			408	638 608
Belize/BZ†					406	636 606	Curaçao/CW†		902			402	632 602
Benin/BJ					408	638 608	Cyprus/CY	905	905			405	635 605
Bermuda/BM†		902			402	632 602	Czech Republic/CZ	907	907	407	407	407	637 607
Bolivia/BO†		906			406	636 606	Denmark/DK	903	903	403	403	403	633 603
Bonaire/BQ†					402	632 602	Djibouti/DJ		908			408	638 608
Bosnia/BA	908	908			408	638 608	Dominica/DM†					402	632 602
Botswana/BW					408	638 608	Dominican Republic/DO†		902		402	402	632 602
Brazil/BR†	906	906		406	406	636 606	Ecuador/EC†		906		406	406	636 606
British Virgin Islands/VG†					402	632 602	Egypt/EG		905		405	405	635 605
Brunei/BN		905			405	635 605							

† For shipments from Dade or Broward County, Florida, to South America, use zone:
 – 921 for UPS Worldwide Express
 – 421 for UPS Worldwide Express Freight Midday
 – 421 for UPS Worldwide Express Freight
 – 421 for UPS Worldwide Saver
 – 621 for UPS Worldwide Expedited

† For shipments from Dade or Broward County, Florida, to the Caribbean, use zone:
 – 920 for UPS Worldwide Express
 – 420 for UPS Worldwide Express Freight Midday
 – 420 for UPS Worldwide Express Freight
 – 420 for UPS Worldwide Saver
 – 620 for UPS Worldwide Expedited

Export

Worldwide Zone Chart

Destination	Zones							Destination	Zones						
	UPS Worldwide Express Plus®	UPS Worldwide Express®	UPS Worldwide Express Freight® Midday	UPS Worldwide Express Freight®	UPS Worldwide Saver®	UPS Worldwide Expedited®			UPS Worldwide Express Plus®	UPS Worldwide Express®	UPS Worldwide Express Freight® Midday	UPS Worldwide Express Freight®	UPS Worldwide Saver®	UPS Worldwide Expedited®	
						WEST	EAST							WEST	EAST
El Salvador/SV†				406	406	636	606	Hong Kong/HK	909	909	409	409	409	639	609
England (United Kingdom)/GB	901	901	401	401	401	631	601	Hungary/HU	907	907	407	407	407	637	607
Equatorial Guinea/GQ					408	638	608	Iceland/IS		903			403	633	603
Eritrea/ER					408	638	608	India/IN	911	911	411	411	411	641	611
Estonia/EE		907			407	637	607	Indonesia/ID	904	904		404	404	634	604
Ethiopia/ET					408	638	608	Iraq/IQ					408	638	608
Faeroe Islands (Denmark)/FO					403	633	603	Ireland, Republic of/IE	901	901	401	401	401	631	601
Finland/FI	903	903	403	403	403	633	603	Israel/IL		905	405	405	405	635	605
France/FR	901	901	401	401	401	631	601	Italy/IT	901	901	401	401	401	631	601
French Guiana/GF†		907			406	636	606	Ivory Coast (Côte d'Ivoire)/CI					408	638	608
Gabon/GA		908			408	638	608	Jamaica/JM†		902			402	632	602
Gambia/GM		908			408	638	608	Japan/JP	913	913	413	413	413	643	613
Georgia/GE	908	908			408	638	608	Jersey/JE		903			403	633	603
Germany/DE	901	901	401	401	401	631	601	Jordan/JO		905			405	635	605
Ghana/GH					408	638	608	Kazakhstan/KZ		908			408	638	608
Gibraltar/GI					408	638	608	Kenya/KE		908		408	408	638	608
Great Britain (United Kingdom)/GB	901	901	401	401	401	631	601	Korea, South/KR	913	913	413	413	413	643	613
Greece/GR		903	403	403	403	633	603	Kosovo/KV	908	908			408	638	608
Greenland (Denmark)/GL					403	633	603	Kuwait/KW	905	905		405	405	635	605
Grenada/GD†					402	632	602	Kyrgyzstan/KG		908			408	638	608
Guadeloupe/GP†		902			402	632	602	Laos/LA		908			408	638	608
Guam/GU		908			408	638	608	Latvia/LV		907			407	637	607
Guatemala/GT†		906		406	406	636	606	Lebanon/LB		905		405	405	635	605
Guernsey/GG		903			403	633	603	Lesotho/LS					408	638	608
Guinea/GN		908			408	638	608	Liberia/LR					408	638	608
Guinea-Bissau/GW					408	638	608	Libya/LY					408	638	608
Guyana/GY†					406	636	606	Liechtenstein/LI		903		403	403	633	603
Haiti/HT†					402	632	602	Lithuania/LT		907			407	637	607
Holland (Netherlands)/NL	901	901	401	401	401	631	601	Luxembourg/LU	901	901		401	401	631	601
Honduras/HN†		906		406	406	636	606	Macau/MO		904			404	634	604

† For shipments from Dade or Broward County, Florida, to South America, use zone:

- 921 for UPS Worldwide Express
- 421 for UPS Worldwide Express Freight Midday
- 421 for UPS Worldwide Express Freight
- 421 for UPS Worldwide Saver
- 621 for UPS Worldwide Expedited

† For shipments from Dade or Broward County, Florida, to the Caribbean, use zone:

- 920 for UPS Worldwide Express
- 420 for UPS Worldwide Express Freight Midday
- 420 for UPS Worldwide Express Freight
- 420 for UPS Worldwide Saver
- 620 for UPS Worldwide Expedited

Export

Worldwide Zone Chart

Destination	Zones							Destination	Zones						
	UPS Worldwide Express Plus®	UPS Worldwide Express®	UPS Worldwide Express Freight® Middy	UPS Worldwide Express Freight®	UPS Worldwide Saver®	UPS Worldwide Expedited®			UPS Worldwide Express Plus®	UPS Worldwide Express®	UPS Worldwide Express Freight® Middy	UPS Worldwide Express Freight®	UPS Worldwide Saver®	UPS Worldwide Expedited®	
						WEST	EAST							WEST	EAST
Macedonia (FYROM)/MK	908	908			408	638	608	Niger/NE		908			408	638	608
Madagascar/MG		908			408	638	608	Nigeria/NG	908	908		408	408	638	608
Madeira (Portugal)/PT					403	633	603	Norfolk Island/NF					408	638	608
Malawi/MW		908			408	638	608	Northern Ireland (United Kingdom)/GB	901	901		401	401	631	601
Malaysia/MY		904	404	404	404	634	604	Northern Mariana Islands/MP					408	638	608
Maldives/MV		908			408	638	608	Norway/NO	903	903		403	403	633	603
Mali/ML					408	638	608	Oman/OM		905		405	405	635	605
Malta/MT		908		408	408	638	608	Pakistan/PK		911		411	411	641	611
Martinique/MQ†					402	632	602	Panama/PA†		906		406	406	636	606
Mauritania/MR		908			408	638	608	Paraguay/PY†					406	636	606
Mauritius/MU		908		408	408	638	608	Peru/PE†		906			406	636	606
Mayotte/YT					408	638	608	Philippines/PH		904		404	404	634	604
Mexico/MX	84	84	484	484	484	74	74	Poland/PL	907	907	407	407	407	637	607
Moldova/MD	908	908			408	638	608	Portugal/PT	903	903	403	403	403	633	603
Monaco/MC		901		401	401	631	601	Puerto Rico/PR							
Mongolia/MN					408	638	608	<i>Refer to the UPS domestic rates beginning on page 46.</i>							
Montenegro/ME	908	908			408	638	608	Qatar/QA	905	905		405	405	635	605
Montserrat/MS†					402	632	602	Réunion/RE		908		408	408	638	608
Morocco/MA		908		408	408	638	608	Romania/RO	907	907		407	407	637	607
Mozambique/MZ					408	638	608	Rota (Northern Mariana Islands)/MP					408	638	608
Myanmar/MM		911			411	641	611	Russia/RU	907	907		407	407	637	607
Namibia/NA		908			408	638	608	Rwanda/RW					408	638	608
Nepal/NP		911			411	641	611	Saba/BQ†					402	632	602
Netherlands (Holland)/NL	901	901	401	401	401	631	601	Saipan (Northern Mariana Islands)/MP		908			408	638	608
Netherlands Antilles/AN† <i>Refer to Bonaire, St. Eustatius, Saba, Curaçao, St. Martin or St. Maarten for zone information.</i>								Samoa/WS		908			408	638	608
New Caledonia/NC		908			408	638	608	San Marino/SM				401	401	631	601
New Zealand/NZ		904		404	404	634	604	Saudi Arabia/SA	905	905		405	405	635	605
Nicaragua/NI†				406	406	636	606	Scotland (United Kingdom)/GB	901	901	401	401	401	631	601

† For shipments from Dade or Broward County, Florida, to South America, use zone:

- 921 for UPS Worldwide Express
- 421 for UPS Worldwide Express Freight Middy
- 421 for UPS Worldwide Express Freight
- 421 for UPS Worldwide Saver
- 621 for UPS Worldwide Expedited

For shipments from Dade or Broward County, Florida, to the Caribbean, use zone:

- 920 for UPS Worldwide Express
- 420 for UPS Worldwide Express Freight Middy
- 420 for UPS Worldwide Express Freight
- 420 for UPS Worldwide Saver
- 620 for UPS Worldwide Expedited

Export

Worldwide Zone Chart

Destination	Zones						Destination	Zones							
	UPS Worldwide Express Plus®	UPS Worldwide Express®	UPS Worldwide Express Freight® Midday	UPS Worldwide Express Freight®	UPS Worldwide Saver®	UPS Worldwide Expedited®		UPS Worldwide Express Plus®	UPS Worldwide Express®	UPS Worldwide Express Freight® Midday	UPS Worldwide Express Freight®	UPS Worldwide Saver®	UPS Worldwide Expedited®		
						WEST	EAST						WEST	EAST	
Senegal/SN		908			408	638	608	Tanzania/TZ					408	638	608
Serbia/RS	908	908			408	638	608	Thailand/TH	904	904	404	404	404	634	604
Seychelles/SC					408	638	608	Tinian (Northern Mariana Islands)/MP					408	638	608
Sierra Leone/SL					408	638	608	Togo/TG					408	638	608
Singapore/SG	909	909		409	409	639	609	Tortola (British Virgin Islands)/VG†					402	632	602
Slovakia/SK	907	907		407	407	637	607	Trinidad and Tobago/TT†		902			402	632	602
Slovenia/SI	907	907		407	407	637	607	Tunisia/TN		908		408	408	638	608
South Africa/ZA	907	907		407	407	637	607	Turkey/TR	905	905	405	405	405	635	605
Spain/ES	903	903	403	403	403	633	603	Turkmenistan/TM					408	638	608
Sri Lanka/LK		911		411	411	641	611	Turks and Caicos Islands/TC†					402	632	602
St. Barthélemy/BL†					402	632	602	Uganda/UG					408	638	608
St. Christopher (St. Kitts and Nevis)/KN†					402	632	602	Ukraine/UA	908	908			408	638	608
St. Croix (U.S. Virgin Islands)/VI†					402	632	602	Union Island (St. Vincent and the Grenadines)/VC†					402	632	602
St. Eustatius/BQ†					402	632	602	United Arab Emirates/AE	905	905	405	405	405	635	605
St. John (U.S. Virgin Islands)/VI†					402	632	602	United Kingdom/GB	901	901	401	401	401	631	601
St. Kitts and Nevis/KN†		902			402	632	602	Uruguay/UY†					406	636	606
St. Lucia/LC†		902			402	632	602	U.S. Virgin Islands/VI†					402	632	602
St. Maarten/SX†					402	632	602	Uzbekistan/UZ					408	638	608
St. Martin/SX†					402	632	602	Vatican City (Italy)/VA	901	901		401	401	631	601
St. Thomas (U.S. Virgin Islands)/VI†					402	632	602	Venezuela/VE†					406	636	606
St. Vincent and the Grenadines/VC†					402	632	602	Vietnam/VN	904	904		404	404	634	604
Suriname/SR†		906			406	636	606	Virgin Gorda (British Virgin Islands)/VG†					402	632	602
Swaziland/SZ					408	638	608	Wales (United Kingdom)/GB	901	901		401	401	631	601
Sweden/SE	903	903	403	403	403	633	603	Zaire (Congo, Democratic Republic of)/CD					408	638	608
Switzerland/CH	903	903	403	403	403	633	603	Zambia/ZM					408	638	608
Taiwan/TW	909	909	409	409	409	639	609	Zimbabwe/ZW					408	638	608
Tajikistan/TJ					408	638	608						408	638	608

† For shipments from Dade or Broward County, Florida, to South America, use zone:

- 921 for UPS Worldwide Express
- 421 for UPS Worldwide Express Freight Midday
- 421 for UPS Worldwide Express Freight
- 421 for UPS Worldwide Saver
- 621 for UPS Worldwide Expedited

† For shipments from Dade or Broward County, Florida, to the Caribbean, use zone:

- 920 for UPS Worldwide Express
- 420 for UPS Worldwide Express Freight Midday
- 420 for UPS Worldwide Express Freight
- 420 for UPS Worldwide Saver
- 620 for UPS Worldwide Expedited

Export Canada Zone Chart

Destination Postal Code Range	UPS Worldwide Express Plus® and UPS Worldwide Express®*	UPS Worldwide Express Freight® Midday and UPS Worldwide Express Freight®	UPS Worldwide Saver®	UPS Worldwide Expedited®	UPS® Standard to Canada by Origin State									
					CT, DC, DE, MA, MD, ME, NH, NJ, NY, PA, RI, VT, WV	AZ, CA, NV, UT	IL, IN, KY	IA, MN, WI	MI, OH	CO, MT, WY	ID, OR, WA	ND, NE, SD	NM, TX	AL, AR, FL, GA, KS, LA, MO, MS, NC, OK, SC, TN, VA
Newfoundland														
A0A - A0Z		481	481	71	54	56	55	55	54	56	56	55	56	55
A1A - A1N	82	482	482	72	54	56	55	55	54	56	56	55	56	55
A1P - A9Z	81	481	481	71	54	56	55	55	54	56	56	55	56	55
Nova Scotia														
B0A - B2T	81	481	481	71	54	56	55	55	54	56	56	55	56	55
B2V - B3B	82	482	482	72	54	56	55	55	54	56	56	55	56	55
B3C - B3G	81	481	481	71	54	56	55	55	54	56	56	55	56	55
B3H - B4B	82	482	482	72	54	56	55	55	54	56	56	55	56	55
B4C - B9Z	81	481	481	71	54	56	55	55	54	56	56	55	56	55
Prince Edward Island														
C0A - C0Z	81	481	481	71	54	56	55	55	54	56	56	55	56	55
C1A - C1E	82	482	482	72	54	56	55	55	54	56	56	55	56	55
C1G - C9Z	81	481	481	71	54	56	55	55	54	56	56	55	56	55
New Brunswick														
E0A - E0Z	81	481	481	71	54	56	55	55	54	56	56	55	56	55
E1A - E1G	82	482	482	72	54	56	55	55	54	56	56	55	56	55
E1H - E2G	81	481	481	71	54	56	55	55	54	56	56	55	56	55
E2H - E2S	82	482	482	72	54	56	55	55	54	56	56	55	56	55
E2T - E2Z	81	481	481	71	54	56	55	55	54	56	56	55	56	55
E3A - E3E	82	482	482	72	54	56	55	55	54	56	56	55	56	55
E3G - E9Z		481	481	71	54	56	55	55	54	56	56	55	56	55
Quebec														
G0A		482	482	72	51	53	52	52	51	53	53	52	53	52
G0B - G0J		481	481	71	54	56	55	55	54	56	56	55	56	55
G0K - G0L		482	482	72	54	56	55	55	54	56	56	55	56	55
G0M - G0S		482	482	72	51	53	52	52	51	53	53	52	53	52
G0T - G0W		481	481	71	54	56	55	55	54	56	56	55	56	55
G0X - G0Z		482	482	72	51	53	52	52	51	53	53	52	53	52
G1A - G3A	81	481	481	71	51	53	52	52	51	53	53	52	53	52
G3B - G3K		482	482	72	51	53	52	52	51	53	53	52	53	52
G3L - G4P		482	482	72	54	56	55	55	54	56	56	55	56	55
G4R - G4S		481	481	71	54	56	55	55	54	56	56	55	56	55
G4T - G4V		482	482	72	54	56	55	55	54	56	56	55	56	55

*To determine whether UPS Worldwide Express Plus and UPS Worldwide Express Services are available to your destination postal code, refer to ups.com or call 1-800-782-7892.

Export

Canada Zone Chart

Destination Postal Code Range	UPS Worldwide Express Plus® and UPS Worldwide Express®*	UPS Worldwide Express Freight® Midday and UPS Worldwide Express Freight®	UPS Worldwide Saver®	UPS Worldwide Expedited®	UPS® Standard to Canada by Origin State									
					CT, DC, DE, MA, MD, ME, NH, NJ, NY, PA, RI, VT, WV	AZ, CA, NV, UT	IL, IN, KY	IA, MN, WI	MI, OH	CO, MT, WY	ID, OR, WA	ND, NE, SD	NM, TX	AL, AR, FL, GA, KS, LA, MO, MS, NC, OK, SC, TN, VA
Quebec (cont.)														
G4W - G4Z		481	481	71	54	56	55	55	54	56	56	55	56	55
G5A		482	482	72	51	53	52	52	51	53	53	52	53	52
G5B - G5T		481	481	71	54	56	55	55	54	56	56	55	56	55
G5V - G6A		482	482	72	51	53	52	52	51	53	53	52	53	52
G6B		481	481	71	51	53	52	52	51	53	53	52	53	52
G6C - G6J		482	482	72	51	53	52	52	51	53	53	52	53	52
G6K		481	481	71	51	53	52	52	51	53	53	52	53	52
G6L - G6T		482	482	72	51	53	52	52	51	53	53	52	53	52
G6V - G6Z		481	481	71	51	53	52	52	51	53	53	52	53	52
G7A		481	481	71	54	56	55	55	54	56	56	55	56	55
G7B - G8P		481	481	71	54	56	55	55	54	56	56	55	56	55
G8R - G8S		482	482	72	54	56	55	55	54	56	56	55	56	55
G8T - G9Z		482	482	72	51	53	52	52	51	53	53	52	53	52
H0A - H0L		481	481	71	51	53	52	52	51	53	53	52	53	52
H0M		481	481	71	54	56	55	55	54	56	56	55	56	55
H0N - H9Z	81	481	481	71	51	53	52	52	51	53	53	52	53	52
J0A - J0L		482	482	72	51	53	52	52	51	53	53	52	53	52
J0M		481	481	71	54	56	55	55	54	56	56	55	56	55
J0N - J0V		482	482	72	51	53	52	52	51	53	53	52	53	52
J0W - J0Z		481	481	71	54	56	55	55	54	56	56	55	56	55
J1A - J3C	82	482	482	72	51	53	52	52	51	53	53	52	53	52
J3E		481	481	71	51	53	52	52	51	53	53	52	53	52
J3G - J3S		482	482	72	51	53	52	52	51	53	53	52	53	52
J3T - J3V		481	481	71	51	53	52	52	51	53	53	52	53	52
J3W - J3X		482	482	72	51	53	52	52	51	53	53	52	53	52
J3Y - J5R	81	481	481	71	51	53	52	52	51	53	53	52	53	52
J5S - J5X		482	482	72	51	53	52	52	51	53	53	52	53	52
J5Y - J7H	81	481	481	71	51	53	52	52	51	53	53	52	53	52
J7J - J7N	82	482	482	72	51	53	52	52	51	53	53	52	53	52
J7P - J7W	81	481	481	71	51	53	52	52	51	53	53	52	53	52
J7X - J8N	82	482	482	72	51	53	52	52	51	53	53	52	53	52
J8P - J9C	81	481	481	71	51	53	52	52	51	53	53	52	53	52
J9E		482	482	72	54	56	55	55	54	56	56	55	56	55
J9G - J9J		482	482	72	51	53	52	52	51	53	53	52	53	52
J9K - J9Z		481	481	71	54	56	55	55	54	56	56	55	56	55

*To determine whether UPS Worldwide Express Plus and UPS Worldwide Express Services are available to your destination postal code, refer to [ups.com](https://www.ups.com) or call 1-800-782-7892.

Export Canada Zone Chart

Destination Postal Code Range	UPS Worldwide Express Plus® and UPS Worldwide Express®*	UPS Worldwide Express Freight® Midday and UPS Worldwide Express Freight®	UPS Worldwide Saver®	UPS Worldwide Expedited®	UPS® Standard to Canada by Origin State									
					CT, DC, DE, MA, MD, ME, NH, NJ, NY, PA, RI, VT, WV	AZ, CA, NV, UT	IL, IN, KY	IA, MN, WI	MI, OH	CO, MT, WY	ID, OR, WA	ND, NE, SD	NM, TX	AL, AR, FL, GA, KS, LA, MO, MS, NC, OK, SC, TN, VA
Ontario														
K0A - K0H		482	482	72	51	53	51	52	51	53	53	52	53	52
K0J		481	481	71	54	56	54	55	54	56	56	55	56	55
K0K - K0Z		482	482	72	51	53	51	52	51	53	53	52	53	52
K1A - K4A	81	481	481	71	51	53	51	52	51	53	53	52	53	52
K4B - K7T	82	482	482	72	51	53	51	52	51	53	53	52	53	52
K7V - K8H		482	482	72	54	56	54	55	54	56	56	55	56	55
K8J - L1E	82	482	482	72	51	53	51	52	51	53	53	52	53	52
L1F - L1Z	81	481	481	71	51	53	51	52	51	53	53	52	53	52
L2A - L2C		482	482	72	51	53	51	52	51	53	53	52	53	52
L2E - L2W	81	481	481	71	51	53	51	52	51	53	53	52	53	52
L2X - L3N		482	482	72	51	53	51	52	51	53	53	52	53	52
L3P - L3T	81	481	481	71	51	53	51	52	51	53	53	52	53	52
L3V - L3W		482	482	72	51	53	51	52	51	53	53	52	53	52
L3X - L4L	81	481	481	71	51	53	51	52	51	53	53	52	53	52
L4M - L4R	82	482	482	72	51	53	51	52	51	53	53	52	53	52
L4S - L9T	81	481	481	71	51	53	51	52	51	53	53	52	53	52
L9V - L9Z		482	482	72	51	53	51	52	51	53	53	52	53	52
M0A - M9Z	81	481	481	71	51	53	51	52	51	53	53	52	53	52
N0A - N1A	82	482	482	72	51	53	51	52	51	53	53	52	53	52
N1B - N2Y	81	481	481	71	51	53	51	52	51	53	53	52	53	52
N2Z	82	482	482	72	51	53	51	52	51	53	53	52	53	52
N3A - N3V	81	481	481	71	51	53	51	52	51	53	53	52	53	52
N3W - N5T	82	482	482	72	51	53	51	52	51	53	53	52	53	52
N5V - N6N	81	481	481	71	51	53	51	52	51	53	53	52	53	52
N6P - N8M		482	482	72	51	53	51	52	51	53	53	52	53	52
N8N - N9K	81	481	481	71	51	53	51	52	51	53	53	52	53	52
N9L - N9Z		482	482	72	51	53	51	52	51	53	53	52	53	52
P0A - P0Z		481	481	71	54	56	54	55	54	56	56	55	56	55
P1A - P2M		482	482	72	54	56	54	55	54	56	56	55	56	55
P2N		481	481	71	54	56	54	55	54	56	56	55	56	55
P2P - P3K		482	482	72	54	56	54	55	54	56	56	55	56	55
P3L		481	481	71	54	56	54	55	54	56	56	55	56	55
P3M		482	482	72	54	56	54	55	54	56	56	55	56	55
P3N - P3P		481	481	71	54	56	54	55	54	56	56	55	56	55

*To determine whether UPS Worldwide Express Plus and UPS Worldwide Express Services are available to your destination postal code, refer to ups.com or call 1-800-782-7892.

Determining the Rate

Export

Canada Zone Chart

Destination Postal Code Range	UPS Worldwide Express Plus® and UPS Worldwide Express®**	UPS Worldwide Express Freight® Midday and UPS Worldwide Express Freight®	UPS Worldwide Saver®	UPS Worldwide Expedited®	UPS® Standard to Canada by Origin State									
					CT, DC, DE, MA, MD, ME, NH, NJ, NY, PA, RI, VT, WV	AZ, CA, NV, UT	IL, IN, KY	IA, MN, WI	MI, OH	CO, MT, WY	ID, OR, WA	ND, NE, SD	NM, TX	AL, AR, FL, GA, KS, LA, MO, MS, NC, OK, SC, TN, VA
Ontario (cont.)														
P3R - P4M		482	482	72	54	56	54	55	54	56	56	55	56	55
P4N - P4R		481	481	71	54	56	54	55	54	56	56	55	56	55
P4S - P4Z		482	482	72	54	56	54	55	54	56	56	55	56	55
P5A		481	481	71	54	56	54	55	54	56	56	55	56	55
P5B - P5M		482	482	72	54	56	54	55	54	56	56	55	56	55
P5N		481	481	71	54	56	54	55	54	56	56	55	56	55
P5P - P8M		482	482	72	54	56	54	55	54	56	56	55	56	55
P8N		481	481	71	54	56	54	55	54	56	56	55	56	55
P8P - P8S		482	482	72	54	56	54	55	54	56	56	55	56	55
P8T		481	481	71	54	56	54	55	54	56	56	55	56	55
P8V - P8Z		482	482	72	54	56	54	55	54	56	56	55	56	55
P9A		481	481	71	54	56	54	55	54	56	56	55	56	55
P9B - P9M		482	482	72	54	56	54	55	54	56	56	55	56	55
P9N		481	481	71	54	56	54	55	54	56	56	55	56	55
P9P - P9Z		482	482	72	54	56	54	55	54	56	56	55	56	55
Manitoba														
R0A - R2B		481	481	71	55	56	54	54	54	55	55	54	55	55
R2C - R4A	81	481	481	71	52	53	51	51	51	52	52	51	52	52
R4B - R9Z		481	481	71	55	56	54	54	54	55	55	54	55	55
Saskatchewan														
S0A - S0Z		481	481	71	55	56	54	54	54	55	55	54	55	55
S1A - S3M		482	482	72	55	56	54	54	54	55	55	54	55	55
S3N		481	481	71	55	56	54	54	54	55	55	54	55	55
S3P - S3Z		482	482	72	55	56	54	54	54	55	55	54	55	55
S4A		481	481	71	55	56	54	54	54	55	55	54	55	55
S4B - S4G		482	482	72	55	56	54	54	54	55	55	54	55	55
S4H		481	481	71	55	56	54	54	54	55	55	54	55	55
S4J - S4M		482	482	72	55	56	54	54	54	55	55	54	55	55
S4N - S4Z		482	482	72	52	53	51	51	51	52	52	51	52	52
S5A - S7G		481	481	71	55	56	54	54	54	55	55	54	55	55
S7H - S7V		481	481	71	52	53	51	51	51	52	52	51	52	52
S7W - S9Z		481	481	71	55	56	54	54	54	55	55	54	55	55

*To determine whether UPS Worldwide Express Plus and UPS Worldwide Express Services are available to your destination postal code, refer to [ups.com](https://www.ups.com) or call 1-800-782-7892.

Export

Canada Zone Chart

Destination Postal Code Range	UPS Worldwide Express Plus® and UPS Worldwide Express®*	UPS Worldwide Express Freight® Midday and UPS Worldwide Express Freight®	UPS Worldwide Saver®	UPS Worldwide Expedited®	UPS® Standard to Canada by Origin State									
					CT, DC, DE, MA, MD, ME, NH, NJ, NY, PA, RI, VT, WV	AZ, CA, NV, UT	IL, IN, KY	IA, MN, WI	MI, OH	CO, MT, WY	ID, OR, WA	ND, NE, SD	NM, TX	AL, AR, FL, GA, KS, LA, MO, MS, NC, OK, SC, TN, VA
Alberta														
T0A - T0B		481	481	71	56	55	56	56	56	55	54	55	56	56
T0C		482	482	72	53	52	53	53	53	52	51	52	53	53
T0E - T1W		481	481	71	56	55	56	56	56	55	54	55	56	56
T1X		481	481	71	56	55	56	56	56	55	54	55	56	56
T1Y - T3Z	81	481	481	71	53	52	53	53	53	52	51	52	53	53
T4A - T4Z		482	482	72	53	52	53	53	53	52	51	52	53	53
T5A - T6V	81	481	481	71	53	52	53	53	53	52	51	52	53	53
T6W - T6X		481	481	71	56	55	56	56	56	55	54	55	56	56
T6Y - T7W		481	481	71	56	55	56	56	56	55	54	55	56	56
T7X - T8N	82	482	482	72	53	52	53	53	53	52	51	52	53	53
T8P - T8Z		481	481	71	56	55	56	56	56	55	54	55	56	56
T9A - T9E		482	482	72	53	52	53	53	53	52	51	52	53	53
T9G - T9Z		481	481	71	56	55	56	56	56	55	54	55	56	56
British Columbia														
V0A - V0L		481	481	71	56	55	56	56	56	55	54	55	56	56
V0M		481	481	71	53	52	53	53	53	52	51	52	53	53
V0N - V1L		481	481	71	56	55	56	56	56	55	54	55	56	56
V1M		481	481	71	53	52	53	53	53	52	51	52	53	53
V1N - V2R		481	481	71	56	55	56	56	56	55	54	55	56	56
V2S - V2V		481	481	71	56	55	56	56	56	55	54	55	56	56
V2W - V3E	81	481	481	71	53	52	53	53	53	52	51	52	53	53
V3G		481	481	71	56	55	56	56	56	55	54	55	56	56
V3H - V7Z	81	481	481	71	53	52	53	53	53	52	51	52	53	53
V8A - V8K		481	481	71	56	55	56	56	56	55	54	55	56	56
V8L - V9E	82	482	482	72	53	52	53	53	53	52	51	52	53	53
V9G - V9Z		481	481	71	56	55	56	56	56	55	54	55	56	56
Nunavut														
X0A - X0C		481	481		-	-	-	-	-	-	-	-	-	-
Northwest Territories														
X0E - X9Z		481	481		-	-	-	-	-	-	-	-	-	-
Yukon														
Y0A - Y9Z	81	481	481		-	-	-	-	-	-	-	-	-	-

*To determine whether UPS Worldwide Express Plus and UPS Worldwide Express Services are available to your destination postal code, refer to [ups.com](https://www.ups.com) or call 1-800-782-7892.

Note: UPS Standard is not available to Nunavut, the Northwest Territories or Yukon.

Export

UPS® Standard Zone Chart

SHIPMENTS TO MEXICO

U.S. Origin ZIP Code	Standard Zone
00400-00599	37
01000-03999	37
04000-04999	38
05000-08999	37
10000-14699	37
14700-14799	36
14800-14999	37
15000-16899	36
16900-17299	37
17300-17499	36
17500-19999	37
20000-20999	36
24000-28699	36
28700-28999	35
29000-29599	36
29600-29699	35
29700-29799	36
29800-29899	35
29900-29999	36
30000-31299	35
31300-31499	36
31500-32699	35
32700-33499	36
33500-33899	35
33900-33999	36
34100-34199	36
34200-34699	35
34700-34999	36
35000-36499	35
36500-36699	34
36700-36899	35
36900-36999	34
37000-37599	35
37600-37699	36
37700-38699	35
38700-38799	34
38800-38899	35
38900-39699	34
39700-40999	35
41000-41299	36

U.S. Origin ZIP Code	Standard Zone
41300-41499	35
41500-41899	36
42000-42799	35
43000-45999	36
46000-46299	35
46300-46899	36
46900-46999	35
47000-47099	36
47100-47299	35
47300-47399	36
47400-47999	35
48000-49999	36
50000-52099	35
52100-52199	36
52200-52899	35
53000-53799	36
53800-53899	35
53900-56099	36
56100-56199	35
56200-56799	36
57000-57199	35
57200-57299	36
57300-57399	35
57400-59399	36
59400-59699	37
59700-59799	36
59800-59999	37
60000-60899	36
60900-60999	35
61000-61199	36
61200-64799	35
64800-64899	34
64900-65599	35
65600-65999	34
66000-66699	35
66700-66799	34
66800-66999	35
67000-67399	34
67400-67799	35
67800-67999	34

U.S. Origin ZIP Code	Standard Zone
68000-69399	35
70000-70599	34
70600-70699	33
70700-72299	34
72300-72499	35
72500-73299	34
73300-73399	32
73400-74999	34
75000-75499	33
75500-75599	34
75600-76499	33
76500-76599	32
76600-77799	33
77800-78499	32
78500-78599	33
78600-78999	32
79000-79499	34
79500-79799	33
79800-79999	34
80000-82099	35
82100-82199	36
82200-82399	35
82400-83499	36
83500-83599	37
83600-83799	36
83800-83899	37
84000-84499	36
84500-84599	35
84600-84799	36
85000-86399	35
86400-86499	36
86500-87599	35
87700-88599	34
88900-93899	36
93900-96099	37
96100-96199	36
97000-97899	37
97900-97999	36
98000-98699	37
98800-99499	37

Import

Worldwide Zone Chart

Origin	Zones						UPS Worldwide Expedited*	WEST	EAST	Origin	Zones						UPS Worldwide Expedited*	WEST	EAST
	UPS Worldwide Express Plus®	UPS Worldwide Express®	UPS Worldwide Express Freight® Midday	UPS Worldwide Express Freight®	UPS Worldwide Saver®						UPS Worldwide Express Plus®	UPS Worldwide Express®	UPS Worldwide Express Freight® Midday	UPS Worldwide Express Freight®	UPS Worldwide Saver®				
Afghanistan/AF	958	958			458				Canada/CA										
Aland Islands/AX	953	953			453				For UPS 3 Day Select® and UPS® Standard zones, refer to page 44.	91	91	491	491	491	61	61			
Albania/AL	958	958			458				Canary Islands (Spain)/ES	953	953			453					
Algeria/DZ	958	958			458				Cape Verde/CV	958	958			458					
American Samoa/AS	958	958			458				Cayman Islands/KY†	952	952			452					
Angola/AO	958	958			458				Chad/TD	958	958			458					
Anguilla/AI†	952	952			452				Channel Islands Guernsey/ GG, Jersey/JE	953	953			453	683	653			
Antigua and Barbuda/AG†	952	952			452				Chile/CL†	956	956	456	456	456	686	656			
Argentina/AR†	956	956	456	456	456	686	656		China, People's Republic of/CN	962	962	462	462	462	692	662			
Armenia/AM	958	958			458				Colombia/CO†	956	956	456	456	456	686	656			
Aruba/AW†	952	952			452				Comoros/KM	958	958			458					
Australia/AU	954	954	454	454	454	684	654		Congo, Democratic Republic of/CD	958	958			458					
Austria/AT	953	953	453	453	453	683	653		Congo, Republic of/CG	958	958			458					
Azerbaijan/AZ	958	958			458				Costa Rica/CR†	956	956	456	456	456	686	656			
Azores (Portugal)/PT	953	953			453	683	653		Côte d'Ivoire (Ivory Coast)/CI	958	958			458					
Bahamas/BS†	952	952			452				Croatia/HR	958	958			458					
Bahrain/BH	955	955	455	455	455	685	655		Curaçao/CW†	952	952			452					
Bangladesh/BD	961	961	461	461	461				Cyprus/CY	955	955			455					
Barbados/BB†	952	952			452				Czech Republic/CZ	957	957	457	457	457	687	657			
Belarus/BY	958	958			458				Denmark/DK	953	953	453	453	453	683	653			
Belgium*/BE	951	951	451	451	451	681	651		Djibouti/DJ	958	958			458					
Benin/BJ	958	958			458				Dominica/DM†	952	952			452					
Bermuda/BM†	952	952			452				Dominican Republic/DO†	952	952	452	452	452	682	652			
Bolivia/BO†	956	956			456				Ecuador/EC†	956	956	456	456	456	686	656			
Bonaire/BQ†	952	952			452				Egypt/EG	955	955		455	455	685	655			
Bosnia/BA	958	958			458				El Salvador/SV†	956	956	456	456	456	686	656			
Botswana/BW	958	958			458				England (United Kingdom)*/GB	951	951	451	451	451	681	651			
Brazil/BR†	956	956	456	456	456	686	656		Eritrea/ER	958	958			458					
British Virgin Islands/VG†	952	952			452				Estonia/EE	957	957			457	687	657			
Brunei/BN	955	955			455				Ethiopia/ET	958	958			458					
Bulgaria/BG	957	957	457	457	457	687	657		Finland/FI	953	953	453	453	453	683	653			
Burkina Faso/BF	958	958			458				France/FR	951	951	451	451	451	681	651			
Burundi/BI	958	958			458				Gabon/GA	958	958			458					
Cambodia/KH	958	958			458				Gambia/GM	958	958			458					
Cameroon/CM	958	958			458				Georgia/GE	958	958			458					
									Germany*/DE	951	951	451	451	451	681	651			

*UPS Worldwide Express NA1® service is available from this country.

† For shipments from South America to Dade or Broward County, Florida, use zone:
 – 971 for UPS Worldwide Express
 – 471 for UPS Worldwide Express Freight Midday
 – 471 for UPS Worldwide Express Freight
 – 471 for UPS Worldwide Saver
 – 671 for UPS Worldwide Expedited

For shipments from the Caribbean to Dade or Broward County, Florida, use zone:
 – 970 for UPS Worldwide Express
 – 470 for UPS Worldwide Express Freight Midday
 – 470 for UPS Worldwide Express Freight
 – 470 for UPS Worldwide Saver
 – 670 for UPS Worldwide Expedited

Import

Worldwide Zone Chart

Origin	Zones						UPS Worldwide Expedited*	WEST	EAST	Origin	Zones						UPS Worldwide Expedited*	WEST	EAST
	UPS Worldwide Express Plus®	UPS Worldwide Express®	UPS Worldwide Express Freight® Midday	UPS Worldwide Express Freight®	UPS Worldwide Saver®						UPS Worldwide Express Plus®	UPS Worldwide Express®	UPS Worldwide Express Freight® Midday	UPS Worldwide Express Freight®	UPS Worldwide Saver®				
Ghana/GH	958	958			458				Liberia/LR	958	958			458					
Gibraltar/GI	958	958			458				Libya/LY	958	958			458					
Great Britain (United Kingdom)*/GB	951	951	451	451	451	681	651		Liechtenstein/LI	953	953	453	453	453	683	653			
Greece/GR	953	953	453	453	453	683	653		Lithuania/LT	957	957	457	457	457	687	657			
Grenada/GD†	952	952			452				Luxembourg/LU	951	951	451	451	451	681	651			
Guadeloupe/GP†	952	952			452				Macau/MO	954	954			454	684	654			
Guam/GU	958	958			458				Macedonia (FYROM)/MK	958	958			458					
Guatemala/GT†	956	956	456	456	456	686	656		Madagascar/MG	958	958			458					
Guernsey/GG	953	953			453	683	653		Madeira (Portugal)/PT	953	953			453	683	653			
Guinea/GN	958	958			458				Malawi/MW	958	958			458					
Guinea-Bissau/GW	958	958			458				Malaysia/MY	954	954	454	454	454	684	654			
Guyana/GY†	956	956			456				Maldives/MV	958	958			458	688	658			
Haiti/HT†	952	952			452	682	652		Mali/ML	958	958			458					
Holland (Netherlands)/NL	951	951	451	451	451	681	651		Malta/MT	958	958	458	458	458					
Honduras/HN†	956	956	456	456	456	686	656		Martinique/MQ†	952	952			452					
Hong Kong/HK	959	959	459	459	459	689	659		Mauritania/MR	958	958			458					
Hungary/HU	957	957	457	457	457	687	657		Mauritius/MU	958	958		458	458					
Iceland/IS	958	958			458				Mayotte/YT	958	958			458					
India/IN	961	961	461	461	461	691	661		Mexico/MX	94	94	494	494	494	64	64			
Indonesia/ID	954	954	454	454	454	684	654		<i>For UPS® Standard zones, refer to page 45.</i>										
Iraq/IQ	958	958			458	688	658		Moldova/MD	958	958			458					
Ireland, Republic of/IE	951	951	451	451	451	681	651		Monaco/MC	951	951	451	451	451	681	651			
Israel/IL	955	955	455	455	455	685	655		Mongolia/MN	958	958			458					
Italy/IT	951	951	451	451	451	681	651		Montenegro/ME	958	958			458					
Ivory Coast (Côte d'Ivoire)/CI	958	958			458				Montserrat/MS†	952	952			452					
Jamaica/JM†	952	952			452				Morocco/MA	958	958	458	458	458	688	658			
Japan/JP	963	963	463	463	463	693	663		Mozambique/MZ	958	958			458					
Jersey/JE	953	953			453	683	653		Myanmar/MM	961	961			461	691	661			
Jordan/JO	955	955			455				Namibia/NA	958	958			458					
Kazakhstan/KZ	958	958			458	688	658		Nepal/NP	961	961			461					
Kenya/KE	958	958		458	458	688	658		Netherlands (Holland)*/NL	951	951	451	451	451	681	651			
Korea, South/KR	959	959	459	459	459	689	659		Netherlands Antilles/AN†										
Kosovo/KV	958	958			458				<i>Refer to Bonaire, St. Eustatius, Saba, Curaçao, St. Martin or St. Maarten for zone information.</i>										
Kuwait/KW	955	955			455	685	655		New Caledonia/NC	958	958			458					
Kyrgyzstan/KG	958	958			458				New Zealand/NZ	954	954	454	454	454	684	654			
Laos/LA	958	958			458				Nicaragua/NI†	956	956	456	456	456	686	656			
Latvia/LV	957	957	457	457	457	687	657		Niger/NE	958	958			458					
Lesotho/LS	958	958			458				Nigeria/NG	958	958		458	458	688	658			

*UPS Worldwide Express NA1® service is available from this country.

† For shipments from South America to Dade or Broward County, Florida, use zone:
 – 971 for UPS Worldwide Express
 – 471 for UPS Worldwide Express Freight Midday
 – 471 for UPS Worldwide Express Freight
 – 471 for UPS Worldwide Saver
 – 671 for UPS Worldwide Expedited

For shipments from the Caribbean to Dade or Broward County, Florida, use zone:
 – 970 for UPS Worldwide Express
 – 470 for UPS Worldwide Express Freight Midday
 – 470 for UPS Worldwide Express Freight
 – 470 for UPS Worldwide Saver
 – 670 for UPS Worldwide Expedited

Import

Worldwide Zone Chart

Origin	Zones						Origin	Zones							
	UPS Worldwide Express Plus®	UPS Worldwide Express®	UPS Worldwide Express Freight® Middy	UPS Worldwide Express Freight®	UPS Worldwide Saver®	UPS Worldwide Expedited®		WEST	EAST	UPS Worldwide Express Plus®	UPS Worldwide Express®	UPS Worldwide Express Freight® Middy	UPS Worldwide Express Freight®	UPS Worldwide Saver®	UPS Worldwide Expedited®
Northern Ireland (United Kingdom)/GB	951	951	451	451	451	681	651	St. Lucia/LC†	952	952			452	682	652
Northern Mariana Islands/MP	958	958			458			St. Maarten/SX†	952	952			452		
Norway/NO	953	953	453	453	453	683	653	St. Martin/SX†	952	952			452		
Oman/OM	955	955		455	455	685	655	St. Thomas (U.S. Virgin Islands)/VI†	952	952			452		
Pakistan/PK	961	961	461	461	461	691	661	St. Vincent and the Grenadines/VC†	952	952			452		
Panama/PA†	956	956	456	456	456	686	656	Suriname/SR†	956	956			456		
Paraguay/PY†	956	956			456			Swaziland/SZ	958	958			458		
Peru/PE†	956	956			456	686	656	Sweden/SE	953	953	453	453	453	683	653
Philippines/PH	959	959	459	459	459	689	659	Switzerland/CH	953	953	453	453	453	683	653
Poland/PL	957	957	457	457	457	687	657	Taiwan/TW	954	954	454	454	454	684	654
Portugal/PT	953	953	453	453	453	683	653	Tajikistan/TJ	958	958			458		
Qatar/QA	955	955	455	455	455	685	655	Tanzania/TZ	958	958			458		
Réunion/RE	958	958		458	458			Thailand/TH	954	954	454	454	454	684	654
Romania/RO	957	957	457	457	457	687	657	Tinian (Northern Mariana Islands)/MP	958	958			458		
Roata (Northern Mariana Islands)/MP	958	958			458			Togo/TG	958	958			458		
Russia/RU	957	957		457	457	687	657	Tortola (British Virgin Islands)/VG†	952	952			452		
Rwanda/RW	958	958			458			Trinidad and Tobago/TT†	952	952			452		
Saba/BQ†	952	952			452			Tunisia/TN	958	958	458	458	458		
Saipan (Northern Mariana Islands)/MP	958	958			458			Turkey/TR	955	955	455	455	455	685	655
Samoa/WS	958	958			458			Turkmenistan/TM	958	958			458		
San Marino/SM	951	951	451	451	451	681	651	Turks and Caicos Islands/TC†	952	952			452		
Saudi Arabia/SA	955	955	455	455	455	685	655	Uganda/UG	958	958			458		
Scotland (United Kingdom)/GB	951	951	451	451	451	681	651	Ukraine/UA	958	958			458		
Senegal/SN	958	958			458			Union Island (St. Vincent and the Grenadines)/VC†	952	952			452		
Serbia/RS	958	958	458	458	458			United Arab Emirates/AE	955	955	455	455	455	685	655
Seychelles/SC	958	958			458			United Kingdom*/GB	951	951	451	451	451	681	651
Sierra Leone/SL	958	958			458			Uruguay/UY†	956	956			456		
Singapore/SG	954	954	454	454	454	684	654	U.S. Virgin Islands/VI†	952	952			452		
Slovakia/SK	957	957	457	457	457	687	657	Uzbekistan/UZ	958	958			458		
Slovenia/SI	957	957		457	457	687	657	Vatican City (Italy)/VA	951	951	451	451	451	681	651
South Africa/ZA	957	957	457	457	457	687	657	Venezuela/VE†	956	956			456	686	656
Spain/ES	953	953	453	453	453	683	653	Vietnam/VN	954	954	454	454	454	684	654
Sri Lanka/LK	961	961	461	461	461			Virgin Gorda (British Virgin Islands)/VG†	952	952			452		
St. Barthélemy/BL†	952	952			452			Wales (United Kingdom)/GB	951	951	451	451	451	681	651
St. Christopher (St. Kitts and Nevis)/KN†	952	952			452			Zambia/ZM	958	958			458		
St. Croix (U.S. Virgin Islands)/VI†	952	952			452			Zimbabwe/ZW	958	958			458		
St. Eustatius/BQ†	952	952			452										
St. John (U.S. Virgin Islands)/VI†	952	952			452										
St. Kitts and Nevis/KN†	952	952			452	682	652								

*UPS Worldwide Express NA1® service is available from this country.

† For shipments from South America to Dade or Broward County, Florida, use zone:
 – 971 for UPS Worldwide Express
 – 471 for UPS Worldwide Express Freight Middy
 – 471 for UPS Worldwide Express Freight
 – 471 for UPS Worldwide Saver
 – 671 for UPS Worldwide Expedited

For shipments from the Caribbean to Dade or Broward County, Florida, use zone:
 – 970 for UPS Worldwide Express
 – 470 for UPS Worldwide Express Freight Middy
 – 470 for UPS Worldwide Express Freight
 – 470 for UPS Worldwide Saver
 – 670 for UPS Worldwide Expedited

Import

UPS 3 Day Select® and UPS® Standard Zone Chart

SHIPMENTS FROM CANADA

Destination State	Origin Province					
	Alberta British Columbia		Manitoba Saskatchewan		New Brunswick Newfoundland Nova Scotia Ontario Prince Edward Island Quebec	
	3 Day Zone	Standard Zone	3 Day Zone	Standard Zone	3 Day Zone	Standard Zone
Alabama	477	380	477	380	476	378
Alaska	—	—	—	—	—	—
Arizona	476	378	476	378	477	380
Arkansas	477	380	476	378	476	378
California	476	378	477	380	477	380
Colorado	476	378	476	378	477	380
Connecticut	477	380	476	378	475	376
Delaware	477	380	476	378	475	376
District of Columbia	477	380	476	378	475	376
Florida	477	380	477	380	476	378
Georgia	477	380	477	380	476	378
Hawaii	—	—	—	—	—	—
Idaho	475	376	476	378	477	380
Illinois	477	380	476	378	476	378
Indiana	477	380	476	378	476	378
Iowa	477	380	475	376	476	378
Kansas	477	380	476	378	476	378
Kentucky	477	380	476	378	476	378
Louisiana	477	380	477	380	476	378
Maine	477	380	476	378	475	376
Maryland	477	380	476	378	475	376
Massachusetts	477	380	476	378	475	376
Michigan	477	380	476	378	475	376
Minnesota	477	380	475	376	476	378
Mississippi	477	380	477	380	476	378
Missouri	477	380	476	378	476	378
Montana	475	376	475	376	477	380
Nebraska	476	378	475	376	476	378
Nevada	476	378	476	378	477	380
New Hampshire	477	380	476	378	475	376
New Jersey	477	380	476	378	475	376
New Mexico	476	378	476	378	477	380
New York	477	380	476	378	475	376
North Carolina	477	380	477	380	476	378
North Dakota	476	378	475	376	476	378
Ohio	477	380	476	378	475	376
Oklahoma	477	380	476	378	476	378
Oregon	475	376	476	378	477	380
Pennsylvania	477	380	476	378	475	376
Rhode Island	477	380	476	378	475	376
South Carolina	477	380	477	380	476	378
South Dakota	476	378	475	376	476	378
Tennessee	477	380	476	378	476	378
Texas	477	380	477	380	477	380
Utah	476	378	476	378	477	380
Vermont	477	380	476	378	475	376
Virginia	477	380	476	378	476	378
Washington	475	376	476	378	477	380
West Virginia	477	380	476	378	475	376
Wisconsin	477	380	475	376	476	378
Wyoming	476	378	475	376	477	380

Import

UPS® Standard Zone Chart

SHIPMENTS FROM MEXICO

Destination ZIP Code	Standard Zone
00400-00599	367
01000-03999	367
04000-04999	368
05000-08999	367
10000-14699	367
14700-14799	366
14800-14999	367
15000-16899	366
16900-17299	367
17300-17499	366
17500-19999	367
20000-21799	366
21800-21999	367
22000-28699	366
28700-28999	365
29000-29599	366
29600-29699	365
29700-29799	366
29800-29899	365
29900-29999	366
30000-31299	365
31300-31499	366
31500-32699	365
32700-33499	366
33500-33899	365
33900-33999	366
34100-34199	366
34200-34699	365
34700-34999	366
35000-36499	365
36500-36699	364
36700-36899	365
36900-36999	364
37000-37599	365
37600-37699	366
37700-38699	365
38700-38799	364
38800-38899	365
38900-39699	364
39700-40999	365
41000-41299	366

Destination ZIP Code	Standard Zone
41300-41499	365
41500-41899	366
42000-42799	365
43000-45999	366
46000-46299	365
46300-46899	366
46900-46999	365
47000-47099	366
47100-47299	365
47300-47399	366
47400-47999	365
48000-49999	366
50000-52099	365
52100-52199	366
52200-52899	365
53000-53799	366
53800-53899	365
53900-56099	366
56100-56199	365
56200-56799	366
57000-57199	365
57200-57299	366
57300-57399	365
57400-59399	366
59400-59699	367
59700-59799	366
59800-59999	367
60000-60899	366
60900-60999	365
61000-61199	366
61200-64799	365
64800-64899	364
64900-65599	365
65600-65999	364
66000-66699	365
66700-66799	364
66800-66999	365
67000-67399	364
67400-67799	365
67800-67999	364
68000-69399	365

Destination ZIP Code	Standard Zone
70000-70599	364
70600-70699	363
70700-72299	364
72300-72499	365
72500-73299	364
73300-73399	362
73400-74999	364
75000-75499	363
75500-75599	364
75600-76499	363
76500-76599	362
76600-77799	363
77800-78499	362
78500-78599	363
78600-78999	362
79000-79499	364
79500-79799	363
79800-79999	364
80000-82099	365
82100-82199	366
82200-82399	365
82400-83499	366
83500-83599	367
83600-83799	366
83800-83899	367
84000-84499	366
84500-84599	365
84600-84799	366
85000-86399	365
86400-86499	366
86500-87599	365
87700-88599	364
88900-93899	366
93900-96099	367
96100-96199	366
97000-97899	367
97900-97999	366
98000-98699	367
98800-99499	367

Domestic

UPS Next Day Air[®] Early

Guaranteed on-time, overnight delivery on business days by 8:00 a.m. to major cities in the 48 contiguous states and by 8:30 a.m., 9:00 a.m. or 9:30 a.m. to most other cities in the U.S., including Anchorage, Alaska. Additional extended delivery locations are guaranteed up to 2:00 p.m. Optional Saturday Delivery and pickup available in select locations.

Zones	102	103	104	105	106	107	108	124*
Letter**	\$62.97	\$69.78	\$80.11	\$83.65	\$84.73	\$90.78	\$93.54	\$104.22
1 Lbs.	70.40	89.51	106.99	115.14	119.64	131.81	134.58	143.55
2	70.93	89.87	114.09	121.41	124.14	136.00	146.86	154.63
3	74.64	96.40	123.13	134.48	142.34	153.35	157.73	164.30
4	78.69	97.82	134.16	144.40	148.56	163.98	169.02	182.08
5	79.09	98.21	136.34	145.43	149.65	165.69	169.61	194.59
6	86.29	105.28	149.59	164.99	171.21	185.79	192.49	206.51
7	87.03	109.20	154.93	171.64	177.01	192.60	203.60	218.18
8	87.26	109.60	159.69	177.13	183.93	202.22	208.99	229.56
9	87.52	110.17	165.01	177.69	184.63	203.19	209.57	242.48
10	88.04	111.19	166.51	178.99	186.78	204.86	211.12	254.91
11	98.17	125.59	196.46	219.04	228.72	238.29	242.47	269.46
12	99.78	128.76	200.21	227.95	237.79	242.65	246.93	281.14
13	100.04	129.73	203.54	234.39	238.67	261.53	266.20	293.67
14	101.45	130.96	211.14	234.84	238.95	263.41	268.10	294.93
15	101.73	131.56	213.77	236.13	240.26	264.62	269.34	313.97
16	106.35	143.70	227.25	260.38	266.38	288.36	293.53	325.23
17	110.60	144.92	238.27	263.74	269.11	290.74	295.98	331.79
18	111.24	145.56	239.52	263.99	269.39	290.99	296.21	339.23
19	111.76	145.79	239.75	264.15	269.61	291.23	296.47	349.52
20	112.17	146.31	239.82	265.39	270.35	291.99	296.74	355.80
21	115.81	151.62	258.33	272.28	285.04	306.43	322.93	363.30
22	119.72	158.36	265.18	281.54	286.84	320.65	334.08	370.78
23	120.23	159.04	272.17	292.65	307.55	336.54	342.71	380.03
24	122.61	159.60	275.64	303.26	309.63	342.33	349.00	386.64
25	123.09	160.12	284.05	304.33	315.08	343.61	349.82	397.88
26	128.78	170.44	298.76	323.26	337.69	351.40	365.74	403.45
27	129.17	171.49	304.90	324.61	344.35	359.24	380.77	411.22
28	131.24	171.98	312.28	333.26	345.61	366.57	389.48	418.34
29	131.76	172.69	318.72	334.14	346.28	375.11	391.36	424.52
30	132.20	172.97	319.37	336.81	347.34	376.64	391.43	431.68
31	136.32	176.99	331.65	350.50	373.64	389.62	405.45	438.91
32	139.13	180.50	338.05	352.41	377.04	391.39	409.59	446.67
33	141.77	188.99	343.67	371.80	383.67	411.39	426.14	456.06
34	144.17	189.84	349.73	375.59	384.29	420.69	428.52	461.97
35	146.60	190.32	350.98	375.96	384.92	424.34	432.25	462.95

*Zone 124 includes metro Alaska.

**The Letter rate applies only to documents, correspondence and electronic media shipments that do not exceed eight ounces sent in a UPS Express[®] Envelope.

Note: For additional information, refer to page [28](#).

Domestic UPS Next Day Air[®] Early

Zones	102	103	104	105	106	107	108	124*
36 Lbs.	\$151.44	\$193.45	\$363.08	\$382.94	\$397.34	\$429.24	\$440.78	\$482.17
37	152.27	204.40	371.48	404.85	415.13	443.30	454.73	491.89
38	152.68	205.52	376.19	406.27	421.41	444.63	456.13	500.41
39	153.15	205.98	382.20	406.50	422.04	455.08	463.70	509.63
40	153.48	206.45	382.79	407.69	423.16	456.13	464.65	519.25
41	158.93	214.84	395.05	418.55	444.89	462.16	483.51	528.89
42	160.81	215.66	399.71	424.49	447.06	463.77	492.03	539.00
43	164.34	218.66	409.19	435.05	454.69	483.45	517.71	549.27
44	167.36	228.54	415.50	444.08	462.09	490.81	520.46	560.52
45	173.02	236.26	420.43	450.30	462.85	499.80	521.24	568.90
46	176.41	237.05	426.78	459.60	476.70	505.15	540.50	578.29
47	178.52	240.07	427.49	461.27	479.71	506.55	543.20	587.13
48	180.19	240.49	428.42	466.13	480.16	515.22	543.87	597.56
49	180.26	240.75	428.52	466.25	480.41	515.48	544.14	600.74
50	180.33	241.93	428.85	466.80	482.20	516.53	545.63	607.48
51	196.68	263.16	455.34	503.42	513.05	552.65	569.90	630.69
52	199.26	275.37	485.75	512.69	530.74	573.07	599.66	662.37
53	201.06	276.61	488.80	523.42	532.50	599.18	611.40	665.53
54	201.58	277.12	489.29	528.06	533.02	601.78	612.59	682.62
55	202.21	281.41	492.62	529.28	534.26	601.84	613.09	689.21
56	214.70	295.49	493.12	537.94	548.11	601.90	613.56	691.95
57	216.28	298.16	493.98	539.30	550.48	602.58	614.04	698.47
58	216.82	299.28	494.54	539.79	561.12	604.13	615.62	722.37
59	217.34	299.82	505.59	547.46	562.21	606.71	646.67	724.75
60	217.88	300.34	506.70	548.24	563.29	643.62	649.78	741.26
61	227.68	309.87	525.87	563.25	584.89	656.61	669.16	753.52
62	229.94	318.54	533.42	569.86	587.16	665.57	684.54	754.78
63	230.52	319.44	537.95	570.63	589.73	674.62	687.52	755.76
64	240.56	328.60	538.44	585.80	607.06	686.28	711.86	775.14
65	241.58	330.61	542.81	591.87	610.69	696.44	719.53	777.08
66	242.13	331.45	564.16	609.36	628.48	697.47	720.95	778.24
67	244.15	347.86	566.29	615.05	630.26	697.96	721.43	801.14
68	248.99	349.70	566.79	622.63	630.79	698.44	725.44	803.45
69	249.50	350.23	567.34	624.21	631.77	698.93	738.72	805.11
70	250.04	350.76	567.83	626.32	632.28	700.35	740.06	830.51
71	256.32	351.28	569.58	627.40	633.40	728.65	742.64	849.43
72	257.76	360.73	604.35	647.45	653.62	759.06	794.01	857.29
73	258.30	367.63	607.83	649.45	655.65	762.11	799.16	858.98
74	258.84	368.33	608.38	649.96	656.16	762.59	799.72	892.50
75	259.92	369.40	609.35	650.98	657.17	763.58	800.69	895.85

*Zone 124 includes metro Alaska.

Note: For additional information, refer to page 28.

Domestic

UPS Next Day Air® Early

Zones	102	103	104	105	106	107	108	124*
76 Lbs.	\$271.77	\$378.83	\$612.46	\$656.27	\$662.53	\$782.94	\$801.67	\$904.50
77	272.98	390.50	614.83	676.32	688.13	784.89	802.64	909.64
78	274.03	391.68	636.28	684.96	705.31	793.34	803.60	917.51
79	275.09	392.72	638.44	694.73	715.30	806.43	814.22	963.28
80	276.17	393.80	639.42	696.85	717.24	809.67	817.49	968.39
81	287.19	398.53	657.47	737.68	753.69	829.34	838.26	969.60
82	288.29	399.60	660.79	741.77	757.34	831.31	840.32	970.67
83	289.39	400.67	661.80	742.78	758.35	832.35	841.37	971.73
84	290.44	401.74	662.83	743.79	759.38	848.65	858.39	972.70
85	291.52	402.82	663.85	744.80	760.36	848.72	860.26	983.26
86	294.80	405.18	665.66	753.83	761.73	851.38	861.31	984.70
87	295.59	405.59	688.47	757.48	765.01	852.64	862.61	1,013.19
88	296.39	406.39	690.76	758.48	766.88	855.77	866.81	1,033.30
89	297.19	407.19	717.98	783.41	804.29	912.70	950.89	1,035.31
90	298.00	407.99	721.98	787.82	813.97	950.06	968.34	1,037.46
91	298.80	408.80	722.80	788.80	814.97	953.81	970.07	1,038.41
92	299.60	409.60	723.60	789.77	816.38	954.86	971.22	1,039.37
93	300.40	410.40	724.40	790.74	817.37	955.86	972.33	1,040.33
94	301.20	411.20	725.20	791.71	818.37	957.25	973.47	1,041.30
95	302.00	412.00	726.00	797.18	819.41	958.28	974.60	1,042.27
96	302.80	416.67	726.80	802.31	825.45	961.24	975.59	1,043.21
97	303.95	417.48	727.60	808.67	833.66	962.27	976.85	1,045.26
98	304.63	418.27	728.40	811.03	849.57	964.48	979.12	1,086.04
99	306.82	419.08	729.20	850.07	869.67	1,008.83	1,024.24	1,126.62
100	308.57	419.86	737.00	862.24	879.41	1,060.28	1,128.00	1,245.72
101	311.35	423.80	744.11	870.59	887.93	1,070.30	1,138.98	1,257.90
102	314.13	427.70	751.17	878.92	896.43	1,080.60	1,149.96	1,270.05
103	316.92	431.59	758.24	887.23	904.91	1,090.90	1,160.94	1,282.21
104	319.70	435.48	765.30	895.55	913.43	1,101.20	1,171.92	1,294.37
105	322.73	439.37	772.37	903.89	921.91	1,111.50	1,182.90	1,306.53
106	325.25	443.28	779.44	912.20	930.39	1,121.80	1,193.88	1,318.69
107	328.04	447.18	786.52	920.52	938.90	1,132.10	1,204.86	1,330.83
108	330.82	451.08	793.59	928.85	947.39	1,142.40	1,215.84	1,343.00
109	333.60	454.97	800.66	937.17	955.88	1,152.70	1,226.82	1,355.16
110	336.43	458.87	807.73	945.50	964.39	1,163.00	1,237.80	1,367.31
111	339.22	462.76	814.78	953.82	972.87	1,173.30	1,248.78	1,379.48
112	342.00	466.67	821.86	962.13	981.36	1,183.60	1,259.76	1,391.63
113	344.17	470.56	828.95	970.47	989.87	1,193.90	1,270.74	1,401.76
114	347.56	474.48	836.01	978.79	998.36	1,204.20	1,281.72	1,413.91
115	350.35	478.38	843.07	987.10	1,006.85	1,214.50	1,292.70	1,428.10

*Zone 124 includes metro Alaska.

Note: For additional information, refer to page 28.

Domestic

UPS Next Day Air® Early

Zones	102	103	104	105	106	107	108	124*
116 Lbs.	\$353.12	\$482.27	\$850.15	\$995.43	\$1,015.34	\$1,224.80	\$1,303.68	\$1,440.26
117	355.90	486.16	857.22	1,003.75	1,023.84	1,235.10	1,314.66	1,452.41
118	358.07	490.07	864.28	1,012.08	1,032.33	1,245.40	1,325.64	1,464.57
119	361.49	493.96	871.36	1,020.39	1,040.82	1,255.70	1,336.62	1,474.59
120	364.27	497.85	878.43	1,028.73	1,049.33	1,266.00	1,347.60	1,488.88
121	367.06	501.74	885.50	1,037.04	1,057.80	1,276.30	1,358.58	1,501.03
122	369.84	505.65	892.56	1,045.37	1,066.32	1,286.60	1,369.56	1,513.20
123	372.63	509.57	899.64	1,053.69	1,074.80	1,296.90	1,380.54	1,525.36
124	375.41	513.46	906.71	1,062.00	1,083.30	1,307.20	1,391.52	1,535.30
125	378.19	517.36	913.79	1,070.31	1,091.79	1,317.50	1,402.50	1,547.44
126	380.97	521.25	920.85	1,078.66	1,100.29	1,327.80	1,413.48	1,559.57
127	383.09	525.14	927.92	1,086.97	1,108.78	1,338.10	1,424.46	1,571.71
128	385.87	529.03	934.98	1,095.29	1,117.26	1,348.40	1,435.44	1,583.84
129	389.33	532.96	942.05	1,103.62	1,125.79	1,358.70	1,446.42	1,595.97
130	392.11	536.85	949.13	1,111.95	1,134.26	1,369.00	1,457.40	1,608.12
131	394.20	540.75	956.20	1,120.26	1,142.74	1,379.30	1,468.38	1,620.25
132	396.98	544.64	963.28	1,128.59	1,151.25	1,389.60	1,479.36	1,632.38
133	399.76	548.54	970.33	1,136.90	1,159.74	1,399.90	1,490.34	1,644.55
134	402.53	552.44	977.40	1,145.23	1,168.23	1,410.20	1,501.32	1,656.70
135	406.05	556.35	984.47	1,153.56	1,176.73	1,420.50	1,512.30	1,668.82
136	408.09	560.24	991.55	1,161.88	1,185.22	1,430.80	1,523.28	1,680.98
137	410.87	564.14	998.61	1,170.18	1,193.72	1,441.10	1,534.26	1,693.11
138	414.40	568.03	1,005.69	1,178.54	1,202.21	1,451.40	1,545.24	1,705.25
139	416.46	571.93	1,012.77	1,186.84	1,210.73	1,461.70	1,556.22	1,717.37
140	419.25	575.82	1,019.82	1,195.17	1,219.20	1,472.00	1,567.20	1,729.51
141	422.76	579.73	1,026.88	1,203.49	1,227.68	1,482.30	1,578.18	1,741.67
142	425.54	583.62	1,033.98	1,211.82	1,236.20	1,492.60	1,589.16	1,753.81
143	427.57	587.53	1,041.04	1,220.13	1,244.68	1,502.90	1,600.14	1,765.94
144	430.36	591.42	1,048.11	1,228.46	1,253.19	1,513.20	1,611.12	1,778.08
145	433.13	595.33	1,055.18	1,236.78	1,261.67	1,523.50	1,622.10	1,790.22
146	435.91	599.23	1,062.26	1,245.10	1,270.16	1,533.80	1,633.08	1,802.35
147	438.68	603.13	1,069.31	1,253.43	1,278.67	1,544.10	1,644.06	1,814.51
148	441.47	607.02	1,076.38	1,261.75	1,287.15	1,554.40	1,655.04	1,826.63
149	445.04	610.92	1,083.45	1,270.06	1,295.66	1,564.70	1,666.02	1,838.78
150	447.82	614.82	1,090.53	1,278.41	1,304.15	1,575.00	1,677.00	1,850.92
More Than 150 Pounds**								
Price Per Pound	\$2.79	\$3.90	\$7.07	\$8.32	\$8.49	\$10.30	\$10.98	\$12.14

*Zone 124 includes metro Alaska.

**For each UPS Next Day Air Early package with a weight of more than 150 pounds, multiply the weight by the price per pound and add \$30.00.

Note: For additional information, refer to page [28](#).

Domestic

UPS Next Day Air[®]

Guaranteed on-time delivery to all 50 states and Puerto Rico by 10:30 a.m., 12:00 p.m. or end of next business day to commercial destinations. Shipments to residential destinations are delivered by 12:00 p.m. or end of next business day. Some limitations apply to Alaska and Hawaii. Optional Saturday Delivery and pickup available.

Zones	102	103	104	105	106	107	108	124*	125*	126*
Letter**	\$32.97	\$39.78	\$50.11	\$53.65	\$54.73	\$60.78	\$63.54	\$74.22	\$53.95	\$80.93
1 Lbs.	40.40	59.51	76.99	85.14	89.64	101.81	104.58	113.55	87.08	113.63
2	40.93	59.87	84.09	91.41	94.14	106.00	116.86	124.63	95.07	124.75
3	44.64	66.40	93.13	104.48	112.34	123.35	127.73	134.30	105.98	154.03
4	48.69	67.82	104.16	114.40	118.56	133.98	139.02	152.08	115.72	172.96
5	49.09	68.21	106.34	115.43	119.65	135.69	139.61	164.59	125.38	185.35
6	56.29	75.28	119.59	134.99	141.21	155.79	162.49	176.51	134.35	198.35
7	57.03	79.20	124.93	141.64	147.01	162.60	173.60	188.18	144.01	211.35
8	57.26	79.60	129.69	147.13	153.93	172.22	178.99	199.56	151.83	221.27
9	57.52	80.17	135.01	147.69	154.63	173.19	179.57	212.48	161.58	233.38
10	58.04	81.19	136.51	148.99	156.78	174.86	181.12	224.91	171.98	234.94
11	68.17	95.59	166.46	189.04	198.72	208.29	212.47	239.46	181.68	265.82
12	69.78	98.76	170.21	197.95	207.79	212.65	216.93	251.14	190.52	271.63
13	70.04	99.73	173.54	204.39	208.67	231.53	236.20	263.67	198.98	279.01
14	71.45	100.96	181.14	204.84	208.95	233.41	238.10	264.93	208.04	279.76
15	71.73	101.56	183.77	206.13	210.26	234.62	239.34	283.97	215.35	293.52
16	76.35	113.70	197.25	230.38	236.38	258.36	263.53	295.23	223.85	305.95
17	80.60	114.92	208.27	233.74	239.11	260.74	265.98	301.79	228.79	314.37
18	81.24	115.56	209.52	233.99	239.39	260.99	266.21	309.23	234.60	326.51
19	81.76	115.79	209.75	234.15	239.61	261.23	266.47	319.52	242.43	335.03
20	82.17	116.31	209.82	235.39	240.35	261.99	266.74	325.80	247.17	356.32
21	85.81	121.62	228.33	242.28	255.04	276.43	292.93	333.30	252.83	365.73
22	89.72	128.36	235.18	251.54	256.84	290.65	304.08	340.78	258.47	373.83
23	90.23	129.04	242.17	262.65	277.55	306.54	312.71	350.03	265.57	379.91
24	92.61	129.60	245.64	273.26	279.63	312.33	319.00	356.64	270.61	386.93
25	93.09	130.12	254.05	274.33	285.08	313.61	319.82	367.88	279.09	389.19
26	98.78	140.44	268.76	293.26	307.69	321.40	335.74	373.45	283.28	401.16
27	99.17	141.49	274.90	294.61	314.35	329.24	350.77	381.22	289.29	407.70
28	101.24	141.98	282.28	303.26	315.61	336.57	359.48	388.34	294.69	416.12
29	101.76	142.69	288.72	304.14	316.28	345.11	361.36	394.52	299.23	425.25
30	102.20	142.97	289.37	306.81	317.34	346.64	361.43	401.68	304.63	426.85
31	106.32	146.99	301.65	320.50	343.64	359.62	375.45	408.91	310.15	440.40
32	109.13	150.50	308.05	322.41	347.04	361.39	379.59	416.67	315.95	449.56
33	111.77	158.99	313.67	341.80	353.67	381.39	396.14	426.06	323.18	458.94
34	114.17	159.84	319.73	345.59	354.29	390.69	398.52	431.97	329.69	467.42
35	116.60	160.32	320.98	345.96	354.92	394.34	402.25	432.95	336.46	476.37

*Zone 124 is metro Alaska and Hawaii, Zone 125 is Puerto Rico, and Zone 126 is remote Alaska and Hawaii. Zone 126 for remote Hawaii is not delivered the next business day. Delivery to this zone requires an additional day.

**The Letter rate applies only to documents, correspondence and electronic media shipments that do not exceed eight ounces and are sent in a UPS Express[®] Envelope.

Note: For additional information, refer to page [28](#).

Domestic

UPS Next Day Air®

Zones	102	103	104	105	106	107	108	124*	125*	126*
36 Lbs.	\$121.44	\$163.45	\$333.08	\$352.94	\$367.34	\$399.24	\$410.78	\$452.17	\$342.96	\$486.67
37	122.27	174.40	341.48	374.85	385.13	413.30	424.73	461.89	350.40	494.33
38	122.68	175.52	346.19	376.27	391.41	414.63	426.13	470.41	356.86	501.91
39	123.15	175.98	352.20	376.50	392.04	425.08	433.70	479.63	363.83	502.70
40	123.48	176.45	352.79	377.69	393.16	426.13	434.65	489.25	371.15	504.06
41	128.93	184.84	365.05	388.55	414.89	432.16	453.51	498.89	378.42	531.11
42	130.81	185.66	369.71	394.49	417.06	433.77	462.03	509.00	386.16	533.80
43	134.34	188.66	379.19	405.05	424.69	453.45	487.71	519.27	393.98	535.00
44	137.36	198.54	385.50	414.08	432.09	460.81	490.46	530.52	402.45	558.72
45	143.02	206.26	390.43	420.30	432.85	469.80	491.24	538.90	408.94	561.49
46	146.41	207.05	396.78	429.60	446.70	475.15	510.50	548.29	415.99	577.15
47	148.52	210.07	397.49	431.27	449.71	476.55	513.20	557.13	422.50	578.72
48	150.19	210.49	398.42	436.13	450.16	485.22	513.87	567.56	430.39	579.18
49	150.26	210.75	398.52	436.25	450.41	485.48	514.14	570.74	438.12	582.17
50	150.33	211.93	398.85	436.80	452.20	486.53	515.63	577.48	438.27	589.04
51	166.68	233.16	425.34	473.42	483.05	522.65	539.90	600.69	454.78	625.14
52	169.26	245.37	455.75	482.69	500.74	543.07	569.66	632.37	463.97	645.01
53	171.06	246.61	458.80	493.42	502.50	569.18	581.40	635.53	471.75	648.27
54	171.58	247.12	459.29	498.06	503.02	571.78	582.59	652.62	480.59	665.68
55	172.21	251.41	462.62	499.28	504.26	571.84	583.09	659.21	488.05	672.40
56	184.70	265.49	463.12	507.94	518.11	571.90	583.56	661.95	495.83	675.20
57	186.28	268.16	463.98	509.30	520.48	572.58	584.04	668.47	504.02	681.85
58	186.82	269.28	464.54	509.79	531.12	574.13	585.62	692.37	512.85	706.22
59	187.34	269.82	475.59	517.46	532.21	576.71	616.67	694.75	515.02	708.67
60	187.88	270.34	476.70	518.24	533.29	613.62	619.78	711.26	528.20	725.50
61	197.68	279.87	495.87	533.25	554.89	626.61	639.16	723.52	539.92	738.00
62	199.94	288.54	503.42	539.86	557.16	635.57	654.54	724.78	548.43	739.27
63	200.52	289.44	507.95	540.63	559.73	644.62	657.52	725.76	557.29	740.27
64	210.56	298.60	508.44	555.80	577.06	656.28	681.86	745.14	566.23	760.02
65	211.58	300.61	512.81	561.87	580.69	666.44	689.53	747.08	566.43	762.03
66	212.13	301.45	534.16	579.36	598.48	667.47	690.95	748.24	576.49	791.62
67	214.15	317.86	536.29	585.05	600.26	667.96	691.43	771.14	594.21	794.61
68	218.99	319.70	536.79	592.63	600.79	668.44	695.44	773.45	595.73	795.09
69	219.50	320.23	537.34	594.21	601.77	668.93	708.72	775.11	614.21	800.12
70	220.04	320.76	537.83	596.32	602.28	670.35	710.06	800.51	622.44	817.41
71	226.32	321.28	539.58	597.40	603.40	698.65	712.64	819.43	633.86	836.05
72	227.76	330.73	574.35	617.45	623.62	729.06	764.01	827.29	634.01	843.85
73	228.30	337.63	577.83	619.45	625.65	732.11	769.16	828.98	644.77	845.59
74	228.84	338.33	578.38	619.96	626.16	732.59	769.72	862.50	645.18	879.74
75	229.92	339.40	579.35	620.98	627.17	733.58	770.69	865.85	645.28	883.17

*Zone 124 is metro Alaska and Hawaii, Zone 125 is Puerto Rico, and Zone 126 is remote Alaska and Hawaii. Zone 126 for remote Hawaii is not delivered the next business day. Delivery to this zone requires an additional day.

Note: For additional information, refer to page 28.

Domestic

UPS Next Day Air®

Zones	102	103	104	105	106	107	108	124*	125*	126*
76 Lbs.	\$241.77	\$348.83	\$582.46	\$626.27	\$632.53	\$752.94	\$771.67	\$874.50	\$671.87	\$891.98
77	242.98	360.50	584.83	646.32	658.13	754.89	772.64	879.64	687.02	914.69
78	244.03	361.68	606.28	654.96	675.31	763.34	773.60	887.51	696.08	952.42
79	245.09	362.72	608.44	664.73	685.30	776.43	784.22	933.28	698.19	956.19
80	246.17	363.80	609.42	666.85	687.24	779.67	787.49	938.39	714.05	957.15
81	257.19	368.53	627.47	707.68	723.69	799.34	808.26	939.60	714.19	958.39
82	258.29	369.60	630.79	711.77	727.34	801.31	810.32	940.67	726.17	959.49
83	259.39	370.67	631.80	712.78	728.35	802.35	811.37	941.73	726.37	960.59
84	260.44	371.74	632.83	713.79	729.38	818.65	828.39	942.70	733.47	962.10
85	261.52	372.82	633.85	714.80	730.36	818.72	830.26	953.26	733.68	991.96
86	264.80	375.18	635.66	723.83	731.73	821.38	831.31	954.70	733.83	999.22
87	265.59	375.59	658.47	727.48	735.01	822.64	832.61	983.19	767.28	1,002.88
88	266.39	376.39	660.76	728.48	736.88	825.77	836.81	1,003.30	767.38	1,023.35
89	267.19	377.19	687.98	753.41	774.29	882.70	920.89	1,005.31	791.86	1,025.44
90	268.00	377.99	691.98	757.82	783.97	920.06	938.34	1,007.46	792.01	1,027.62
91	268.80	378.80	692.80	758.80	784.97	923.81	940.07	1,008.41	812.32	1,028.60
92	269.60	379.60	693.60	759.77	786.38	924.86	941.22	1,009.37	821.16	1,036.86
93	270.40	380.40	694.40	760.74	787.37	925.86	942.33	1,010.33	821.56	1,040.27
94	271.20	381.20	695.20	761.71	788.37	927.25	943.47	1,011.30	821.61	1,040.71
95	272.00	382.00	696.00	767.18	789.41	928.28	944.60	1,012.27	824.33	1,041.49
96	272.80	386.67	696.80	772.31	795.45	931.24	945.59	1,013.21	827.31	1,095.96
97	273.95	387.48	697.60	778.67	803.66	932.27	946.85	1,015.26	846.61	1,101.54
98	274.63	388.27	698.40	781.03	819.57	934.48	949.12	1,056.04	846.71	1,102.73
99	276.82	389.08	699.20	820.07	839.67	978.83	994.24	1,096.62	858.27	1,118.58
100	278.57	389.86	707.00	832.24	849.41	1,030.28	1,098.00	1,215.72	934.25	1,241.46
101	281.35	393.80	714.11	840.59	857.93	1,040.30	1,108.98	1,227.90	943.61	1,253.90
102	284.13	397.70	721.17	848.92	866.43	1,050.60	1,119.96	1,240.05	952.97	1,266.31
103	286.92	401.59	728.24	857.23	874.91	1,060.90	1,130.94	1,252.21	962.31	1,278.72
104	289.70	405.48	735.30	865.55	883.43	1,071.20	1,141.92	1,264.37	971.65	1,291.14
105	292.73	409.37	742.37	873.89	891.91	1,081.50	1,152.90	1,276.53	980.99	1,303.56
106	295.25	413.28	749.44	882.20	900.39	1,091.80	1,163.88	1,288.69	990.35	1,315.97
107	298.04	417.18	756.52	890.52	908.90	1,102.10	1,174.86	1,300.83	999.67	1,328.38
108	300.82	421.08	763.59	898.85	917.39	1,112.40	1,185.84	1,313.00	1,009.02	1,340.81
109	303.60	424.97	770.66	907.17	925.88	1,122.70	1,196.82	1,325.16	1,018.35	1,353.21
110	306.43	428.87	777.73	915.50	934.39	1,133.00	1,207.80	1,337.31	1,027.71	1,365.63
111	309.22	432.76	784.78	923.82	942.87	1,143.30	1,218.78	1,349.48	1,037.05	1,378.05
112	312.00	436.67	791.86	932.13	951.36	1,153.60	1,229.76	1,361.63	1,046.39	1,390.46
113	314.17	440.56	798.95	940.47	959.87	1,163.90	1,240.74	1,371.76	1,055.72	1,402.87
114	317.56	444.48	806.01	948.79	968.36	1,174.20	1,251.72	1,383.91	1,065.09	1,415.28
115	320.35	448.38	813.07	957.10	976.85	1,184.50	1,262.70	1,398.10	1,074.40	1,427.70

*Zone 124 is metro Alaska and Hawaii, Zone 125 is Puerto Rico, and Zone 126 is remote Alaska and Hawaii. Zone 126 for remote Hawaii is not delivered the next business day. Delivery to this zone requires an additional day.

Note: For additional information, refer to page 28.

Domestic

UPS Next Day Air®

Zones	102	103	104	105	106	107	108	124*	125*	126*
116 Lbs.	\$323.12	\$452.27	\$820.15	\$965.43	\$985.34	\$1,194.80	\$1,273.68	\$1,410.26	\$1,083.76	\$1,440.12
117	325.90	456.16	827.22	973.75	993.84	1,205.10	1,284.66	1,422.41	1,093.09	1,452.53
118	328.07	460.07	834.28	982.08	1,002.33	1,215.40	1,295.64	1,434.57	1,102.44	1,464.94
119	331.49	463.96	841.36	990.39	1,010.82	1,225.70	1,306.62	1,444.59	1,111.79	1,477.36
120	334.27	467.85	848.43	998.73	1,019.33	1,236.00	1,317.60	1,458.88	1,121.12	1,489.78
121	337.06	471.74	855.50	1,007.04	1,027.80	1,246.30	1,328.58	1,471.03	1,130.46	1,502.19
122	339.84	475.65	862.56	1,015.37	1,036.32	1,256.60	1,339.56	1,483.20	1,139.82	1,514.61
123	342.63	479.57	869.64	1,023.69	1,044.80	1,266.90	1,350.54	1,495.36	1,149.15	1,527.01
124	345.41	483.46	876.71	1,032.00	1,053.30	1,277.20	1,361.52	1,505.30	1,158.50	1,539.43
125	348.19	487.36	883.79	1,040.31	1,061.79	1,287.50	1,372.50	1,517.44	1,167.85	1,551.85
126	350.97	491.25	890.85	1,048.66	1,070.29	1,297.80	1,383.48	1,529.57	1,177.18	1,564.26
127	353.09	495.14	897.92	1,056.97	1,078.78	1,308.10	1,394.46	1,541.71	1,186.51	1,576.68
128	355.87	499.03	904.98	1,065.29	1,087.26	1,318.40	1,405.44	1,553.84	1,195.88	1,589.09
129	359.33	502.96	912.05	1,073.62	1,095.79	1,328.70	1,416.42	1,565.97	1,205.19	1,601.50
130	362.11	506.85	919.13	1,081.95	1,104.26	1,339.00	1,427.40	1,578.12	1,214.56	1,613.93
131	364.20	510.75	926.20	1,090.26	1,112.74	1,349.30	1,438.38	1,590.25	1,223.88	1,626.33
132	366.98	514.64	933.28	1,098.59	1,121.25	1,359.60	1,449.36	1,602.38	1,233.23	1,638.75
133	369.76	518.54	940.33	1,106.90	1,129.74	1,369.90	1,460.34	1,614.55	1,242.58	1,651.17
134	372.53	522.44	947.40	1,115.23	1,138.23	1,380.20	1,471.32	1,626.70	1,251.91	1,663.57
135	376.05	526.35	954.47	1,123.56	1,146.73	1,390.50	1,482.30	1,638.82	1,261.25	1,675.99
136	378.09	530.24	961.55	1,131.88	1,155.22	1,400.80	1,493.28	1,650.98	1,270.61	1,688.42
137	380.87	534.14	968.61	1,140.18	1,163.72	1,411.10	1,504.26	1,663.11	1,279.94	1,700.82
138	384.40	538.03	975.69	1,148.54	1,172.21	1,421.40	1,515.24	1,675.25	1,289.30	1,713.24
139	386.46	541.93	982.77	1,156.84	1,180.73	1,431.70	1,526.22	1,687.37	1,298.64	1,725.64
140	389.25	545.82	989.82	1,165.17	1,189.20	1,442.00	1,537.20	1,699.51	1,307.97	1,738.07
141	392.76	549.73	996.88	1,173.49	1,197.68	1,452.30	1,548.18	1,711.67	1,317.34	1,750.49
142	395.54	553.62	1,003.98	1,181.82	1,206.20	1,462.60	1,559.16	1,723.81	1,326.67	1,762.89
143	397.57	557.53	1,011.04	1,190.13	1,214.68	1,472.90	1,570.14	1,735.94	1,335.98	1,775.30
144	400.36	561.42	1,018.11	1,198.46	1,223.19	1,483.20	1,581.12	1,748.08	1,345.35	1,787.73
145	403.13	565.33	1,025.18	1,206.78	1,231.67	1,493.50	1,592.10	1,760.22	1,354.67	1,800.14
146	405.91	569.23	1,032.26	1,215.10	1,240.16	1,503.80	1,603.08	1,772.35	1,364.04	1,812.56
147	408.68	573.13	1,039.31	1,223.43	1,248.67	1,514.10	1,614.06	1,784.51	1,373.39	1,824.97
148	411.47	577.02	1,046.38	1,231.75	1,257.15	1,524.40	1,625.04	1,796.63	1,382.71	1,837.38
149	415.04	580.92	1,053.45	1,240.06	1,265.66	1,534.70	1,636.02	1,808.78	1,392.07	1,849.80
150	417.82	584.82	1,060.53	1,248.41	1,274.15	1,545.00	1,647.00	1,820.92	1,401.41	1,862.21
More Than 150 Pounds**										
Price Per Pound	\$2.79	\$3.90	\$7.07	\$8.32	\$8.49	\$10.30	\$10.98	\$12.14	\$9.34	\$12.41

*Zone 124 is metro Alaska and Hawaii, Zone 125 is Puerto Rico, and Zone 126 is remote Alaska and Hawaii. Zone 126 for remote Hawaii is not delivered the next business day. Delivery to this zone requires an additional day.

**For each UPS Next Day Air package with a weight of more than 150 pounds, multiply the weight by the price per pound.

Note: For additional information, refer to page 28.

Domestic

UPS Next Day Air Saver®

Guaranteed on-time delivery to commercial destinations within the 48 contiguous states by 3:00 p.m. or 4:30 p.m. the next business day where UPS Next Day Air® delivery is committed by 10:30 a.m. or 12:00 p.m., respectively. Shipments to residential locations within the UPS Next Day Air Saver area are delivered by end of day. Not available to destinations where UPS Next Day Air service is committed by end of day. Optional Saturday pickup available. Saturday Delivery is not available.

Zones	132	133	134	135	136	137	138
Letter*	\$31.91	\$38.74	\$47.53	\$51.05	\$52.08	\$57.07	\$59.69
1 Lbs.	36.79	50.13	66.75	73.95	80.14	87.10	91.81
2	39.23	53.64	76.75	83.42	92.24	99.77	106.45
3	42.65	56.75	85.12	92.41	98.60	109.79	116.35
4	46.00	60.17	92.21	101.28	111.73	119.48	127.40
5	46.81	60.68	98.10	110.11	114.20	122.09	128.97
6	49.40	69.11	109.13	117.40	129.12	136.40	145.12
7	51.00	72.13	116.80	127.57	138.31	146.67	155.06
8	53.67	74.19	123.32	135.82	147.63	157.07	164.76
9	55.52	77.39	131.45	144.52	151.59	167.46	175.43
10	55.80	79.59	133.80	146.80	153.69	169.60	177.56
11	59.82	83.97	147.37	163.59	177.07	189.44	195.15
12	61.81	88.25	155.48	171.06	185.71	199.74	205.58
13	62.50	92.67	162.90	179.00	193.26	210.32	215.47
14	64.92	96.28	171.19	186.57	200.72	219.50	226.16
15	67.41	99.54	175.62	194.09	204.44	226.76	234.62
16	68.84	100.56	185.62	201.25	215.06	232.65	240.61
17	70.32	103.88	190.90	207.75	220.07	237.94	245.74
18	74.50	105.05	196.64	212.03	224.90	243.05	252.32
19	76.49	109.50	201.32	216.51	229.98	248.49	258.81
20	77.92	112.74	206.78	224.87	231.41	254.08	259.88
21	80.00	114.93	219.12	232.26	249.93	265.92	280.72
22	82.83	117.36	224.78	246.58	251.81	284.95	292.61
23	84.23	119.60	231.01	252.84	260.67	288.04	293.80
24	86.34	121.60	233.68	256.06	265.60	291.80	300.31
25	87.51	124.13	236.29	256.88	266.75	295.18	301.48
26	87.76	127.63	251.07	273.07	289.36	303.05	317.41
27	91.73	131.16	257.71	277.78	295.49	310.90	332.42
28	92.14	134.56	265.14	285.71	297.66	318.22	341.12
29	93.91	137.08	271.61	287.38	297.93	327.91	343.01
30	98.20	138.59	272.26	290.05	299.29	329.40	343.68
31	100.01	140.18	284.00	303.84	322.75	341.29	357.15
32	102.10	142.59	290.17	305.22	329.16	343.02	363.22
33	104.35	145.45	296.10	318.44	335.35	361.07	378.39
34	106.16	148.70	302.82	324.16	335.98	368.94	380.19
35	109.18	151.64	303.50	329.41	336.60	375.99	383.89

*The Letter rate applies only to documents, correspondence and electronic media shipments that do not exceed eight ounces and are sent in a UPS Express® Envelope.

Note: For additional information, refer to page [28](#).

Domestic

UPS Next Day Air Saver[®]

Zones	132	133	134	135	136	137	138
36 Lbs.	\$109.86	\$154.89	\$316.23	\$336.43	\$349.03	\$381.79	\$392.45
37	110.12	156.98	324.02	345.65	366.92	390.70	406.39
38	112.07	160.14	329.39	353.90	373.11	396.31	407.80
39	114.92	160.52	335.42	359.99	373.73	403.32	415.38
40	120.11	167.86	336.05	360.60	374.83	407.81	416.32
41	122.17	170.01	348.35	370.30	396.58	413.84	435.18
42	124.45	172.53	353.07	376.25	398.76	415.45	445.20
43	126.52	176.22	362.57	386.81	406.34	436.59	464.98
44	128.70	179.41	368.93	397.87	413.77	443.96	473.28
45	130.80	183.24	373.15	402.01	414.53	451.45	474.27
46	132.77	186.35	379.42	413.48	429.51	456.81	493.35
47	135.61	190.18	380.06	415.18	431.62	458.21	495.26
48	137.59	193.95	380.34	418.43	431.86	466.86	495.55
49	139.69	197.80	380.57	418.79	432.10	467.76	495.79
50	142.43	200.70	381.64	420.74	433.90	469.76	497.30
51	144.46	204.76	402.20	459.85	469.60	509.52	526.96
52	147.36	207.84	431.56	469.22	487.48	520.53	557.01
53	150.04	212.18	438.17	478.84	489.27	531.79	567.20
54	152.01	216.38	445.37	479.80	489.77	543.74	570.10
55	154.96	220.89	448.70	481.02	491.03	551.48	570.57
56	157.78	224.70	449.20	494.73	505.01	559.19	571.05
57	161.20	229.43	450.09	496.11	507.39	559.97	571.55
58	162.36	234.72	450.65	496.59	518.16	561.52	573.13
59	162.88	240.73	461.81	504.37	519.26	563.14	604.51
60	163.81	246.09	462.93	505.15	520.36	595.38	607.65
61	164.31	250.70	482.30	520.29	542.16	614.54	627.21
62	164.84	254.29	489.92	526.99	544.45	623.58	642.77
63	175.37	259.32	494.49	527.77	547.05	632.75	645.77
64	181.48	260.41	494.99	543.08	564.56	644.52	670.34
65	186.97	268.45	499.41	549.22	568.21	654.78	678.10
66	190.39	269.28	520.99	566.90	586.20	655.82	679.53
67	193.14	279.92	523.15	568.67	588.01	656.30	680.01
68	194.15	285.11	523.64	575.92	588.54	656.80	684.06
69	194.66	289.77	524.20	577.58	589.50	657.28	697.47
70	204.24	295.81	524.68	578.10	590.03	658.71	698.82
71	208.14	300.50	526.46	579.16	591.16	687.30	701.43
72	208.66	305.18	561.57	599.23	611.60	715.23	735.74
73	209.55	312.02	565.10	601.24	613.64	720.99	756.96
74	210.38	312.74	565.64	601.73	614.15	721.61	759.09
75	222.33	320.48	566.64	602.75	615.18	722.59	760.07

Note: For additional information, refer to page 28.

Domestic

UPS Next Day Air Saver[®]

Zones	132	133	134	135	136	137	138
76 Lbs.	\$223.54	\$321.58	\$569.76	\$608.07	\$620.57	\$742.14	\$761.05
77	227.18	322.66	572.17	628.10	646.45	744.12	762.04
78	228.33	337.42	593.84	643.25	663.81	745.10	763.02
79	229.34	338.90	596.01	653.11	673.90	758.22	773.76
80	230.43	349.14	597.01	655.25	675.88	761.44	777.04
81	231.45	355.04	615.23	696.49	712.67	781.06	797.04
82	246.85	360.79	618.59	700.62	716.36	783.02	799.05
83	248.39	363.41	619.60	701.64	717.37	784.05	800.11
84	249.41	364.44	620.64	702.66	718.42	800.44	816.87
85	250.42	365.52	621.67	703.67	719.40	802.10	818.55
86	255.86	370.48	623.50	706.30	720.79	803.09	819.53
87	257.12	371.29	646.56	709.53	724.11	804.34	820.80
88	258.16	372.09	648.88	711.11	726.01	807.48	824.94
89	263.83	372.91	676.38	742.70	763.79	870.15	907.43
90	264.64	373.72	683.79	747.14	773.57	904.37	924.38
91	265.44	374.53	684.60	748.12	774.56	907.81	926.09
92	266.25	375.34	685.41	749.10	775.55	908.80	927.18
93	267.07	376.15	686.21	750.08	776.52	909.78	928.27
94	267.88	376.96	687.02	751.06	777.49	911.10	929.38
95	268.68	377.74	687.83	753.27	778.51	912.09	930.49
96	269.49	378.57	688.64	761.77	784.40	913.07	931.47
97	270.29	379.38	689.45	768.18	792.43	914.03	932.69
98	271.11	380.19	690.26	770.36	809.50	916.21	934.89
99	271.92	381.00	691.07	808.65	830.19	959.71	978.92
100	272.70	381.78	691.85	815.07	832.24	1,012.02	1,055.45
101	275.45	385.62	698.79	823.24	840.58	1,022.15	1,066.02
102	278.17	389.43	705.70	831.39	848.90	1,032.28	1,076.58
103	280.90	393.25	712.61	839.54	857.22	1,042.39	1,087.13
104	283.62	397.06	719.55	847.68	865.55	1,052.52	1,097.68
105	286.35	400.88	726.46	855.84	873.87	1,062.64	1,108.24
106	289.07	404.69	733.37	863.98	882.19	1,072.75	1,118.79
107	291.80	408.53	740.29	872.14	890.52	1,082.88	1,129.35
108	294.53	412.34	747.22	880.29	898.84	1,093.00	1,139.91
109	297.26	416.16	754.13	888.45	907.16	1,103.12	1,150.46
110	299.99	419.97	761.05	896.59	915.48	1,113.24	1,161.01
111	302.72	423.79	767.97	904.74	923.81	1,123.36	1,171.56
112	305.44	427.60	774.89	912.89	932.13	1,133.48	1,182.12
113	308.17	431.43	781.81	921.04	940.44	1,143.60	1,192.68
114	310.89	435.24	788.72	929.19	948.78	1,153.71	1,203.23
115	313.62	439.07	795.64	937.35	957.09	1,163.84	1,213.79

Note: For additional information, refer to page [28](#).

Domestic

UPS Next Day Air Saver®

Zones	132	133	134	135	136	137	138
116 Lbs.	\$316.35	\$442.88	\$802.56	\$945.50	\$965.42	\$1,173.96	\$1,224.33
117	319.07	446.70	809.48	953.65	973.73	1,184.08	1,234.89
118	321.80	450.51	816.40	961.79	982.07	1,194.20	1,245.45
119	324.52	454.34	823.31	969.95	990.38	1,204.32	1,256.00
120	327.26	458.15	830.24	978.09	998.71	1,214.44	1,266.56
121	329.98	461.97	837.15	986.25	1,007.03	1,224.56	1,277.12
122	332.71	465.79	844.07	994.40	1,015.35	1,234.69	1,287.66
123	335.43	469.61	851.00	1,002.56	1,023.67	1,244.79	1,298.22
124	338.17	473.42	857.91	1,010.70	1,031.99	1,254.92	1,308.77
125	340.89	477.23	864.82	1,018.86	1,040.32	1,265.05	1,319.32
126	343.62	481.06	871.75	1,027.00	1,048.64	1,275.16	1,329.89
127	346.34	484.87	878.67	1,035.15	1,056.96	1,285.29	1,340.44
128	349.07	488.69	885.58	1,043.30	1,065.29	1,295.39	1,350.99
129	351.79	492.51	892.51	1,051.46	1,073.61	1,305.52	1,361.55
130	354.53	496.33	899.42	1,059.61	1,081.93	1,315.65	1,372.10
131	357.26	500.14	906.34	1,067.76	1,090.24	1,325.76	1,382.65
132	359.99	503.97	913.25	1,075.91	1,098.58	1,335.88	1,393.21
133	362.71	507.78	920.18	1,084.06	1,106.89	1,346.00	1,403.77
134	365.43	511.60	927.09	1,092.20	1,115.22	1,356.12	1,414.32
135	368.16	515.41	934.01	1,100.36	1,123.54	1,366.25	1,424.87
136	370.88	519.24	940.94	1,108.51	1,131.87	1,376.37	1,435.43
137	373.61	523.05	947.85	1,116.67	1,140.18	1,386.48	1,445.97
138	376.33	526.88	954.76	1,124.81	1,148.52	1,396.60	1,456.54
139	379.07	530.69	961.69	1,132.97	1,156.83	1,406.73	1,467.10
140	381.80	534.51	968.61	1,141.11	1,165.16	1,416.85	1,477.64
141	384.53	538.32	975.52	1,149.27	1,173.47	1,426.96	1,488.20
142	387.25	542.14	982.44	1,157.41	1,181.81	1,437.08	1,498.76
143	389.98	545.96	989.37	1,165.58	1,190.12	1,447.20	1,509.30
144	392.70	549.79	996.28	1,173.72	1,198.44	1,457.33	1,519.87
145	395.43	553.60	1,003.19	1,181.87	1,206.77	1,467.45	1,530.43
146	398.15	557.42	1,010.11	1,190.02	1,215.09	1,477.56	1,540.97
147	400.89	561.23	1,017.04	1,198.17	1,223.41	1,487.69	1,551.53
148	403.61	565.05	1,023.95	1,206.32	1,231.73	1,497.80	1,562.08
149	406.34	568.86	1,030.87	1,214.47	1,240.06	1,507.93	1,572.63
150	409.07	572.67	1,037.79	1,222.62	1,248.38	1,518.03	1,583.19
More Than 150 Pounds*							
Price Per Pound	\$2.73	\$3.82	\$6.92	\$8.15	\$8.32	\$10.12	\$10.55

*For each UPS Next Day Air Saver package with a weight of more than 150 pounds, multiply the weight by the price per pound.

Note: For additional information, refer to page [28](#).

Domestic

UPS 2nd Day Air A.M.^{®*}

Delivery by 10:30 a.m. or 12:00 p.m. on the second business day to metropolitan commercial destinations in the 48 contiguous states where UPS Next Day Air[®] delivery is committed by 10:30 a.m. or 12:00 p.m., respectively. Not available to destinations where UPS Next Day Air service is committed by end of day. Also not available to residential destinations. Optional Saturday pickup available. Saturday Delivery is not available.

Zones	242	243	244	245	246	247	248
Letter**	\$25.27	\$26.78	\$28.22	\$32.68	\$38.49	\$42.95	\$43.84
1 Lbs.	26.68	28.30	31.00	37.17	43.81	46.76	47.77
2	27.15	28.86	31.27	39.59	48.48	53.88	56.68
3	27.58	29.80	33.13	43.63	55.68	62.38	66.20
4	28.41	30.82	35.87	50.78	64.09	72.53	75.04
5	29.24	31.85	39.86	56.17	71.35	80.38	85.18
6	30.52	33.04	43.43	61.34	80.30	89.24	93.28
7	31.82	37.34	47.11	66.62	88.66	99.11	102.27
8	33.10	40.40	50.39	72.67	98.45	109.22	113.06
9	34.85	43.53	54.46	78.03	108.70	117.00	123.51
10	36.51	44.99	58.44	83.32	113.39	127.26	132.65
11	38.13	46.30	59.46	84.99	117.35	132.82	135.52
12	41.41	51.52	64.47	94.96	134.35	149.01	154.71
13	42.99	53.16	65.68	99.30	140.46	153.05	160.13
14	45.10	55.50	71.30	105.49	149.04	164.45	167.86
15	48.26	58.39	74.77	109.56	159.56	170.65	177.21
16	50.15	60.35	78.03	113.13	166.55	179.39	184.68
17	50.91	62.13	81.43	120.79	170.88	189.71	193.13
18	54.15	65.60	84.35	124.96	181.26	197.29	201.63
19	54.66	65.96	86.45	130.07	187.93	207.17	212.15
20	54.94	68.75	89.77	133.00	191.00	209.78	215.95
21	60.35	71.09	93.14	140.06	201.50	220.81	229.38
22	61.04	72.84	98.92	143.99	208.10	225.03	237.70
23	63.49	78.73	102.50	148.10	215.60	237.66	247.50
24	66.12	79.78	105.26	153.85	219.27	246.99	256.34
25	66.74	81.45	106.23	159.17	230.71	254.67	264.29
26	68.77	83.68	111.76	164.34	238.57	263.43	271.33
27	69.91	87.38	115.62	170.15	246.66	272.31	279.03
28	71.61	88.34	116.55	174.17	252.98	279.30	286.88
29	75.26	88.61	119.01	178.35	254.98	285.22	292.24
30	76.89	93.05	120.84	183.85	261.93	290.22	296.03
31	78.08	96.11	124.07	187.95	272.98	300.42	310.77
32	78.31	101.61	127.60	188.93	280.97	305.79	312.93
33	81.44	102.44	135.56	196.61	288.49	313.37	319.66
34	83.99	102.59	136.58	199.73	297.20	323.65	336.66
35	85.69	103.81	136.77	202.67	300.52	325.72	338.82

*Visit [ups.com/holidays](https://www.ups.com/holidays) for time-in-transit changes effective during the holiday season.

**The Letter rate applies only to documents, correspondence and electronic media shipments that do not exceed eight ounces and are sent in a UPS Express[®] Envelope.

Note: For additional information, refer to page [28](#).

Domestic

UPS 2nd Day Air A.M.^{®*}

Zones	242	243	244	245	246	247	248
36 Lbs.	\$88.54	\$108.20	\$139.62	\$207.79	\$308.56	\$335.44	\$352.25
37	88.84	109.47	141.12	210.92	316.92	342.22	355.60
38	91.11	110.99	146.41	211.14	330.15	350.04	357.06
39	94.73	112.70	146.96	215.59	339.16	366.59	379.53
40	95.15	115.66	152.63	231.14	346.86	370.82	388.53
41	99.61	119.75	154.41	232.92	354.72	389.09	400.51
42	102.35	124.90	158.85	240.37	355.58	398.67	409.98
43	104.02	125.43	162.99	244.38	365.68	404.57	417.58
44	105.13	126.75	169.08	248.73	378.01	411.37	425.76
45	105.40	129.76	174.14	252.22	384.93	419.11	432.13
46	105.70	135.96	178.31	256.02	390.94	427.49	444.28
47	110.03	137.45	178.83	259.60	391.66	432.44	450.27
48	112.22	137.55	183.85	263.43	406.06	439.84	450.32
49	112.78	141.96	185.29	266.73	413.09	441.56	453.20
50	113.95	149.56	189.38	272.39	419.95	453.62	461.40
51	120.45	151.34	190.95	278.16	442.87	469.03	495.31
52	126.14	156.60	195.27	279.16	448.82	477.23	497.09
53	126.95	157.17	205.26	279.82	449.43	485.60	497.31
54	127.51	160.67	206.27	292.65	449.98	489.75	503.88
55	128.05	161.18	206.79	293.94	450.47	499.84	504.85
56	130.18	161.65	207.27	294.73	450.94	501.59	506.61
57	131.95	162.16	207.77	309.19	451.61	507.27	512.36
58	132.53	163.27	208.28	310.62	452.10	513.27	527.15
59	135.59	166.73	212.80	311.23	457.28	520.24	529.20
60	136.45	172.60	213.66	323.02	474.62	534.51	541.19
61	136.94	173.52	214.18	324.23	476.78	535.64	555.20
62	137.42	174.09	218.79	324.86	479.34	540.99	556.60
63	141.06	180.25	223.88	337.45	530.43	552.94	558.46
64	145.91	182.32	227.62	338.74	535.80	569.52	595.09
65	146.41	182.84	233.33	339.23	550.21	600.30	619.98
66	146.89	186.87	238.35	344.35	551.92	603.34	622.64
67	148.14	188.39	238.91	344.91	552.47	603.85	622.76
68	148.28	189.82	239.47	345.50	552.97	606.75	622.90
69	150.48	190.40	240.10	346.02	558.60	608.39	629.53
70	152.00	200.36	248.04	346.59	559.16	623.14	630.58
71	155.46	203.39	251.35	350.66	574.79	631.16	637.56
72	158.92	203.89	258.62	352.37	576.52	643.01	649.45
73	160.37	204.39	262.28	355.32	582.54	644.20	650.65
74	161.10	204.88	262.85	355.91	583.15	657.71	664.32
75	161.14	206.18	263.87	357.06	584.12	660.19	666.80

*Visit [ups.com/holidays](https://www.ups.com/holidays) for time-in-transit changes effective during the holiday season.

Note: For additional information, refer to page 28.

Domestic

UPS 2nd Day Air A.M.^{®*}

Zones	242	243	244	245	246	247	248
76 Lbs.	\$172.54	\$207.18	\$264.88	\$362.96	\$585.09	\$663.65	\$679.22
77	173.71	208.19	265.89	378.01	586.05	664.66	680.47
78	174.79	209.27	266.89	380.56	598.90	665.95	681.97
79	175.90	210.36	268.60	409.43	623.67	684.89	714.60
80	176.86	213.58	269.41	412.32	626.17	722.35	729.61
81	177.86	214.68	269.94	413.32	628.69	727.81	746.85
82	179.17	230.05	286.77	421.73	672.05	741.15	748.57
83	183.47	232.96	288.47	422.88	681.59	749.69	760.25
84	185.78	233.96	289.46	424.03	690.55	750.91	761.43
85	188.65	234.95	291.22	432.80	692.36	752.23	762.40
86	189.63	235.95	292.32	434.35	692.77	753.21	763.36
87	190.26	237.05	293.68	459.81	693.16	754.20	764.32
88	192.05	238.23	294.69	462.38	693.94	758.56	768.19
89	193.04	239.24	295.70	463.51	698.49	761.10	769.92
90	193.43	244.91	296.72	464.65	699.59	773.67	804.81
91	194.14	245.90	297.80	465.78	700.68	794.26	808.34
92	196.45	246.90	314.70	466.33	701.78	812.91	824.04
93	197.56	247.91	316.39	466.87	702.88	814.54	825.64
94	199.86	248.91	325.46	467.45	703.98	815.68	826.77
95	200.85	250.46	326.47	467.99	717.05	819.68	827.89
96	201.86	251.46	327.48	471.52	760.14	824.74	833.02
97	202.85	252.69	328.48	471.59	764.47	827.12	835.41
98	203.85	253.67	329.50	471.65	766.24	844.08	862.02
99	208.80	254.69	330.83	474.07	795.91	868.94	879.75
100	221.02	270.73	355.68	527.74	820.30	884.25	922.58
101	223.22	273.45	359.23	533.02	828.51	893.09	931.83
102	225.44	276.15	362.80	538.28	836.71	901.92	941.03
103	227.64	278.86	366.35	543.57	844.89	910.78	950.25
104	229.85	281.55	369.91	548.85	853.11	919.61	959.48
105	232.07	284.25	373.46	554.12	861.30	928.46	968.70
106	234.28	286.98	377.01	559.40	869.52	937.30	977.93
107	236.48	289.69	380.58	564.68	877.74	946.14	987.15
108	238.70	292.39	384.13	569.96	885.91	954.98	996.39
109	240.90	295.09	387.70	575.23	894.13	963.82	1,005.60
110	243.12	297.82	391.25	580.50	902.32	972.67	1,014.84
111	245.31	300.51	394.80	585.79	910.54	981.51	1,024.07
112	247.53	303.22	398.37	591.07	918.72	990.34	1,033.28
113	249.75	305.93	401.92	596.34	926.94	999.20	1,042.50
114	251.95	308.64	405.48	601.62	935.13	1,008.03	1,051.73
115	254.16	311.34	409.03	606.90	943.34	1,016.88	1,060.95

*Visit [ups.com/holidays](https://www.ups.com/holidays) for time-in-transit changes effective during the holiday season.

Note: For additional information, refer to page 28.

Domestic

UPS 2nd Day Air A.M.^{®*}

Zones	242	243	244	245	246	247	248
116 Lbs.	\$256.38	\$314.06	\$412.58	\$612.17	\$951.54	\$1,025.72	\$1,070.19
117	258.58	316.77	416.15	617.45	959.73	1,034.57	1,079.43
118	260.80	319.47	419.70	622.73	967.95	1,043.40	1,088.64
119	263.01	322.16	423.26	628.00	976.15	1,052.24	1,097.86
120	265.21	324.87	426.81	633.29	984.37	1,061.09	1,107.09
121	267.43	327.59	430.36	638.56	992.56	1,069.93	1,116.32
122	269.63	330.28	433.94	643.83	1,000.76	1,078.77	1,125.55
123	271.85	333.00	437.49	649.11	1,008.94	1,087.62	1,134.77
124	274.05	335.71	441.04	654.40	1,017.16	1,096.45	1,143.99
125	276.26	338.41	444.60	659.67	1,025.37	1,105.30	1,153.21
126	278.48	341.11	448.15	664.95	1,033.57	1,114.14	1,162.43
127	280.69	343.84	451.72	670.21	1,041.78	1,122.99	1,171.65
128	282.89	346.54	455.27	675.50	1,049.96	1,131.82	1,180.88
129	285.10	349.26	458.82	680.78	1,058.18	1,140.66	1,190.11
130	287.31	351.96	462.38	686.05	1,066.38	1,149.51	1,199.34
131	289.53	354.67	465.93	691.33	1,074.58	1,158.35	1,208.57
132	291.73	357.36	469.50	696.62	1,082.78	1,167.19	1,217.80
133	293.94	360.06	473.05	701.88	1,090.99	1,176.04	1,227.03
134	296.15	362.77	476.60	707.16	1,099.19	1,184.89	1,236.24
135	298.37	365.48	480.16	712.44	1,107.38	1,193.72	1,245.45
136	300.58	368.19	483.72	717.71	1,115.59	1,202.57	1,254.69
137	302.78	370.89	487.29	723.00	1,123.81	1,211.41	1,263.92
138	304.99	373.61	490.84	728.28	1,132.01	1,220.25	1,273.15
139	307.20	376.32	494.39	733.54	1,140.19	1,229.09	1,282.37
140	309.42	379.03	497.95	738.82	1,148.40	1,237.94	1,291.60
141	311.62	381.73	501.50	744.11	1,156.61	1,246.77	1,300.83
142	313.83	384.45	505.07	749.38	1,164.81	1,255.62	1,310.05
143	316.05	387.15	508.62	754.66	1,173.01	1,264.46	1,319.28
144	318.25	389.86	512.17	759.94	1,181.22	1,273.31	1,328.48
145	320.46	392.56	515.73	765.21	1,189.42	1,282.18	1,337.70
146	322.68	395.27	519.28	770.49	1,197.63	1,290.99	1,346.93
147	324.88	397.96	522.85	775.77	1,205.83	1,299.83	1,356.17
148	327.10	400.66	526.40	781.04	1,214.04	1,308.67	1,365.42
149	329.29	403.40	529.95	786.33	1,222.22	1,317.51	1,374.63
150	331.51	406.09	533.52	791.61	1,230.43	1,326.36	1,383.86
More Than 150 Pounds**							
Price Per Pound	\$2.21	\$2.71	\$3.56	\$5.28	\$8.20	\$8.84	\$9.23

*Visit [ups.com/holidays](https://www.ups.com/holidays) for time-in-transit changes effective during the holiday season.

**For each UPS 2nd Day Air A.M. package with a weight of more than 150 pounds, multiply the weight by the price per pound.

Note: For additional information, refer to page [28](#).

Domestic

UPS 2nd Day Air^{®*}

Delivery to all 50 states and Puerto Rico, with some limitations in Alaska and Hawaii, by the end of the second business day. Optional Saturday Delivery and pickup available.

Zones	202	203	204	205	206	207	208	224**	225**	226**
Letter***	\$23.92	\$24.95	\$26.02	\$30.99	\$37.22	\$39.70	\$40.51	\$58.66	\$53.93	\$70.46
1 Lbs.	24.07	25.09	26.16	31.29	37.60	40.11	40.92	59.25	55.26	72.06
2	24.81	26.18	27.17	33.72	42.32	46.94	49.37	66.16	60.65	88.11
3	25.20	26.96	28.76	37.22	48.64	54.41	56.65	75.49	69.18	92.07
4	25.97	27.92	31.15	43.37	56.07	62.00	64.34	80.42	73.79	96.22
5	26.76	28.82	33.86	48.10	62.64	68.93	73.06	87.26	80.02	99.96
6	27.92	30.01	36.90	52.51	69.48	76.59	80.00	98.10	85.30	105.81
7	29.09	32.74	40.03	57.39	78.16	84.70	87.97	99.81	91.77	110.93
8	30.25	35.72	42.81	62.61	86.33	93.31	96.80	111.22	97.16	116.80
9	31.80	37.29	46.25	67.22	93.73	102.31	106.13	113.06	103.23	123.60
10	32.07	39.76	49.80	71.80	100.46	111.29	114.92	129.11	112.20	131.86
11	34.88	41.92	52.10	76.78	108.22	119.47	124.41	131.52	118.68	137.17
12	36.73	44.40	54.98	81.10	116.59	128.15	131.67	134.32	125.50	137.81
13	39.31	46.70	57.09	85.97	124.20	134.38	140.80	146.86	130.14	149.60
14	41.29	49.12	60.80	90.92	131.78	141.19	147.05	152.61	135.09	155.36
15	42.84	50.24	63.76	94.43	138.78	147.44	153.72	159.64	140.24	162.38
16	43.85	51.90	66.40	97.50	144.60	154.99	160.24	166.19	146.54	168.94
17	45.19	53.45	69.10	102.19	151.11	163.28	167.68	174.12	152.63	176.89
18	46.71	55.22	71.81	105.72	157.37	170.49	175.78	179.30	160.19	181.67
19	48.57	56.73	73.75	110.04	163.03	178.32	183.40	190.52	168.59	193.25
20	50.23	59.18	76.61	115.17	168.83	184.45	190.23	197.27	174.76	199.99
21	52.58	61.48	79.48	119.05	169.50	190.79	196.75	200.70	181.29	200.88
22	54.20	64.44	81.67	122.41	180.52	198.07	204.39	208.47	189.65	214.21
23	55.53	65.87	84.60	125.89	187.06	204.58	211.38	215.64	196.64	215.80
24	56.80	68.48	87.30	130.78	193.87	209.42	213.63	217.91	203.87	223.21
25	58.64	70.44	88.96	135.27	200.18	220.08	229.28	238.30	211.04	241.06
26	60.39	72.38	92.26	139.71	206.98	227.63	235.59	244.52	212.60	247.91
27	62.32	74.49	94.60	144.65	213.99	235.29	242.99	252.43	219.31	255.22
28	64.33	76.93	96.79	148.09	219.47	241.35	248.88	260.54	226.28	264.65
29	65.99	78.36	99.65	151.61	225.37	247.40	256.28	267.10	232.44	272.37
30	66.25	80.49	103.09	156.56	231.55	254.08	262.78	275.58	239.27	279.62
31	66.51	83.19	105.87	160.08	236.84	259.59	269.81	282.36	245.87	288.38
32	66.80	85.04	108.90	163.96	243.78	266.80	276.32	291.23	253.05	295.82
33	72.33	87.26	111.93	167.46	250.32	272.94	283.35	292.91	259.93	304.07
34	74.58	88.87	114.28	173.32	257.89	279.72	290.32	297.75	266.68	305.70
35	76.10	91.57	116.74	176.74	265.64	286.75	294.51	298.36	273.83	306.06

*Visit [ups.com/holidays](https://www.ups.com/holidays) for time-in-transit changes effective during the holiday season.

**Zone 224 is metro Alaska and Hawaii, Zone 225 is Puerto Rico, and Zone 226 is remote Alaska and Hawaii.

***The Letter rate applies only to documents, correspondence and electronic media shipments that do not exceed eight ounces and are sent in a UPS Express[®] Envelope.

Note: For additional information, refer to page [28](#).

Domestic

UPS 2nd Day Air^{®*}

Zones	202	203	204	205	206	207	208	224**	225**	226**
36 Lbs.	\$77.28	\$93.57	\$119.16	\$180.38	\$272.78	\$295.78	\$302.11	\$305.98	\$285.85	\$312.67
37	78.72	94.92	122.04	185.04	280.19	303.67	313.13	330.94	293.07	333.14
38	80.04	96.37	125.13	188.78	287.33	311.55	321.68	335.23	299.98	335.56
39	82.57	98.91	127.24	192.54	294.28	319.85	330.04	346.71	306.93	353.65
40	82.83	101.53	130.28	196.87	300.96	327.68	337.33	353.63	313.16	362.32
41	86.85	103.99	131.79	200.49	307.76	336.24	346.44	361.36	319.84	365.67
42	88.28	106.52	134.48	204.72	314.36	344.52	355.15	369.65	327.23	373.85
43	90.12	108.72	136.54	208.13	321.75	350.92	362.56	376.49	333.63	383.26
44	91.64	110.06	139.63	211.84	328.02	356.88	369.70	383.97	339.86	389.89
45	92.05	112.76	141.66	214.79	334.00	363.56	375.20	389.56	345.06	397.48
46	94.89	114.03	144.50	216.97	339.64	369.42	384.29	392.50	353.36	398.39
47	95.19	114.28	146.91	217.62	340.26	370.02	387.95	392.86	360.07	398.67
48	97.18	118.88	149.53	218.25	352.43	381.52	391.10	398.77	366.29	398.94
49	97.44	119.36	149.82	218.37	358.42	382.71	391.43	399.27	373.21	399.60
50	97.71	119.62	154.50	218.54	364.56	384.29	392.00	399.83	373.32	400.17
51	98.61	120.14	157.92	225.58	382.11	395.08	403.00	411.03	385.85	413.77
52	105.57	126.59	162.99	237.99	387.92	419.07	433.11	437.79	386.70	440.56
53	107.68	129.15	165.29	239.74	388.50	426.38	436.08	440.47	392.45	443.22
54	109.21	130.71	167.86	240.31	389.35	428.12	436.63	441.03	397.32	447.61
55	111.21	131.23	169.34	240.85	406.01	428.66	437.17	441.56	409.34	451.44
56	112.11	131.75	169.89	241.54	407.71	429.18	437.73	442.14	410.50	451.50
57	112.63	137.43	175.09	255.18	420.98	437.85	446.57	451.05	417.92	459.86
58	113.16	138.01	175.61	256.56	428.95	438.74	447.46	451.94	424.96	460.01
59	113.68	138.83	181.69	257.13	435.47	444.18	453.09	462.10	430.68	464.85
60	114.21	139.35	182.71	264.30	437.79	454.04	463.14	472.35	435.94	475.10
61	114.72	139.89	183.24	265.02	444.00	457.76	466.94	475.51	443.71	478.27
62	115.24	140.40	183.78	265.58	444.97	458.61	467.81	476.64	458.17	479.38
63	115.76	140.92	184.31	271.07	464.21	474.95	484.46	494.07	465.91	496.83
64	123.03	143.69	184.83	271.62	467.26	476.61	486.14	495.82	466.25	498.58
65	127.65	147.48	185.35	278.83	467.76	477.12	486.66	496.37	474.42	499.12
66	128.17	148.00	187.43	279.56	468.58	477.95	487.52	497.21	482.36	499.99
67	128.70	150.97	187.89	280.12	469.10	478.47	488.04	497.77	484.18	501.69
68	129.22	152.19	193.12	280.66	469.61	479.00	488.57	498.36	496.80	501.74
69	129.75	155.55	193.66	281.89	471.20	480.63	490.26	500.07	504.06	501.79
70	130.27	169.55	200.43	305.80	491.91	511.75	522.01	532.40	510.22	535.16
71	138.17	171.83	200.57	308.21	493.50	516.87	527.22	537.70	511.61	540.46
72	138.97	172.35	200.67	308.75	506.90	517.41	527.74	538.26	512.76	541.00
73	139.44	172.89	201.62	313.83	507.75	517.92	528.27	538.80	518.15	541.54
74	139.92	173.41	202.13	314.38	508.47	518.65	529.01	539.61	555.91	541.59
75	140.88	174.46	203.18	320.72	522.54	533.01	543.67	554.51	555.96	557.26

*Visit [ups.com/holidays](https://www.ups.com/holidays) for time-in-transit changes effective during the holiday season.

**Zone 224 is metro Alaska and Hawaii, Zone 225 is Puerto Rico, and Zone 226 is remote Alaska and Hawaii.

Note: For additional information, refer to page [28](#).

Domestic

UPS 2nd Day Air^{®*}

Zones	202	203	204	205	206	207	208	224**	225**	226**
76 Lbs.	\$143.56	\$175.50	\$204.22	\$323.03	\$530.73	\$541.33	\$552.16	\$563.14	\$556.01	\$565.92
77	144.60	176.56	208.39	324.13	541.66	558.00	569.17	580.19	556.06	582.92
78	145.65	177.60	212.40	339.67	543.15	562.38	609.69	619.68	556.11	622.44
79	146.71	178.65	213.45	341.24	546.05	601.72	613.75	625.99	573.29	628.74
80	147.76	179.70	214.50	342.34	575.76	605.87	618.00	630.24	573.39	635.84
81	152.88	180.65	215.54	343.45	578.75	606.91	619.06	631.36	574.25	637.96
82	154.37	181.58	218.76	344.55	579.85	607.96	620.13	632.47	599.55	638.17
83	156.45	184.43	219.80	345.66	588.99	609.01	621.19	633.57	603.99	639.27
84	157.50	185.49	223.09	346.76	595.30	619.29	631.68	644.24	604.17	647.02
85	164.76	189.71	232.18	360.94	596.40	620.33	632.75	645.35	605.81	648.52
86	165.83	195.56	233.33	362.37	597.49	621.31	633.75	646.75	605.99	649.47
87	166.87	197.94	234.36	363.47	598.58	625.50	638.01	650.74	615.99	653.49
88	167.92	199.60	235.41	364.58	599.67	630.35	642.97	655.71	623.75	658.44
89	168.95	199.80	236.45	365.68	607.07	631.38	644.03	656.80	624.28	659.55
90	170.01	199.87	237.51	366.80	613.37	632.45	645.11	657.91	633.62	660.65
91	171.05	200.79	238.54	367.89	614.45	633.49	646.18	658.99	634.14	661.75
92	172.10	201.84	239.59	368.99	615.55	634.53	647.25	660.19	639.79	661.81
93	173.15	202.88	242.40	370.10	616.64	635.57	648.30	661.27	639.95	661.86
94	174.21	203.94	242.58	371.20	617.73	636.64	649.38	662.37	661.63	662.92
95	175.24	204.98	243.45	372.33	619.62	642.31	655.14	668.27	661.80	668.82
96	177.80	205.93	249.68	378.90	630.72	643.34	656.21	669.36	664.87	669.91
97	178.60	207.08	255.72	380.01	643.99	656.88	670.01	683.42	665.47	683.98
98	179.40	208.14	256.76	381.12	659.05	672.26	685.63	692.50	665.65	708.44
99	180.20	209.18	262.82	403.30	663.75	695.53	724.53	738.97	666.20	744.93
100	181.00	226.00	291.00	425.00	674.72	764.04	795.95	811.00	714.73	820.09
101	182.81	228.26	293.91	429.25	684.16	777.70	801.94	818.10	721.86	828.26
102	184.62	230.52	296.82	433.50	688.98	785.40	809.88	826.20	729.01	836.42
103	186.43	232.78	299.73	437.75	695.73	793.10	817.82	834.30	736.17	844.61
104	188.24	235.04	302.64	442.00	700.96	800.80	825.76	842.40	743.31	852.77
105	190.05	237.30	305.55	446.25	709.25	808.50	833.70	850.50	750.44	860.94
106	191.86	239.56	308.46	450.50	716.00	816.20	841.64	858.60	757.58	869.13
107	193.67	241.82	311.37	454.75	721.18	823.90	849.58	866.70	764.76	877.30
108	195.48	244.08	314.28	459.00	727.92	831.60	857.52	874.80	771.90	885.47
109	197.29	246.34	317.19	463.25	734.66	839.30	865.46	882.90	779.05	893.65
110	199.10	248.60	320.10	467.50	743.00	847.00	873.40	891.00	786.20	901.82
111	200.91	250.86	323.01	471.75	748.14	854.70	881.34	899.10	793.34	909.99
112	202.72	253.12	325.92	476.00	756.52	862.40	889.28	907.20	800.49	918.16
113	204.53	255.38	328.83	480.25	761.62	870.10	897.22	915.30	807.62	926.34
114	206.34	257.64	331.74	484.50	768.36	877.80	905.16	923.40	814.77	934.51
115	208.15	259.90	334.65	488.75	775.10	885.50	913.10	931.50	821.93	942.68

*Visit [ups.com/holidays](https://www.ups.com/holidays) for time-in-transit changes effective during the holiday season.

**Zone 224 is metro Alaska and Hawaii, Zone 225 is Puerto Rico, and Zone 226 is remote Alaska and Hawaii.

Note: For additional information, refer to page [28](#).

Domestic

UPS 2nd Day Air^{®*}

Zones	202	203	204	205	206	207	208	224**	225**	226**
116 Lbs.	\$209.96	\$262.16	\$337.56	\$493.00	\$783.54	\$893.20	\$921.04	\$939.60	\$829.11	\$950.86
117	211.77	264.42	340.47	497.25	788.58	900.90	928.98	947.70	836.22	959.03
118	213.58	266.68	343.38	501.50	795.32	908.60	936.92	955.80	843.37	967.20
119	215.39	268.94	346.29	505.75	802.06	916.30	944.86	963.90	850.52	975.37
120	217.20	271.20	349.20	510.00	808.80	924.00	952.80	972.00	857.63	983.55
121	219.01	273.46	352.11	514.25	815.54	931.70	960.74	980.10	864.81	991.72
122	220.82	275.72	355.02	518.50	822.28	939.40	968.68	988.20	871.97	999.89
123	222.63	277.98	357.93	522.75	829.02	947.10	976.62	996.30	879.12	1,008.08
124	224.44	280.24	360.84	527.00	837.58	954.80	984.56	1,004.40	886.25	1,016.25
125	226.25	282.50	363.75	531.25	842.50	962.50	992.50	1,012.50	893.41	1,024.41
126	228.06	284.76	366.66	535.50	851.09	970.20	1,000.44	1,020.60	900.55	1,032.60
127	229.87	287.02	369.57	539.75	859.98	977.90	1,008.38	1,028.70	907.70	1,040.76
128	231.68	289.28	372.48	544.00	862.72	985.60	1,016.32	1,036.80	914.84	1,048.93
129	233.49	291.54	375.39	548.25	869.46	993.30	1,024.26	1,044.90	921.97	1,057.10
130	235.30	293.80	378.30	552.50	876.20	1,001.00	1,032.20	1,053.00	929.14	1,065.28
131	237.11	296.06	381.21	556.75	887.36	1,008.70	1,040.14	1,061.10	936.30	1,073.45
132	238.92	298.32	384.12	561.00	891.61	1,016.40	1,048.08	1,069.20	943.43	1,081.62
133	240.73	300.58	387.03	565.25	896.42	1,024.10	1,056.02	1,077.30	950.59	1,089.82
134	242.54	302.84	389.94	569.50	903.16	1,031.80	1,063.96	1,085.40	957.73	1,097.97
135	244.35	305.10	392.85	573.75	909.90	1,039.50	1,071.90	1,093.50	964.89	1,106.15
136	246.16	307.36	395.76	578.00	916.64	1,047.20	1,079.84	1,101.60	972.03	1,114.32
137	247.97	309.62	398.67	582.25	923.38	1,054.90	1,087.78	1,109.70	979.17	1,122.50
138	249.78	311.88	401.58	586.50	932.13	1,062.60	1,095.72	1,117.80	986.30	1,130.66
139	251.59	314.14	404.49	590.75	936.86	1,070.30	1,103.66	1,125.90	993.45	1,138.84
140	253.40	316.40	407.40	595.00	943.60	1,078.00	1,111.60	1,134.00	1,000.62	1,147.01
141	255.21	318.66	410.31	599.25	950.34	1,085.70	1,119.54	1,142.10	1,007.75	1,155.19
142	257.02	320.92	413.22	603.50	957.08	1,093.40	1,127.48	1,150.20	1,014.91	1,163.36
143	258.83	323.18	416.13	607.75	963.82	1,101.10	1,135.42	1,158.30	1,022.05	1,171.53
144	260.64	325.44	419.04	612.00	970.56	1,108.80	1,143.36	1,166.40	1,029.21	1,179.71
145	262.45	327.70	421.95	616.25	977.30	1,116.50	1,151.30	1,174.50	1,036.34	1,187.87
146	264.26	329.96	424.86	620.50	984.04	1,124.20	1,159.24	1,182.60	1,043.49	1,196.07
147	266.07	332.22	427.77	624.75	990.78	1,131.90	1,167.18	1,190.70	1,050.64	1,204.22
148	267.88	334.48	430.68	629.00	999.68	1,139.60	1,175.12	1,198.80	1,057.79	1,212.40
149	269.69	336.74	433.59	633.25	1,006.44	1,147.30	1,183.06	1,206.90	1,064.95	1,220.56
150	271.50	339.00	436.50	637.50	1,011.00	1,155.00	1,191.00	1,215.00	1,072.09	1,228.75
More Than 150 Pounds***										
Price Per Pound	\$1.81	\$2.26	\$2.91	\$4.25	\$6.74	\$7.70	\$7.94	\$8.10	\$7.15	\$8.19

*Visit [ups.com/holidays](https://www.ups.com/holidays) for time-in-transit changes effective during the holiday season.

**Zone 224 is metro Alaska and Hawaii, Zone 225 is Puerto Rico, and Zone 226 is remote Alaska and Hawaii.

***For each UPS 2nd Day Air package with a weight of more than 150 pounds, multiply the weight by the price per pound.

Note: For additional information, refer to page 28.

Domestic UPS 3 Day Select^{®*}

Delivery by the end of the third business day to the 48 contiguous states. Saturday Delivery and pickup available in select areas.

Zones	302	303	304	305	306	307	308
1 Lbs.	\$15.25	\$17.65	\$18.91	\$24.40	\$30.20	\$33.19	\$35.96
2	15.43	18.72	20.56	26.94	33.40	37.18	42.28
3	17.24	19.68	22.47	29.98	38.91	41.59	48.22
4	18.96	21.73	23.43	33.59	41.12	47.14	53.40
5	20.13	23.31	25.59	36.69	45.88	52.09	58.95
6	21.25	25.14	28.17	40.08	52.67	57.81	63.82
7	22.02	27.16	30.55	42.70	57.03	65.30	70.23
8	23.11	29.33	33.02	45.75	61.28	70.13	76.47
9	24.46	30.66	35.09	46.64	63.34	74.62	82.29
10	25.59	31.60	35.79	49.51	66.60	80.32	88.19
11	27.03	32.46	39.02	51.85	73.51	84.59	93.52
12	28.50	35.67	40.65	57.12	78.27	88.72	99.18
13	30.11	37.28	41.35	57.62	79.50	89.69	105.41
14	30.84	39.72	44.20	60.17	83.40	94.19	110.79
15	32.07	39.90	45.86	61.41	87.96	103.23	117.12
16	32.85	41.29	47.58	65.86	91.71	108.56	121.96
17	32.92	41.42	49.45	66.55	95.06	108.62	127.62
18	34.22	42.10	51.23	69.51	98.69	118.15	131.91
19	35.02	43.16	52.97	72.06	101.85	120.84	136.56
20	35.92	44.02	53.69	74.90	105.47	121.16	141.45
21	37.50	47.80	55.68	77.64	107.71	129.42	146.35
22	38.63	48.38	57.07	79.77	112.62	130.02	151.74
23	39.64	49.62	60.82	81.75	115.90	140.72	156.79
24	39.83	50.94	62.27	84.67	119.87	141.78	161.71
25	41.32	51.82	64.50	87.64	123.05	150.56	167.07
26	44.08	54.39	66.52	90.26	126.75	155.74	172.08
27	45.45	55.91	68.94	95.36	131.76	161.21	177.96
28	46.87	56.51	70.62	95.57	136.13	166.06	183.13
29	46.93	56.74	72.59	97.99	140.02	171.07	189.56
30	47.68	57.60	73.03	101.09	144.69	171.17	194.34
31	49.54	62.50	76.51	105.79	151.86	180.77	199.71
32	49.59	62.64	76.89	106.05	152.70	180.82	200.37
33	51.13	63.03	80.26	109.24	157.34	180.90	200.45
34	52.07	64.31	80.49	111.49	161.13	185.95	215.05
35	53.01	67.04	82.70	114.27	164.66	188.13	221.13

*Visit [ups.com/holidays](https://www.ups.com/holidays) for time-in-transit changes effective during the holiday season.

Notes:

- For additional information, refer to page 28.
- Shipments of Hazardous Materials using UPS 3 Day Select service must be prepared in accordance with the appropriate Air Dangerous Goods requirements. Hazardous Materials contract service is available with a Scheduled Pickup.

Domestic

UPS 3 Day Select^{®*}

Zones	302	303	304	305	306	307	308
36 Lbs.	\$55.03	\$68.73	\$85.89	\$116.94	\$169.33	\$194.65	\$226.23
37	55.80	69.20	86.28	119.94	172.76	198.57	226.86
38	56.25	69.82	88.61	122.90	176.39	201.45	227.59
39	57.82	70.39	90.37	125.26	180.44	212.07	240.30
40	58.30	70.48	91.24	126.32	184.47	212.74	244.47
41	61.41	75.98	93.60	130.64	187.66	213.44	249.67
42	62.39	78.08	97.03	134.27	191.73	217.81	254.96
43	63.67	80.05	98.88	136.67	195.61	222.64	261.05
44	64.23	80.99	101.31	139.59	199.24	227.32	261.12
45	65.06	81.90	103.18	142.36	202.63	231.47	262.34
46	65.78	83.06	107.49	147.46	208.78	240.82	277.82
47	66.01	83.20	108.08	148.06	211.46	241.02	279.47
48	66.13	84.74	108.52	153.16	217.27	256.54	288.71
49	66.60	85.96	110.28	153.69	219.01	260.91	290.66
50	66.80	86.27	110.76	153.82	220.13	263.25	291.14
51	71.51	86.56	114.11	158.99	230.36	263.95	305.06
52	73.81	92.41	114.78	161.68	234.04	264.02	308.20
53	74.70	94.93	116.71	163.62	237.99	270.48	315.87
54	75.65	95.76	119.15	166.66	241.53	275.79	321.55
55	76.16	97.58	120.85	169.63	245.38	280.97	321.61
56	77.24	97.94	122.66	172.24	245.56	286.03	322.16
57	77.56	98.78	124.77	174.81	248.86	294.38	323.49
58	78.09	99.64	126.30	177.60	254.20	296.87	328.84
59	78.42	100.62	128.20	180.02	257.11	301.81	334.75
60	81.02	104.14	128.97	180.25	262.03	303.56	340.83
61	81.09	104.19	131.94	186.55	267.28	311.86	346.54
62	81.14	105.85	133.64	189.13	272.12	317.25	351.85
63	81.20	106.32	135.37	191.81	275.98	322.35	357.67
64	83.92	108.58	136.81	194.97	281.53	328.48	363.37
65	84.39	110.00	136.88	195.76	285.99	332.32	372.02
66	87.05	110.92	139.78	199.91	289.13	337.78	379.82
67	87.15	112.83	141.64	202.93	293.42	343.02	380.74
68	87.25	113.97	144.30	205.52	297.61	347.85	396.99
69	87.67	117.25	145.55	207.75	300.30	349.40	404.17
70	88.60	117.66	147.53	209.56	300.56	353.15	404.24
71	90.30	120.47	150.78	212.77	310.18	362.06	409.07
72	93.04	122.15	152.62	215.57	313.03	367.12	410.56
73	95.93	124.14	155.25	218.27	316.78	370.83	411.98
74	96.74	125.37	157.31	221.62	322.01	373.01	416.70
75	97.22	125.54	159.21	224.39	324.94	373.17	418.05

*Visit [ups.com/holidays](https://www.ups.com/holidays) for time-in-transit changes effective during the holiday season.

Notes:

- For additional information, refer to page 28.
- Shipments of Hazardous Materials using UPS 3 Day Select service must be prepared in accordance with the appropriate Air Dangerous Goods requirements. Hazardous Materials contract service is available with a Scheduled Pickup.

Domestic UPS 3 Day Select^{®*}

Zones	302	303	304	305	306	307	308
76 Lbs.	\$97.83	\$125.87	\$159.91	\$227.79	\$330.53	\$387.32	\$447.79
77	101.87	126.70	162.15	230.41	334.64	392.25	447.85
78	101.92	127.00	163.81	232.14	334.82	398.85	447.93
79	103.03	128.72	164.03	233.43	335.96	400.49	447.99
80	103.10	130.34	165.83	233.59	336.12	401.88	448.06
81	103.59	132.40	166.74	235.91	336.56	402.84	450.61
82	104.40	134.80	169.38	239.91	357.15	415.16	455.75
83	105.97	136.29	169.44	242.63	357.50	416.36	461.21
84	107.08	143.15	169.49	245.77	357.94	417.32	465.62
85	107.56	143.21	171.72	251.16	369.44	428.43	472.82
86	112.44	145.32	175.40	253.51	374.90	432.65	478.82
87	113.76	150.72	177.65	255.45	376.59	442.30	484.11
88	113.84	152.80	178.63	258.93	376.96	442.48	488.81
89	113.90	155.01	180.39	261.60	382.32	448.09	493.46
90	113.99	156.88	182.88	265.13	387.64	449.93	498.49
91	122.36	157.99	184.09	267.45	387.79	452.18	506.71
92	122.65	158.09	185.74	271.01	389.81	453.73	512.62
93	122.90	158.14	188.17	272.90	390.06	466.14	518.25
94	123.08	158.36	190.21	279.25	398.69	468.73	524.66
95	123.23	159.15	191.49	284.52	402.13	474.82	556.01
96	123.47	159.94	191.55	289.80	405.28	475.06	559.04
97	124.01	161.35	196.88	293.41	410.09	484.54	568.05
98	124.69	161.55	197.10	294.60	410.38	491.62	572.52
99	132.79	162.57	202.70	304.98	430.11	506.32	578.97
100	132.84	168.70	207.66	311.83	447.91	531.52	594.19
101	132.89	170.39	211.02	315.66	453.62	536.91	600.91
102	133.93	172.05	214.53	318.09	456.81	542.19	606.76
103	135.65	172.99	216.56	321.95	461.49	547.30	612.79
104	136.55	173.80	218.58	324.17	465.82	552.70	618.54
105	138.27	174.62	220.63	328.43	470.21	558.02	624.76
106	139.21	175.27	222.96	330.54	474.69	564.94	630.60
107	140.53	176.51	224.43	333.49	479.28	568.80	636.47
108	141.78	178.80	227.04	336.88	483.88	573.93	642.47
109	143.45	180.74	229.79	340.80	489.55	579.33	648.52
110	144.15	181.91	231.32	343.95	493.98	584.61	654.37
111	145.49	183.60	233.19	346.10	497.17	589.82	660.30
112	146.80	185.28	235.53	349.14	501.66	595.23	666.16
113	147.34	186.81	237.57	352.20	505.99	600.41	672.18
114	150.05	188.47	240.45	356.51	510.56	605.84	678.30
115	151.40	190.18	241.72	359.56	516.59	611.15	683.96

*Visit [ups.com/holidays](https://www.ups.com/holidays) for time-in-transit changes effective during the holiday season.

Notes:

- For additional information, refer to page 28.
- Shipments of Hazardous Materials using UPS 3 Day Select service must be prepared in accordance with the appropriate Air Dangerous Goods requirements. Hazardous Materials contract service is available with a Scheduled Pickup.

Domestic UPS 3 Day Select^{®*}

Zones	302	303	304	305	306	307	308
116 Lbs.	\$152.66	\$192.43	\$243.84	\$362.72	\$519.54	\$616.43	\$690.16
117	154.01	193.38	245.95	364.82	524.03	621.81	696.10
118	154.89	195.00	247.87	369.00	528.35	626.94	701.77
119	155.15	196.83	248.39	369.55	534.54	632.44	707.89
120	155.85	198.51	252.33	374.29	537.50	637.73	713.72
121	158.15	199.40	253.74	377.24	541.92	643.04	719.77
122	158.27	201.72	254.56	378.69	547.97	648.45	725.71
123	158.76	202.83	257.85	383.52	550.81	653.72	731.66
124	162.76	204.52	259.87	386.55	555.41	658.86	737.58
125	162.88	206.02	262.07	389.61	559.72	664.34	743.42
126	163.60	207.70	264.08	393.00	564.28	669.63	749.47
127	163.78	209.38	264.40	393.89	567.27	673.11	755.48
128	164.63	211.00	265.88	398.32	573.20	680.36	761.34
129	165.75	212.75	269.07	399.57	577.87	685.46	767.35
130	166.77	214.88	269.96	405.26	582.10	690.83	773.29
131	168.08	215.88	270.10	405.81	586.77	696.15	779.25
132	169.83	217.70	274.20	410.57	591.26	701.63	783.01
133	170.83	219.39	274.91	413.57	595.58	706.93	790.91
134	172.32	221.45	276.38	416.21	600.24	712.06	796.96
135	173.33	222.50	277.07	418.15	604.47	717.45	800.89
136	174.58	223.27	279.79	421.09	609.14	722.74	806.53
137	175.75	225.95	281.00	421.25	613.64	728.13	814.87
138	177.10	227.39	283.12	423.52	617.95	733.52	820.98
139	178.43	229.13	285.37	426.54	622.72	738.56	826.73
140	179.76	230.83	287.32	429.68	626.92	743.95	830.39
141	180.84	233.08	289.26	432.61	631.59	749.26	838.51
142	182.19	233.23	291.41	434.34	635.83	754.67	844.64
143	183.67	234.83	293.37	438.88	640.33	759.95	850.58
144	184.99	236.49	295.32	441.81	645.01	765.15	856.53
145	186.26	236.70	297.64	444.78	649.29	770.56	862.37
146	187.42	236.91	299.66	447.99	652.13	775.88	868.56
147	188.76	243.04	302.46	451.02	656.32	781.26	874.33
148	190.08	243.18	303.63	454.07	662.80	788.78	882.86
149	191.35	243.31	305.73	456.07	665.46	791.57	886.18
150	192.58	244.23	307.76	458.99	671.69	797.16	892.14
More Than 150 Pounds**							
Price Per Pound	\$1.28	\$1.63	\$2.05	\$3.06	\$4.48	\$5.31	\$5.95

*Visit [ups.com/holidays](https://www.ups.com/holidays) for time-in-transit changes effective during the holiday season.

**For each UPS 3 Day Select package with a weight of more than 150 pounds, multiply the weight by the price per pound.

Notes:

- For additional information, refer to page 28.
- Shipments of Hazardous Materials using UPS 3 Day Select service must be prepared in accordance with the appropriate Air Dangerous Goods requirements. Hazardous Materials contract service is available with a Scheduled Pickup.

Domestic

UPS® Ground*

Delivery typically in one to five business days to all 50 states and Puerto Rico. Refer to UPS Ground Time-in-Transit Maps at [ups.com/maps](https://www.ups.com/maps) to determine scheduled delivery. Saturday Delivery and pickup available in select areas.

Zones	2	3	4	5	6	7	8	44**	45**	46**
1 Lbs.	\$10.70	\$11.12	\$12.15	\$12.70	\$13.00	\$13.27	\$13.38	\$38.56	\$39.02	\$50.79
2	11.53	12.71	13.90	14.20	14.82	15.37	15.64	42.89	43.70	55.11
3	12.00	13.38	14.37	15.10	15.72	16.24	17.04	46.61	49.79	58.69
4	12.35	13.47	15.11	16.08	16.37	17.44	18.26	51.18	53.09	63.67
5	12.56	13.95	15.33	16.64	17.31	18.25	19.53	55.48	57.61	67.72
6	12.78	14.13	15.62	16.86	17.49	18.26	19.54	59.87	61.37	70.32
7	13.50	14.45	16.04	17.41	17.81	18.75	20.27	63.92	66.09	73.91
8	13.89	14.98	16.50	17.90	18.35	19.69	21.15	66.42	69.52	77.97
9	13.97	15.05	16.51	17.91	18.74	20.32	22.07	71.10	74.33	82.63
10	14.29	15.35	16.83	18.50	19.14	21.28	23.74	75.54	80.75	87.07
11	15.02	15.64	17.14	18.69	19.57	23.04	25.22	79.55	85.44	91.14
12	15.16	16.31	17.31	18.85	20.26	24.14	26.20	82.96	88.59	94.50
13	15.22	16.36	17.38	19.07	20.89	25.51	27.47	86.40	91.83	97.88
14	15.91	16.82	17.68	19.69	22.11	27.44	29.72	89.98	95.40	101.43
15	15.92	17.05	17.94	20.23	23.33	28.09	31.10	93.29	99.71	104.69
16	16.32	17.67	18.26	20.74	24.27	29.78	32.47	97.46	103.85	108.85
17	16.44	18.04	18.46	21.32	25.10	31.07	32.65	101.62	108.84	112.29
18	16.61	18.31	18.65	22.34	26.42	32.25	35.20	105.82	115.30	116.44
19	17.01	19.14	19.55	23.32	27.09	32.87	36.92	110.00	119.00	120.60
20	17.02	19.15	19.56	24.06	28.02	34.09	38.23	113.67	123.32	124.22
21	17.74	19.90	20.60	24.52	29.09	35.28	39.40	116.28	128.98	126.83
22	17.75	20.24	21.32	25.36	30.27	36.58	41.13	119.92	133.92	130.46
23	17.76	20.48	21.76	25.64	31.42	37.46	42.76	123.53	138.81	134.06
24	18.39	21.47	22.92	27.21	33.16	38.72	45.21	127.59	143.89	138.11
25	18.44	21.54	23.02	27.55	33.87	40.85	46.60	131.54	148.92	142.08
26	19.34	22.29	23.98	28.67	35.10	42.52	48.53	135.70	152.78	146.54
27	19.88	22.82	24.46	29.15	36.52	43.31	49.34	139.47	157.81	150.40
28	20.34	23.37	25.40	30.80	38.30	45.25	51.23	143.21	162.91	154.15
29	20.36	23.81	25.79	30.85	39.39	46.28	52.60	146.74	166.93	157.28
30	20.56	24.39	26.77	32.07	40.03	46.51	54.78	150.25	172.18	160.84
31	21.51	24.96	27.39	32.55	40.99	48.24	56.53	150.26	176.47	160.92
32	21.52	24.97	27.40	32.56	41.20	48.25	57.15	150.78	182.12	161.27
33	21.60	25.34	28.63	34.09	43.57	49.84	58.70	153.94	186.87	164.49
34	21.61	25.91	29.54	35.28	43.80	51.33	61.51	157.39	191.87	167.87
35	22.01	27.08	30.28	35.86	44.55	52.65	61.95	161.29	197.03	171.76

*Visit [ups.com/holidays](https://www.ups.com/holidays) for time-in-transit changes effective during the holiday season.

**Zone 44 is metro Alaska and Hawaii, Zone 45 is Puerto Rico, and Zone 46 is remote Alaska and Hawaii.

Notes:

– For additional information, refer to page 28.

– UPS does not accept Hazardous Materials (including but not limited to Ltd Qty and combustibles) in UPS Ground services destined to and from Alaska; Hawaii; Puerto Rico; Avalon, CA; Catalina Island, CA; Beaver Island, MI; Mackinac Island, MI (winter only); The Bass Islands, OH; Kelleys Island, OH; and San Juan Islands, WA.

Domestic UPS® Ground*

Zones	2	3	4	5	6	7	8	44**	45**	46**
36 Lbs.	\$22.35	\$27.29	\$30.76	\$37.22	\$46.42	\$54.44	\$64.38	\$164.73	\$201.71	\$175.55
37	22.84	27.65	31.23	37.76	46.63	56.20	65.01	168.51	206.83	179.40
38	23.02	28.08	32.06	38.67	47.68	56.42	66.22	172.54	211.69	183.43
39	23.97	29.17	33.42	39.95	49.58	58.64	67.58	176.26	216.62	186.85
40	23.99	29.30	33.44	40.03	49.92	58.65	67.60	180.03	221.00	190.51
41	24.53	30.54	34.40	41.39	51.94	60.46	70.50	183.14	225.76	194.01
42	24.55	30.65	35.74	41.44	52.23	61.49	70.51	186.60	230.93	197.47
43	25.00	31.10	35.80	43.63	55.07	63.72	72.43	190.40	235.40	201.27
44	25.37	31.57	36.71	44.41	55.24	65.35	73.18	193.13	239.88	205.13
45	25.39	31.58	36.72	44.43	55.40	66.98	73.69	196.85	243.52	208.88
46	26.11	31.91	37.90	45.50	56.86	67.70	75.65	200.64	249.37	212.71
47	26.14	32.63	38.51	45.83	57.67	69.02	76.87	204.48	254.11	216.52
48	26.15	32.64	38.89	47.24	58.49	70.17	78.68	207.99	258.47	220.11
49	26.16	32.65	38.97	47.26	59.37	71.59	79.14	211.55	263.33	223.72
50	26.17	32.66	38.99	47.31	59.44	71.67	79.65	215.10	263.43	227.29
51	26.23	32.67	39.09	47.40	59.75	72.04	81.66	219.68	272.29	234.11
52	26.24	32.69	39.12	47.42	59.76	72.05	81.67	220.13	272.87	234.54
53	26.25	32.76	39.13	47.70	59.77	72.06	82.47	223.46	276.94	237.90
54	26.26	32.81	39.20	47.79	59.78	72.07	82.52	226.62	280.36	241.48
55	26.27	32.85	39.21	48.02	59.85	72.08	82.60	229.67	288.84	245.12
56	26.28	32.90	39.26	48.03	59.87	72.15	82.75	232.77	289.68	248.69
57	26.76	33.03	39.32	49.47	59.92	72.21	84.31	235.98	294.93	252.54
58	26.77	33.05	39.33	49.52	59.93	72.27	84.36	239.07	299.87	256.10
59	26.84	33.07	39.61	49.53	60.26	72.43	85.71	242.70	303.92	259.91
60	27.53	34.35	40.28	51.26	61.38	72.44	86.24	246.48	307.64	263.72
61	27.54	34.45	40.61	51.31	61.39	72.45	87.27	249.52	313.13	266.89
62	28.68	36.89	41.34	52.49	62.34	73.51	88.13	253.62	323.32	271.06
63	28.69	36.90	41.74	52.50	62.77	74.12	88.14	257.78	328.79	275.32
64	29.45	36.92	42.10	52.53	63.21	74.13	88.50	262.07	329.01	279.74
65	29.78	37.55	42.11	52.62	63.74	74.31	88.52	266.35	334.74	284.18
66	29.91	38.28	42.44	53.04	63.79	74.54	89.73	270.47	340.43	288.38
67	29.92	38.33	42.45	53.08	64.29	74.90	89.78	274.58	341.67	292.65
68	30.25	39.00	45.02	54.20	65.24	76.04	89.84	278.53	350.61	296.67
69	30.89	39.38	45.35	54.62	66.20	76.10	90.98	282.57	355.71	300.82
70	30.91	39.92	45.99	56.52	66.90	76.16	90.99	288.52	360.04	304.53
71	31.11	39.99	47.14	56.82	67.46	77.43	91.18	292.96	361.01	309.95
72	32.00	40.00	48.13	57.26	68.58	80.73	91.32	297.31	361.83	314.36
73	32.20	40.40	48.14	57.68	69.23	80.78	91.33	301.67	365.65	318.83
74	33.04	40.41	48.15	58.12	70.37	80.88	91.34	304.58	388.59	319.84
75	33.97	40.45	48.16	58.19	70.39	81.70	91.35	308.02	388.63	322.13

*Visit [ups.com/holidays](https://www.ups.com/holidays) for time-in-transit changes effective during the holiday season.

**Zone 44 is metro Alaska and Hawaii, Zone 45 is Puerto Rico, and Zone 46 is remote Alaska and Hawaii.

Notes:

– For additional information, refer to page 28.

– UPS does not accept Hazardous Materials (including but not limited to Ltd Qty and combustibles) in UPS Ground services destined to and from Alaska; Hawaii; Puerto Rico; Avalon, CA; Catalina Island, CA; Beaver Island, MI; Mackinac Island, MI (winter only); the Bass Islands, OH; Kelleys Island, OH; and San Juan Islands, WA.

Domestic UPS® Ground*

Zones	2	3	4	5	6	7	8	44**	45**	46**
76 Lbs.	\$36.93	\$42.71	\$48.47	\$59.54	\$71.95	\$83.03	\$92.25	\$311.82	\$388.67	\$325.97
77	38.38	43.34	49.05	59.80	72.36	85.40	92.29	314.39	388.71	327.86
78	38.43	44.97	50.50	60.44	72.81	86.03	92.30	316.08	388.75	330.24
79	39.77	46.36	51.72	60.93	74.33	87.36	93.74	316.14	403.43	331.17
80	41.25	47.73	51.99	62.85	76.28	89.08	94.76	319.44	403.51	332.88
81	41.86	48.12	53.25	62.86	76.55	89.10	94.78	322.11	404.09	334.60
82	43.19	48.82	55.66	64.83	76.97	91.40	95.40	323.72	421.88	336.12
83	43.23	48.83	55.67	64.90	76.98	91.41	96.03	327.25	425.04	337.41
84	45.38	51.25	57.29	65.53	78.87	92.50	96.08	331.03	425.19	341.20
85	46.15	51.26	57.33	66.08	79.35	93.50	96.56	334.88	427.22	345.03
86	48.30	54.11	59.57	67.84	81.05	96.13	99.52	338.40	427.43	348.59
87	49.28	54.13	59.58	67.85	82.12	96.22	99.68	342.21	433.46	352.36
88	50.85	54.82	60.99	69.51	82.42	96.32	100.77	345.99	440.18	356.18
89	53.63	56.89	62.66	70.27	84.21	97.31	102.88	349.61	440.58	359.78
90	56.87	59.35	65.32	72.34	85.41	99.56	105.90	353.13	447.15	364.67
91	56.88	59.36	65.33	72.40	85.48	99.57	105.91	356.91	447.54	366.99
92	58.15	59.86	65.67	72.96	86.35	99.58	105.96	360.32	451.48	370.43
93	58.94	60.50	66.98	73.10	86.53	99.59	106.23	363.82	451.61	373.97
94	59.24	62.08	67.30	74.05	88.62	99.61	107.32	367.26	466.88	377.45
95	60.05	62.64	67.74	75.05	88.63	99.96	108.48	370.83	466.97	380.99
96	61.38	63.06	70.23	75.31	88.64	99.97	109.55	374.22	469.18	384.33
97	64.01	65.52	71.25	77.04	91.31	101.40	112.77	377.79	469.58	387.89
98	64.86	65.95	71.26	77.94	92.35	101.41	112.78	381.14	469.79	391.34
99	65.65	65.96	72.71	78.33	92.36	102.43	112.85	384.71	470.15	394.84
100	66.16	66.82	72.72	78.81	92.77	102.50	112.92	388.28	505.38	398.43
101	67.96	68.11	73.97	80.16	93.65	103.47	115.09	388.29	510.43	398.44
102	67.97	68.12	73.98	80.17	93.66	103.48	115.14	388.30	515.48	398.50
103	68.20	69.15	75.51	80.18	93.90	103.57	115.15	388.31	520.54	398.55
104	68.21	69.16	75.52	80.19	93.91	103.58	115.16	388.35	525.59	399.80
105	71.32	71.88	77.30	83.19	96.23	106.77	117.81	391.81	530.64	399.85
106	71.82	72.26	77.43	83.20	96.24	106.78	117.82	395.44	535.68	403.32
107	72.52	72.89	78.49	83.46	96.25	106.79	117.83	399.09	540.76	406.95
108	72.53	72.99	78.50	83.47	97.11	106.80	117.84	402.73	545.81	411.52
109	75.36	75.46	80.08	85.72	97.95	108.71	119.98	406.18	550.86	415.00
110	76.74	77.27	81.77	87.22	100.67	111.53	123.34	409.60	555.91	417.39
111	76.75	77.38	83.57	87.56	100.68	111.54	123.65	414.27	560.97	423.11
112	76.91	78.23	83.58	87.57	101.48	111.55	123.66	418.95	566.03	428.86
113	76.92	78.24	84.51	88.38	101.49	111.56	124.73	422.57	571.06	432.48
114	78.47	79.92	85.62	90.10	104.18	114.35	127.90	426.25	576.11	436.16
115	80.03	82.35	87.04	91.71	105.04	116.30	129.78	429.88	581.19	439.81

*Visit [ups.com/holidays](https://www.ups.com/holidays) for time-in-transit changes effective during the holiday season.

**Zone 44 is metro Alaska and Hawaii, Zone 45 is Puerto Rico, and Zone 46 is remote Alaska and Hawaii.

Notes:

– For additional information, refer to page 28.

– UPS does not accept Hazardous Materials (including but not limited to Ltd Qty and combustibles) in UPS Ground services destined to and from Alaska; Hawaii; Puerto Rico; Avalon, CA; Catalina Island, CA; Beaver Island, MI; Mackinac Island, MI (winter only); the Bass Islands, OH; Kelleys Island, OH; and San Juan Islands, WA.

Domestic

UPS® Ground*

Zones	2	3	4	5	6	7	8	44**	45**	46**
116 Lbs.	\$80.89	\$82.62	\$88.17	\$92.12	\$105.52	\$117.97	\$129.83	\$432.57	\$586.25	\$443.32
117	80.96	82.69	88.18	93.13	105.73	117.98	130.79	436.01	591.28	447.83
118	82.59	83.66	88.28	93.40	107.50	117.99	131.54	439.45	596.35	450.21
119	84.10	84.50	90.90	94.55	107.51	118.93	131.62	445.81	601.41	458.91
120	85.67	85.79	90.91	94.75	108.37	119.37	131.81	449.47	606.43	463.70
121	85.71	85.80	90.92	94.77	109.07	119.38	131.82	452.47	611.50	466.54
122	86.55	88.28	91.92	96.34	110.77	122.40	135.39	460.60	616.57	474.81
123	87.17	89.14	95.57	98.03	110.78	123.26	135.70	463.22	621.62	479.48
124	87.27	89.24	95.67	98.04	111.29	123.27	135.97	464.02	626.66	479.53
125	87.35	89.25	95.68	98.24	111.51	123.28	135.98	467.90	631.72	482.08
126	89.95	90.13	96.66	98.25	112.18	123.52	140.50	470.80	636.78	487.10
127	89.96	91.69	98.53	100.29	115.33	125.51	140.51	474.63	641.83	489.83
128	90.75	91.70	98.54	101.18	115.56	125.76	142.87	478.49	646.88	494.88
129	91.65	91.99	98.55	101.19	115.57	125.77	142.92	482.35	651.92	498.84
130	91.91	92.02	98.72	101.20	115.58	127.41	146.18	495.57	656.99	512.40
131	93.33	94.35	101.68	103.52	117.28	128.37	146.56	495.58	662.05	514.61
132	94.27	94.39	101.69	103.53	117.29	128.38	146.57	500.03	667.09	520.42
133	94.28	96.34	101.70	103.54	117.90	128.63	146.58	503.03	672.15	522.19
134	95.87	97.00	103.30	105.99	120.82	131.72	147.97	503.05	677.21	522.24
135	97.70	98.99	105.26	107.88	121.41	132.66	148.27	506.86	682.27	527.26
136	98.42	99.23	106.97	108.81	122.32	134.38	149.72	510.71	687.32	531.19
137	98.43	99.24	108.78	109.82	124.65	134.60	150.02	524.42	692.36	545.38
138	100.26	101.76	109.31	109.91	124.66	134.61	152.70	527.21	697.41	548.23
139	101.08	101.77	109.32	109.92	124.67	136.85	153.86	527.22	702.46	548.29
140	101.99	102.78	109.58	111.42	125.02	136.86	153.88	527.23	707.53	549.11
141	102.98	103.77	111.38	112.50	126.44	138.43	155.32	528.58	712.57	549.18
142	104.30	104.31	112.37	113.39	126.90	140.35	155.91	537.40	717.64	559.58
143	104.31	104.32	112.38	114.31	127.15	140.36	156.01	541.04	722.69	563.31
144	107.16	108.70	116.53	117.65	130.28	143.71	160.27	544.75	727.75	567.09
145	107.17	109.69	116.54	117.90	132.23	144.04	160.28	544.76	732.80	567.15
146	107.18	110.41	116.69	117.91	132.24	144.05	160.30	547.29	737.85	569.63
147	107.45	110.45	117.62	117.97	133.19	144.06	162.28	560.33	742.90	583.13
148	107.55	110.46	118.35	119.87	133.63	144.08	162.30	560.34	747.96	585.81
149	107.56	110.47	118.36	120.74	133.64	144.09	162.31	561.53	753.02	585.86
150	107.57	110.50	118.60	121.77	133.90	144.37	162.63	565.38	758.07	595.19
More Than 150 Pounds***										
Price Per Pound	\$0.72	\$0.74	\$0.80	\$0.82	\$0.90	\$0.97	\$1.10	\$3.81	\$5.10	\$4.01

*Visit [ups.com/holidays](https://www.ups.com/holidays) for time-in-transit changes effective during the holiday season.

**Zone 44 is metro Alaska and Hawaii, Zone 45 is Puerto Rico, and Zone 46 is remote Alaska and Hawaii.

***For each UPS Ground package with a weight of more than 150 pounds, multiply the weight by the price per pound.

Notes:

- For additional information, refer to page 28.
- UPS does not accept Hazardous Materials (including but not limited to Ltd Qty and combustibles) in UPS Ground services destined to and from Alaska; Hawaii; Puerto Rico; Avalon, CA; Catalina Island, CA; Beaver Island, MI; Mackinac Island, MI (winter only); the Bass Islands, OH; Kelleys Island, OH; and San Juan Islands, WA.

Domestic UPS® Simple Rate

Notes:

- Size limits indicated by a box manufacturer may not reflect exterior dimensions of a package and should not be used as a substitute for actual length, width and height measurements in determining cubic inches.
- Packaging must meet all standard UPS packaging guidelines. Refer to page 19 for applicable information on measuring the length, width and height of irregularly shaped packages and items shipped in bags.
- UPS Simple Rate is limited to single-piece, prepaid, small package shipments. UPS Returns® Service options for UPS Simple Rate are limited to UPS Print Return Label Service only.
- UPS Simple Rate is not available for use with UPS Hundredweight Service®, Hazardous Materials shipments, third-party payer or freight collect shipments.
- UPS Express® packaging can be used with UPS Simple Rate for UPS Next Day Air Saver and UPS 2nd Day Air shipments.

Preparing a UPS Simple Rate Shipment

UPS Simple Rate offers flat rate pricing between the U.S. 50 states. The applicable rate is determined by package size and service option. Certain standard surcharges do not apply. Separate UPS Simple Rate pricing applies to shipments originating in or destined to Alaska and Hawaii.

Maximum Weight and Size

The maximum actual weight per UPS Simple Rate package is 50 pounds. The maximum size per UPS Simple Rate package is 1,728 cubic inches.

Service Options

Choose from four service options: UPS Next Day Air Saver®, UPS 2nd Day Air®, UPS 3 Day Select® and UPS® Ground. UPS 3 Day Select and UPS Next Day Air Saver are not available for UPS Simple Rate shipments destined to Alaska and Hawaii.

Determining the UPS Simple Rate Package Size

Follow the steps below to determine the package's UPS Simple Rate size.

1. Package the item in a box or poly mailer.

UPS Simple Rate is designed to be used with the shipper's own box or poly mailer.

2. Measure the package dimensions in inches.

For each dimension, measure at the longest point, rounding each measurement to the nearest whole number (for example, 1.00 to 1.49 will be considered 1, and 1.50 to 1.99 will be considered 2). The minimum measurement for each dimension is 1 inch.

3. Calculate the package size in cubic inches.

Multiply the package length (longest side of the package) by the width by the height. The result is the size in cubic inches.

4. Determine the package's UPS Simple Rate size.

Determine the UPS Simple Rate size, according to the package's size in cubic inches, using the chart below.

Shipping a UPS Simple Rate Package

Prepare and process UPS Simple Rate shipments at ups.com/simplerate or through another UPS automated shipping system, where available. Shippers do not need to open an account or enter into a contract to use UPS Simple Rate.

Pickup and Drop-off Availability

All standard pickup and drop-off options are available for use with UPS Simple Rate shipments. Refer to pages 25-26 for details.

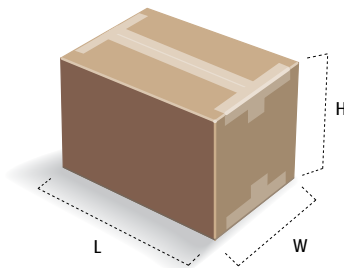

Length (L) x Width (W) x Height (H) = Cubic Inches

Cubic Inches	UPS Simple Rate Size
1-100	Extra Small
101-250	Small
251-650	Medium
651-1,050	Large
1,051-1,728	Extra Large

Domestic

UPS® Simple Rate

To determine the rate for a UPS Simple Rate shipment, refer to the applicable chart below:

UPS Simple Rate for Shipments Between the 48 Contiguous States

UPS Simple Rate Size	UPS® Ground	UPS 3 Day Select®	UPS 2nd Day Air®	UPS Next Day Air Saver®
Extra Small	\$10.85	\$18.65	\$21.55	\$31.35
Small	14.15	23.20	25.65	39.90
Medium	16.90	31.85	32.85	44.75
Large	22.30	44.10	58.60	67.15
Extra Large	27.60	55.25	75.95	86.70

UPS Simple Rate for Shipments from the 48 Contiguous States to Metro Alaska and Hawaii

UPS Simple Rate Size	UPS Ground	UPS 2nd Day Air
Extra Small	\$37.40	\$43.15
Small	40.30	46.10
Medium	49.80	56.40
Large	64.75	72.35
Extra Large	80.10	88.20



UPS Simple Rate for Shipments from the 48 Contiguous States to Remote Alaska and Hawaii

UPS Simple Rate Size	UPS Ground	UPS 2nd Day Air
Extra Small	\$49.20	\$79.50
Small	51.75	85.90
Medium	61.80	96.80
Large	75.80	112.55
Extra Large	92.45	133.60

Common Box Dimensions by UPS Simple Rate Size

UPS Simple Rate Size	Extra Small	Small	Medium	Large	Extra Large
Cubic Inch Range	1-100	101-250	251-650	651-1,050	1,051-1,728
Common Box Dimensions	8 x 6 x 2 6 x 4 x 4 11 x 9 x 1 4 x 4 x 4	8 x 6 x 5 12 x 9 x 2 9 x 7 x 3 6 x 6 x 6	13 x 11 x 2 12 x 9 x 6 13 x 12 x 4 8 x 8 x 8	12 x 12 x 7 15 x 11 x 6 14 x 10 x 7 10 x 10 x 10	16 x 12 x 9 12 x 10 x 9 18 x 12 x 6 12 x 12 x 12

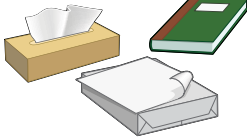
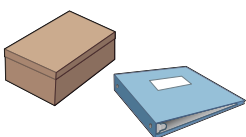
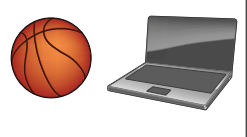
Example Products by UPS Simple Rate Size

Extra Small	Small	Medium	Large	Extra Large
1-100 Cubic Inches	101-250	251-650	651-1,050	1,051-1,728
 Accessories Small Electronics T-shirt / Coffee Mug	 Hardcover Book Tissue Box Ream of Paper	 Shoebbox Three-Inch Three-Ring Binder	 Regulation Basketball 14-Inch Laptop	 Small Appliances Tennis Racket

Notes:

- The following surcharges do not apply to UPS Simple Rate shipments: Residential Surcharge, Delivery Area Surcharge, Delivery Area Surcharge Extended and fuel surcharges. Fees for other charges and value-added services set forth on pages 114-130 apply to UPS Simple Rate shipments.
- To determine which ZIP codes are included in metro Alaska and Hawaii and remote Alaska and Hawaii, enter your origin ZIP code and download a zone chart at: [ups.com/dailyratezones](https://www.ups.com/dailyratezones).
- The common box dimensions and example products listed below are provided by way of example only. All UPS Simple Rate shipments must conform to the terms, conditions, restrictions and prohibitions applicable to UPS Simple Rate.

Originating Within the U.S. 48 Contiguous States

Air Freight

Weight Breaks (Lbs.)	Destination U.S. 48							Destination			Destination Canada			
								AK/HI Metro	PR	AK/HI Extended				

UPS Next Day Air® Freight

Guaranteed next-business-day delivery by 12:00 p.m. or 5:00 p.m., depending on destination, to most major metropolitan areas within and between the 48 contiguous states, Puerto Rico and Canada (excluding intra-Canada). For UPS zone information, refer to the 48 Contiguous States Zone Charts at [ups.com/dailyratezones](https://www.ups.com/dailyratezones) for UPS Next Day Air® service.

For UPS zone information, refer to pages 35-39 for UPS Worldwide Express® service.

Zones	102	103	104	105	106	107	108		125		81	82
151-499 Lbs.	\$1.67	\$2.74	\$4.97	\$6.92	\$7.23	\$9.25	\$10.06	For Next Business Day Service to AK/HI Metro, UPS Next Day Air® Freight NGS is available.	\$8.31	For Next Business Day Service to AK/HI Extended, UPS Next Day Air Freight NGS is available.	\$7.13	\$7.56
500-999	1.63	2.58	4.38	6.84	6.94	8.96	8.88		8.27		7.10	7.54
1,000-1,999	1.50	2.54	4.06	6.39	6.86	8.68	9.50		7.76		6.65	7.08
2,000 or More	1.42	2.39	3.66	5.45	6.65	8.08	9.43		7.74		6.63	7.06
Minimum Charge	172.19	286.12	430.60	542.05	576.45	601.20	671.38		1,249.00		715.51	783.76

UPS 2nd Day Air® Freight

Guaranteed delivery by 12:00 p.m. or 5:00 p.m. on the second business day, depending on destination, to most major metropolitan areas within and between the 48 contiguous states, Puerto Rico and Canada (excluding intra-Canada). For UPS zone information, refer to the 48 Contiguous States Zone Charts at [ups.com/dailyratezones](https://www.ups.com/dailyratezones) for UPS 2nd Day Air® service.

For UPS zone information, refer to pages 35-39 for UPS Worldwide Expedited® service.

Zones	202	203	204	205	206	207	208		225		71	72
151-499 Lbs.	\$1.62	\$2.65	\$3.47	\$3.63	\$5.40	\$7.22	\$8.48	For Second Business Day Service to AK/HI Metro, UPS 2nd Day Air Freight NGS is available.	\$5.91	For Second Business Day Service to AK/HI Extended, UPS 2nd Day Air Freight NGS is available.	\$5.09	\$5.32
500-999	1.57	2.57	3.27	3.55	5.24	6.97	7.97		5.87		5.06	5.31
1,000-1,999	1.46	2.46	3.11	3.50	5.08	6.88	7.71		5.48		4.70	4.93
2,000 or More	1.39	2.35	3.08	3.22	4.57	5.96	6.94		5.46		4.67	4.92
Minimum Charge	165.91	269.10	333.30	407.19	458.83	549.42	594.12		823.14		550.92	583.04

UPS 3 Day Freight®

Guaranteed day-definite delivery within three to four business days by 5:00 p.m. to most major metropolitan areas within and between the 48 contiguous states and Canada. For UPS zone information, refer to the 48 Contiguous States Zone Charts at [ups.com/dailyratezones](https://www.ups.com/dailyratezones) for UPS 3 Day Select® service.

For UPS zone information, refer to pages 35-39 for UPS® Standard to Canada.

Zones	302	303	304	305	306	307	308				51	52	53	54	55	56
151-499 Lbs.	\$1.56	\$2.57	\$3.30	\$3.60	\$5.14	\$6.44	\$7.45	For Service to AK/HI Metro, UPS Next Day Air Freight NGS and UPS 2nd Day Air Freight NGS are available.	For Service to AK/HI Extended, UPS Next Day Air Freight NGS and UPS 2nd Day Air Freight NGS are available.		\$2.27	\$2.90	\$3.38	\$4.15	\$4.61	\$5.08
500-999	1.41	2.52	3.25	3.50	4.79	6.28	7.31			2.23	2.84	3.33	4.04	4.47	4.96	
1,000-1,999	1.37	2.35	3.01	3.41	4.67	5.90	7.19			2.16	2.72	3.23	3.95	4.31	4.78	
2,000 or More	1.24	2.30	2.98	3.13	4.43	5.85	6.79			2.10	2.62	3.07	3.76	4.18	4.61	
Minimum Charge	161.94	163.19	193.44	206.10	233.45	266.41	300.32			299.31	382.39	449.52	549.30	605.10	670.97	

For guarantee details, service availability, delivery time commitments, to request a pickup or to view the "UPS Air Freight Terms and Conditions of Contract for UPS Air Freight Services in the United States, Canada and International," visit UPS Supply Chain Solutions at [ups.com/freighttermsofservice](https://www.ups.com/freighttermsofservice).

Notes:

- Door-to-door delivery for shipments of more than 150 pounds.
- All of the rates above are per pound and minimum charges are per shipment unless otherwise specified.
- A.M., P.M., B1, B2 and B3 points are defined by the current version of UPS Supply Chain Solutions® Quick Zip program, available at [Quick Zip](https://www.ups.com/supplychainsolutions) at [ups.com/supplychainsolutions](https://www.ups.com/supplychainsolutions). UPS Supply Chain Solutions service points are subject to change without prior notice.

Originating Within the U.S. 48 Contiguous States Air Freight

Weight Breaks (Lbs.)	Destination U.S. 48					Destination			Destination Canada			
						AK/HI Metro	PR	AK/HI Extended				

UPS Next Day Air® Freight NGS												
Delivery the next business day by 12:00 p.m. or 5:00 p.m., depending on destination, to most areas within and between all 50 states, Puerto Rico and Canada. For UPS zone information, refer to the 48 Contiguous States Zone Charts at ups.com/dailyratezones for UPS Next Day Air® service.											For UPS zone information, refer to pages 35-39 for UPS Worldwide Express® service.	
Zones	102	103	104	105	106	107	108	124	125	126	81	82
151-499 Lbs.	\$1.61	\$2.61	\$4.69	\$6.53	\$6.84	\$8.76	\$9.53	\$10.48	\$7.85	\$11.00	\$6.74	\$7.16
500-999	1.55	2.46	4.15	6.50	6.51	8.49	9.35	10.16	7.81	10.62	6.70	7.13
1,000-1,999	1.46	2.38	4.00	6.28	6.49	8.23	8.99	9.76	7.33	10.56	6.29	6.70
2,000 or More	1.38	2.27	3.59	5.34	6.42	7.63	8.90	9.64	7.28	10.36	6.25	6.67
Minimum Charge	173.18	270.52	407.12	512.47	544.99	568.39	634.75	1,198.59	1,180.85	1,313.08	676.47	741.00

UPS 2nd Day Air® Freight NGS												
Delivery by 12:00 p.m. or 5:00 p.m. on the second business day, depending on destination, to major areas within and between the 50 states, Puerto Rico and Canada. For UPS zone information, refer to the 48 Contiguous States Zone Charts at ups.com/dailyratezones for UPS 2nd Day Air® service.											For UPS zone information, refer to pages 35-39 for UPS Worldwide Expedited® service.	
Zones	202	203	204	205	206	207	208	224	225	226	71	72
151-499 Lbs.	\$1.52	\$2.56	\$3.22	\$3.46	\$5.04	\$6.77	\$7.95	\$9.03	\$5.84	\$9.68	\$4.79	\$5.01
500-999	1.47	2.40	3.04	3.31	4.90	6.52	7.46	8.92	5.81	9.48	4.76	4.99
1,000-1,999	1.35	2.35	2.90	3.26	4.74	6.45	7.22	8.49	5.42	9.34	4.44	4.64
2,000 or More	1.30	2.18	2.87	3.03	4.26	5.60	6.42	8.12	5.39	9.30	4.40	4.62
Minimum Charge	156.26	253.42	313.89	383.48	432.11	517.45	559.54	1,036.55	775.26	1,098.01	518.87	549.12

UPS 3 Day Freight® NGS																	
Day-definite delivery within three to four business days by 5:00 p.m. to most areas within and between the 48 contiguous states and Canada. For UPS zone information, refer to the 48 Contiguous States Zone Charts at ups.com/dailyratezones for UPS 3 Day Select® service.													For UPS zone information, refer to pages 35-39 for UPS® Standard to Canada.				
Zones	302	303	304	305	306	307	308					51	52	53	54	55	56
151-499 Lbs.	\$1.45	\$2.53	\$3.11	\$3.37	\$4.86	\$6.07	\$7.03	For Service to AK and HI, UPS Next Day Air Freight NGS and UPS 2nd Day Air Freight NGS are available.				\$2.14	\$2.76	\$3.19	\$3.95	\$4.36	\$4.83
500-999	1.30	2.35	3.00	3.29	4.53	5.94	6.91					2.12	2.72	3.17	3.85	4.25	4.71
1,000-1,999	1.25	2.21	2.81	3.20	4.41	5.57	6.78					2.05	2.57	3.07	3.75	4.11	4.54
2,000 or More	1.19	2.14	2.80	2.82	4.17	5.51	6.39					1.99	2.50	2.92	3.58	3.97	4.36
Minimum Charge	153.37	154.56	183.22	195.22	221.13	252.35	284.46					283.49	362.19	425.79	520.28	573.14	635.54

For service availability, delivery time commitments, to request a pickup or to view the "UPS Air Freight Terms and Conditions of Contract for UPS Air Freight Services in the United States, Canada and International," visit UPS Supply Chain Solutions at [ups.com/freighttermsofservice](https://www.ups.com/freighttermsofservice).

Notes:

- Door-to-door delivery for shipments of more than 150 pounds.
- All of the rates above are per pound and minimum charges are per shipment unless otherwise specified.
- A.M., P.M., B1, B2 and B3 points are defined by the current version of UPS Supply Chain Solutions® Quick Zip program, available at [Quick Zip](https://www.ups.com/supplychainsolutions) at [ups.com/supplychainsolutions](https://www.ups.com/supplychainsolutions). UPS Supply Chain Solutions service points are subject to change without prior notice.

Determining the Rate

Export Shipment Pricing

UPS Worldwide Express Plus®, UPS Worldwide Express®, UPS Worldwide Express Freight® Midday, UPS Worldwide Express Freight®, UPS Worldwide Saver®, UPS Worldwide Expedited® and UPS® Standard

Shipment pricing is advantageous because rates are based on the total weight of a shipment, not the sum of the rates for each package in a shipment.

What Qualifies

1. The shipment consists of multiple packages, using the same service, shipped on the same day to a single consignee.
2. For shipments processed with WorldShip® or UPS CampusShip® shipping systems, ups.com shipping, the UPS® Developer Kit or a UPS Ready® solution that supports full international service, or a UPS Worldwide Services Waybill. **Note:** For shipments processed with UPS Developer Kit – Shipping API, in order to obtain the best rate, customers are responsible for aggregating shipments for shipment pricing prior to requesting labels (UPS Developer Kit – Shipping API does not run End of Day).

What Does Not Qualify

Shipment pricing does not apply to UPS Express® Envelopes, UPS Express® Paks, the UPS® 10 KG Box, the UPS® 25 KG Box or packages recorded in a UPS Shipping Record book; they are each considered separate shipments.

Rates

Rates are based on the total billable weight of all packages in the shipment. Compare each package's actual weight to its dimensional weight. The greater of the two is the billable weight and should be used to calculate the rate. For multiple-package shipments, total the billable weight of all packages in the shipment. Refer to pages 18-19 for instructions on calculating dimensional and billable weight.

If the payer of the shipping charges is located in the origin country, the shipment will be charged the export rate (Origin Country Export Rates). When the payer of the shipping charges is located in the destination country,

the shipment will be charged the import rate (Destination Country Import Rates). If the destination country does not have import rates, the shipment will be charged the export rate (Origin Country Export Rates). When the payer of the shipping charges is located in a third country (neither origin nor destination country), the shipment will be charged the Origin Country Export Rates, except as otherwise agreed to by UPS and the contracting party.

For shipments weighing 150 pounds or less, locate the rate for the total weight of the shipment on the appropriate rate chart.

For shipments weighing more than 150 pounds, multiply the total weight (rounded to the next whole pound) by the appropriate price per pound. The amount billed will be the result of this calculation or the minimum rate shown, whichever is greater.

For a multiple-package UPS Standard shipment, the minimum charge will be based on an average weight of 15 pounds per package.

Customs Brokerage

For UPS Worldwide Express Plus, UPS Worldwide Express, UPS Worldwide

Express Freight Midday, UPS Worldwide Express Freight, UPS Worldwide Saver, UPS Worldwide Expedited and UPS® Standard to Mexico, rates include routine, in-house customs clearance by UPS Supply Chain Solutions. Additional charges will apply if customs clearance is performed by customs brokerage offices other than those designated by UPS for clearing the services listed above.

Customs clearance for the services listed is provided by the UPS Supply Chain Solutions customs brokerage offices designated by UPS for handling package customs clearance. Other UPS Supply Chain Solutions customs brokerage offices charge fees for clearance of packages and freight.

For UPS® Standard to Canada, charges for customs clearance are not included in the rate. UPS will provide Customs Brokerage Services, unless otherwise specified by the importer. Customs brokerage charges, duties and taxes will be billed to the importer, unless otherwise indicated by the shipper. Canada brokerage rates are available at [ups.com/cacustomsclearance](https://www.ups.com/cacustomsclearance).

Useful Information – International Shipping

Import/Export Support

Information on international shipping and trade

Visit [ups.com/international](https://www.ups.com/international)

Shipping Forms

Import/export documents

Visit [ups.com/intl_forms](https://www.ups.com/intl_forms)

UPS Paperless® Invoice

Send Commercial Invoices and other customs documents electronically, saving time and paper

Visit [International Tools and Resources](https://www.ups.com/international_tools_and_resources)

UPS TradeAbility® Services

Harmonizer, landed cost and compliance tools

Visit [UPS TradeAbility Services](https://www.ups.com/tradeability_services)

International Customer Service

Assistance with international shipments

Call 1-800-782-7892

Export

UPS Worldwide Express®

UPS Worldwide Express Plus®

Guaranteed delivery by 8:30 a.m., 9:00 a.m. or 11:00 a.m. to major cities in over 55 countries and territories. Delivery is guaranteed on the next business day to Canada, on the second business day to Europe and Latin America, and on the second or third business day to Asia. Rates include door-to-door delivery with routine, in-house customs clearance by UPS Supply Chain Solutions®. Add \$40.00 to the appropriate UPS Worldwide Express rate for each UPS Worldwide Express Plus shipment.

UPS Worldwide Express

Guaranteed delivery by 10:30 a.m., 12:00 p.m. or 2:00 p.m. to over 130 countries and territories. Delivery guaranteed on the next business day to Canada and for documents to Mexico, the second business day to Europe and Latin America, and the second or third business day to Asia. Rates include door-to-door delivery with routine, in-house customs clearance by UPS Supply Chain Solutions.

Zones	81	82	84	901	902	903	904	905	906	907	908	909	911	912	913	920	921
Letter*	\$56.25	\$61.90	\$64.55	\$82.00	\$70.49	\$85.40	\$103.28	\$94.55	\$122.80	\$164.84	\$182.80	\$80.35	\$96.23	\$88.70	\$75.78	\$67.62	\$81.27
Pak 1 Lb.**	93.90	104.27	86.43	111.44	92.93	119.33	139.06	123.43	137.97	187.81	185.05	106.04	125.33	119.30	101.23	89.14	99.97
Pak 2 Lbs.**	103.28	115.08	90.74	117.81	103.89	122.92	151.38	135.80	185.11	223.26	216.24	116.43	145.90	134.30	111.96	99.66	133.90
10 KG Box†	191.28	229.15	236.71	287.26	274.06	320.56	390.32	336.22	529.32	450.93	488.23	293.87	353.17	333.05	292.05	247.26	404.43
25 KG Box†	308.73	361.58	373.74	437.56	413.48	493.89	660.70	598.89	881.85	870.46	817.56	456.72	554.95	551.17	454.46	406.86	697.41
1 Lbs.	116.56	129.48	117.61	142.10	130.19	165.14	154.63	153.84	185.80	229.14	242.83	135.33	167.40	150.30	129.06	118.88	122.99
2	123.54	140.20	130.97	151.64	131.07	187.56	191.33	172.79	217.86	244.95	260.55	146.19	183.98	171.61	149.91	127.92	152.36
3	137.77	153.08	145.68	175.76	143.63	209.09	219.77	199.68	254.86	295.25	295.43	173.11	205.22	192.96	171.81	140.19	163.91
4	151.73	168.28	163.74	200.40	163.36	231.78	254.81	229.53	306.10	338.29	334.86	198.87	225.59	218.49	200.04	156.40	184.90
5	161.67	199.31	186.60	233.82	184.25	251.17	287.39	272.84	330.29	382.52	375.77	238.96	269.70	264.99	255.34	176.40	206.71
6	173.54	207.94	208.66	249.90	205.79	270.13	311.17	292.74	374.78	397.01	419.26	254.73	302.85	289.35	272.27	191.54	240.70
7	178.00	211.96	222.78	264.28	220.32	296.13	338.70	318.66	416.32	426.97	446.12	263.85	327.21	311.08	286.99	205.07	267.16
8	181.77	219.02	231.69	275.86	233.07	313.86	364.79	336.49	495.61	443.35	477.66	273.06	347.31	325.75	287.28	216.94	292.37
9	182.20	221.62	233.44	277.13	234.95	314.32	371.38	338.58	503.47	445.73	495.97	274.27	350.72	328.75	288.72	218.69	326.35
10	185.07	225.11	237.11	285.57	240.34	319.34	382.88	339.89	507.11	447.61	505.80	279.52	352.38	330.59	289.69	223.71	342.68
11	188.07	225.16	238.24	286.21	251.90	321.69	382.93	345.44	529.64	459.29	506.05	290.57	352.90	340.53	293.47	234.49	360.54
12	190.28	233.74	247.23	295.40	261.76	325.54	385.41	354.55	533.51	473.54	510.90	300.44	367.59	344.13	298.87	243.64	386.50
13	228.48	273.14	299.60	336.77	274.97	387.08	477.03	425.88	644.07	564.75	626.85	362.52	417.99	427.31	373.35	255.94	403.72
14	248.15	287.09	331.48	382.43	287.21	426.82	540.17	487.94	712.41	640.67	697.08	394.67	529.15	479.50	398.99	267.33	420.09
15	257.77	296.76	354.78	395.60	318.78	453.05	577.04	542.21	749.42	694.55	705.88	408.99	539.66	503.06	421.06	296.73	444.33
16	270.40	318.28	357.11	413.42	339.11	476.66	597.47	553.86	838.25	783.95	766.14	433.41	558.11	534.27	436.90	315.64	465.51
17	278.17	327.60	358.45	422.07	341.45	478.56	615.11	555.07	844.96	793.53	817.43	447.98	563.29	548.79	439.31	317.82	482.87
18	283.90	328.94	359.81	423.23	343.57	479.84	616.83	556.29	874.55	817.63	836.66	451.66	564.49	550.12	440.62	319.80	494.47
19	285.14	332.31	361.17	424.38	366.46	481.04	618.17	557.50	886.26	860.88	838.94	453.01	565.72	551.48	441.95	341.10	515.61
20	286.37	333.65	362.52	425.54	380.10	482.26	619.46	558.72	888.02	870.78	843.06	454.38	566.93	555.37	443.29	353.79	532.19
21	288.94	344.48	363.82	428.73	384.39	483.35	631.54	559.91	889.34	880.44	844.18	455.62	568.14	560.26	443.42	357.80	540.14
22	290.18	345.83	364.97	429.84	385.74	484.43	632.86	561.13	890.66	881.64	845.30	456.89	569.35	561.79	445.67	359.05	556.10
23	294.16	347.17	366.14	430.97	392.44	485.53	634.18	562.35	891.98	883.27	854.59	458.16	570.56	563.13	457.28	365.29	568.47
24	302.44	349.25	370.62	437.32	394.26	492.24	638.95	592.38	919.84	884.36	885.44	464.65	585.65	567.10	459.00	366.98	585.41
25	303.59	352.29	375.48	441.49	402.77	508.05	647.27	603.57	931.85	886.59	909.10	475.26	594.88	581.61	464.40	374.90	604.13

*The Letter rate applies only to documents, correspondence and electronic media shipments of no commercial value that do not exceed eight ounces sent in a UPS Express® Envelope.

**UPS Express® Pak rates apply to shipments weighing two pounds or less, with a customs value of less than \$100.00 and UPS Express Pak selected at the time of shipping.

† Shipments exceeding the maximum weights (10 KG/22 pounds and 25 KG/55 pounds) will be charged the regular UPS Worldwide Express Plus or UPS Worldwide Express rate. Available only when the shipper is paying the shipping charges.

Note: For additional information, refer to page 28.

Export

UPS Worldwide Express[®]

Zones	81	82	84	901	902	903	904	905	906	907	908	909	911	912	913	920	921
26 Lbs.	\$358.57	\$428.15	\$433.92	\$569.43	\$436.68	\$658.97	\$803.50	\$684.13	\$1,100.29	\$1,104.34	\$983.98	\$594.09	\$758.36	\$729.68	\$566.57	\$406.45	\$623.87
27	381.83	442.82	485.30	611.84	445.63	684.14	855.32	769.23	1,184.44	1,251.41	1,253.78	627.27	838.01	774.55	627.04	414.80	632.12
28	395.16	464.96	509.41	629.43	447.02	693.36	880.76	774.57	1,192.86	1,308.42	1,297.52	645.66	846.06	788.68	641.15	416.07	648.11
29	398.75	470.45	511.86	641.16	448.41	710.57	905.97	839.69	1,246.52	1,341.63	1,313.19	647.17	848.63	826.70	642.36	417.38	664.06
30	398.80	476.95	513.20	654.63	458.82	728.52	909.57	860.33	1,256.31	1,348.56	1,328.78	652.65	851.76	831.21	663.10	427.07	678.71
31	412.26	491.39	514.56	668.48	474.46	747.39	989.83	868.41	1,259.24	1,349.98	1,358.91	674.81	914.33	858.36	700.56	441.63	696.45
32	420.85	499.57	515.76	672.10	495.31	751.45	1,019.69	869.63	1,265.35	1,353.06	1,360.73	712.85	949.24	876.65	715.42	461.04	712.43
33	429.42	509.61	544.16	707.94	506.04	764.26	1,043.02	889.35	1,359.07	1,384.00	1,366.18	726.83	952.73	880.15	739.14	471.02	728.03
34	433.76	517.81	548.51	717.20	524.64	765.62	1,065.62	910.29	1,368.46	1,391.41	1,373.01	738.66	956.73	906.51	750.78	488.32	743.33
35	440.75	526.02	549.77	741.76	526.89	776.79	1,088.97	912.65	1,449.62	1,471.16	1,374.47	740.19	1,037.28	917.29	752.15	490.41	767.04
36	441.86	532.24	551.20	760.23	571.51	787.39	1,106.48	913.86	1,501.64	1,479.79	1,403.66	741.60	1,045.31	978.09	768.25	531.97	774.43
37	459.99	544.09	552.57	763.21	603.37	794.29	1,147.60	915.07	1,524.45	1,481.58	1,430.75	785.88	1,046.56	992.07	799.03	561.61	791.40
38	466.19	551.58	553.94	765.21	606.59	818.97	1,182.86	950.79	1,543.02	1,482.95	1,433.46	799.61	1,053.61	996.49	813.49	564.61	807.18
39	474.43	558.88	563.50	800.08	619.02	829.53	1,207.60	967.89	1,544.29	1,484.28	1,446.49	814.61	1,055.34	1,038.32	828.35	576.18	822.31
40	483.00	568.20	564.86	815.73	620.39	867.86	1,209.73	969.62	1,545.55	1,485.67	1,507.86	819.20	1,056.79	1,039.95	839.56	577.45	839.07
41	491.58	571.73	570.50	829.75	632.19	871.71	1,232.99	1,003.74	1,546.82	1,487.18	1,606.93	840.97	1,112.23	1,043.17	841.48	588.44	856.17
42	499.48	584.31	595.00	840.61	634.85	876.49	1,256.45	1,023.73	1,569.61	1,510.38	1,633.22	854.24	1,137.36	1,090.38	868.82	590.92	872.46
43	505.86	595.13	605.66	857.41	636.23	930.07	1,279.72	1,026.00	1,580.15	1,587.53	1,692.74	868.22	1,185.23	1,105.46	883.50	592.21	902.97
44	513.26	604.26	610.44	868.79	647.51	967.48	1,303.56	1,071.15	1,581.44	1,627.68	1,698.72	881.40	1,201.02	1,127.74	896.18	602.70	909.73
45	521.00	611.59	618.94	882.12	649.71	991.87	1,327.05	1,154.02	1,582.71	1,632.65	1,706.42	895.40	1,203.18	1,151.10	910.45	604.74	935.39
46	527.05	624.98	637.23	895.94	693.38	1,000.33	1,356.31	1,162.30	1,583.98	1,732.26	1,860.74	904.71	1,246.58	1,161.40	919.93	645.39	952.72
47	534.77	631.22	647.87	911.55	697.76	1,008.58	1,373.77	1,225.98	1,585.25	1,808.29	1,876.27	919.47	1,250.98	1,177.52	935.48	649.46	972.39
48	542.00	642.84	656.35	925.17	699.14	1,039.15	1,397.22	1,232.36	1,601.00	1,815.92	1,877.84	933.45	1,252.24	1,196.54	947.47	650.76	992.10
49	548.04	649.27	663.57	938.34	725.73	1,042.25	1,419.94	1,252.25	1,614.13	1,900.58	1,879.19	948.20	1,253.49	1,198.10	964.01	675.53	1,011.63
50	555.96	658.68	664.77	939.58	728.43	1,044.70	1,441.49	1,256.12	1,641.60	1,909.07	1,880.55	961.61	1,256.29	1,199.74	977.75	678.04	1,031.80
52	572.54	671.58	668.46	977.74	778.37	1,096.57	1,495.10	1,334.17	1,852.33	1,915.24	1,944.48	978.49	1,351.34	1,209.84	995.03	724.51	1,041.98
54	578.57	679.79	701.95	998.73	787.43	1,120.42	1,523.43	1,342.46	1,864.82	1,919.39	1,951.48	995.45	1,409.83	1,271.52	1,009.27	732.94	1,075.86
56	590.29	692.82	714.79	1,029.90	819.71	1,141.09	1,578.26	1,346.47	1,951.80	2,011.64	1,967.50	1,026.50	1,429.26	1,317.17	1,042.38	762.98	1,107.91
58	602.68	705.68	728.60	1,061.09	851.98	1,152.41	1,634.25	1,350.45	2,007.43	2,118.26	1,983.50	1,057.56	1,448.68	1,362.66	1,077.59	793.02	1,143.39
60	620.64	721.43	732.30	1,096.09	856.11	1,236.51	1,704.18	1,356.88	2,043.60	2,186.69	2,084.42	1,098.45	1,603.76	1,467.42	1,117.54	796.87	1,177.92
62	632.38	734.81	753.93	1,109.26	905.46	1,255.06	1,759.93	1,413.20	2,047.75	2,194.97	2,089.45	1,127.23	1,608.82	1,496.22	1,163.37	842.79	1,213.59
64	644.17	745.73	757.64	1,157.58	910.87	1,258.97	1,816.51	1,491.64	2,051.96	2,199.10	2,130.56	1,156.00	1,613.06	1,543.93	1,188.50	847.83	1,252.27
66	652.74	757.86	770.06	1,187.02	917.90	1,262.88	1,860.47	1,497.33	2,152.78	2,203.21	2,134.92	1,184.76	1,692.31	1,559.85	1,211.99	854.37	1,285.90
68	666.30	770.72	799.13	1,217.48	980.00	1,331.68	1,874.93	1,588.71	2,325.90	2,249.90	2,324.39	1,213.50	1,696.68	1,572.56	1,247.44	912.17	1,330.94
70	679.14	784.96	810.99	1,246.37	984.15	1,350.62	1,969.86	1,607.17	2,342.71	2,281.68	2,344.90	1,242.22	1,700.52	1,616.75	1,277.26	916.04	1,365.84

Note: For additional information, refer to page 28.

Export

UPS Worldwide Express®

Zones	81	82	84	901	902	903	904	905	906	907	908	909	911	912	913	920	921
72 Lbs.	\$705.81	\$789.43	\$815.16	\$1,321.51	\$1,021.95	\$1,443.81	\$2,049.23	\$1,698.77	\$2,368.34	\$2,288.82	\$2,401.61	\$1,251.20	\$1,770.06	\$1,657.11	\$1,288.03	\$951.24	\$1,403.49
74	735.84	796.96	818.86	1,351.09	1,026.24	1,496.50	2,088.43	1,709.52	2,375.38	2,376.64	2,459.63	1,297.41	1,813.97	1,698.41	1,303.67	955.23	1,442.26
76	755.85	809.47	822.54	1,355.02	1,101.21	1,510.37	2,097.70	1,787.30	2,545.06	2,453.84	2,463.80	1,326.12	1,864.53	1,742.24	1,363.20	1,024.99	1,477.80
78	762.78	820.01	849.36	1,393.05	1,109.06	1,515.43	2,151.39	1,791.23	2,549.48	2,464.16	2,479.83	1,354.89	1,869.67	1,848.33	1,392.95	1,032.30	1,516.18
80	771.68	830.25	857.19	1,416.22	1,115.99	1,589.57	2,170.54	1,825.52	2,577.56	2,475.47	2,502.11	1,383.58	1,873.51	1,883.75	1,425.57	1,038.76	1,542.64
82	779.68	840.45	884.36	1,455.72	1,120.12	1,593.59	2,174.75	1,829.43	2,581.50	2,479.73	2,549.08	1,387.52	1,878.66	1,901.44	1,429.93	1,042.61	1,549.60
84	786.80	850.50	893.09	1,487.07	1,196.68	1,597.59	2,279.97	1,833.32	2,585.43	2,523.65	2,552.78	1,391.47	1,978.43	1,905.23	1,440.07	1,113.85	1,587.61
86	795.50	858.02	897.50	1,510.18	1,205.07	1,601.13	2,319.18	1,867.69	2,589.37	2,595.79	2,705.44	1,458.38	1,984.93	1,908.99	1,494.19	1,121.66	1,619.33
88	804.39	873.30	901.69	1,539.44	1,209.58	1,648.28	2,358.15	1,871.58	2,593.30	2,656.47	2,805.02	1,462.07	2,104.37	1,912.77	1,519.22	1,125.87	1,655.47
90	813.29	880.98	923.27	1,550.16	1,227.54	1,716.27	2,396.98	1,973.58	2,597.25	2,660.17	2,883.43	1,500.67	2,126.36	1,916.55	1,544.40	1,142.59	1,693.63
92	829.81	890.46	934.69	1,571.43	1,253.66	1,726.74	2,436.39	2,024.76	2,601.17	2,677.60	2,891.74	1,523.15	2,130.44	1,920.32	1,569.40	1,166.90	1,731.02
94	838.80	900.37	938.38	1,604.34	1,273.29	1,841.40	2,465.94	2,135.92	2,605.12	2,840.53	2,895.96	1,550.51	2,236.17	1,924.09	1,587.60	1,185.18	1,764.74
96	845.54	907.59	942.08	1,617.34	1,309.41	1,879.86	2,492.59	2,153.37	2,609.05	3,012.18	3,043.24	1,580.70	2,250.44	1,997.07	1,619.69	1,218.79	1,795.02
98	849.42	911.60	946.14	1,621.10	1,336.84	1,883.39	2,504.65	2,157.09	2,612.99	3,113.40	3,179.20	1,584.37	2,254.28	2,009.11	1,630.90	1,244.32	1,827.09
100	861.62	919.50	950.22	1,624.98	1,419.22	1,887.47	2,508.82	2,316.09	2,796.35	3,255.52	3,457.44	1,588.46	2,258.12	2,013.26	1,645.83	1,321.00	1,833.67
105	901.25	961.50	994.42	1,701.49	1,555.68	1,985.58	2,618.09	2,431.04	2,936.17	3,418.29	3,735.71	1,722.19	2,408.92	2,120.41	1,726.65	1,393.88	1,905.62
110	944.15	1,007.28	1,041.55	1,782.51	1,629.74	2,079.03	2,742.78	2,546.80	3,075.98	3,581.06	3,913.40	1,804.19	2,523.65	2,221.38	1,807.47	1,460.24	1,920.95
115	987.09	1,053.05	1,087.94	1,863.55	1,703.82	2,173.14	2,867.44	2,662.55	3,215.79	3,743.84	4,087.43	1,886.19	2,638.37	2,322.34	1,887.99	1,526.61	1,981.70
120	1,030.00	1,098.84	1,135.18	1,944.54	1,777.89	2,267.61	2,992.13	2,778.33	3,355.59	3,906.62	4,261.07	1,968.22	2,753.07	2,423.30	1,968.34	1,593.00	2,060.82
125	1,072.90	1,144.62	1,181.30	2,025.58	1,851.97	2,361.19	3,116.78	2,894.09	3,495.43	4,069.39	4,434.41	2,050.21	2,867.78	2,524.28	2,050.11	1,659.36	2,140.48
130	1,134.87	1,190.38	1,227.63	2,106.60	1,926.07	2,526.03	3,330.65	3,009.85	3,702.55	4,232.15	4,611.61	2,193.73	2,982.47	2,625.24	2,161.62	1,725.75	2,198.27
135	1,178.49	1,236.19	1,274.62	2,187.61	2,000.13	2,622.97	3,458.77	3,125.61	3,844.96	4,394.94	4,784.61	2,278.10	3,097.19	2,726.22	2,254.52	1,792.12	2,254.29
140	1,221.96	1,281.97	1,321.76	2,268.63	2,074.22	2,717.68	3,586.86	3,241.38	3,987.38	4,557.72	4,961.65	2,362.45	3,211.91	2,827.17	2,337.96	1,858.50	2,328.24
145	1,264.59	1,327.74	1,368.90	2,395.28	2,148.30	2,813.42	3,714.97	3,357.13	4,129.75	4,720.48	5,134.13	2,446.83	3,326.61	2,928.14	2,421.42	1,924.86	2,402.96
150	1,307.84	1,373.53	1,416.02	2,477.89	2,222.36	2,922.75	3,843.06	3,472.89	4,272.17	4,883.25	5,311.03	2,531.23	3,441.31	3,029.14	2,504.90	1,991.24	2,477.23

Determining the Rate

Shipments of More Than 150 Pounds (non-pallet)

Zones	81	82	84	901	902	903	904	905	906	907	908	909	911	912	913	920	921
Price Per Pound	\$8.72	\$9.16	\$9.45	\$16.52	\$14.82	\$19.49	\$25.63	\$23.16	\$28.49	\$32.56	\$35.41	\$16.88	\$22.95	\$20.20	\$16.70	\$13.28	\$16.52
Minimum Rate	1,307.84	1,373.53	1,416.02	2,477.89	2,222.36	2,922.75	3,843.06	3,472.89	4,272.17	4,883.25	5,311.03	2,531.23	3,441.31	3,029.14	2,504.90	1,991.24	2,477.23

Note: For additional information, refer to page 28.

Export

UPS Worldwide Express Freight® Midday

Guaranteed delivery by 12:00 p.m. or 2:00 p.m. to over 30 countries and territories. Delivery is guaranteed on the next business day to Canada, the second business day to Europe and Latin America, and within two to three business days to Asia. Rates include door-to-door and non-door-to-door delivery with routine, in-house customs clearance by UPS Supply Chain Solutions® for palletized shipments of more than 150 pounds.

Door-to-Door

Zones	481	482	484	401	402	403	404	405
151-999 Lbs. (Price per Lb.)	\$9.71	\$10.15	\$10.35	\$18.81	\$15.57	\$19.39	\$29.49	\$24.44
1,000 Lbs. or More (Price per Lb.)	9.03	9.44	9.59	17.50	14.48	18.03	27.43	22.71
Minimum Rate	1,466.21	1,532.65	1,562.85	2,840.31	2,351.07	2,927.89	4,452.99	3,690.44

Zones	406	407	408	409	411	412	413	420	421
151-999 Lbs. (Price per Lb.)	\$29.27	\$34.35	\$37.36	\$16.80	\$20.79	\$21.90	\$17.81	\$14.56	\$18.11
1,000 Lbs. or More (Price per Lb.)	27.18	31.91	34.62	15.79	19.12	20.81	16.56	13.47	16.81
Minimum Rate	4,419.77	5,186.85	5,641.36	2,536.80	3,139.29	3,306.90	2,689.31	2,198.56	2,734.61

Non-Door-to-Door: Drop-off, Hold at Location,
Drop-off and Hold at Location

Zones	481	482	484	401	402	403	404	405
151-999 Lbs. (Price per Lb.)	\$8.77	\$9.20	\$9.43	\$17.81	\$14.65	\$18.47	\$28.49	\$23.52
1,000 Lbs. or More (Price per Lb.)	8.09	8.49	8.67	16.50	13.56	17.11	26.43	21.79
Minimum Rate	1,324.27	1,389.20	1,423.93	2,689.31	2,212.15	2,788.97	4,301.99	3,551.52

Zones	406	407	408	409	411	412	413	420	421
151-999 Lbs. (Price per Lb.)	\$28.37	\$33.43	\$36.44	\$15.84	\$19.87	\$20.94	\$16.86	\$13.64	\$17.19
1,000 Lbs. or More (Price per Lb.)	26.28	30.99	33.70	14.83	18.20	19.85	15.61	12.55	15.89
Minimum Rate	4,283.87	5,047.93	5,502.44	2,391.84	3,000.37	3,161.94	2,545.86	2,059.64	2,595.69

Notes:

- Door-to-door refers to shipments picked up and delivered to addresses designated by the shipper.
- Drop-off refers to shipments that are dropped off at a UPS Worldwide Express Freight® Center and delivered to a designated address.
- Hold at Location refers to shipments picked up at a designated address and held at a UPS Worldwide Express Freight Center for pickup.
- Drop-off and Hold at Location refers to shipments that are dropped off and held at a UPS Worldwide Express Freight Center for pickup.
- For UPS Worldwide Express Freight Midday shipments, additional charges may apply to larger pallets. Pallets exceeding maximum size or weight restrictions (which vary by origin and destination) as set forth at [ups.com/assets/resources/media/wwef_max_dim.pdf](https://www.ups.com/assets/resources/media/wwef_max_dim.pdf) require prior authorization. Refer to page 129 for more information.
- For additional information, refer to page 28.

Export

UPS Worldwide Express Freight®

Guaranteed delivery by end of day to over 75 countries and territories. Delivery is guaranteed on the next business day to Canada, the second business day to Europe and Latin America, and within two to three business days to Asia. Rates include door-to-door and non-door-to-door delivery with routine, in-house customs clearance by UPS Supply Chain Solutions for palletized shipments of more than 150 pounds.

Door-to-Door

Zones	481	482	484	401	402	403	404	405
151-999 Lbs. (Price per Lb.)	\$8.23	\$8.60	\$9.00	\$15.05	\$13.54	\$16.86	\$23.59	\$21.25
1,000 Lbs. or More (Price per Lb.)	7.65	8.00	8.34	14.00	12.59	15.68	21.94	19.75
Minimum Rate	1,242.73	1,298.60	1,359.00	2,272.55	2,044.54	2,545.86	3,562.09	3,208.75

Zones	406	407	408	409	411	412	413	420	421
151-999 Lbs. (Price per Lb.)	\$26.13	\$29.87	\$32.49	\$14.00	\$18.08	\$18.25	\$15.09	\$12.66	\$15.75
1,000 Lbs. or More (Price per Lb.)	24.26	27.75	30.11	13.16	16.63	17.34	14.03	11.71	14.63
Minimum Rate	3,945.63	4,510.37	4,905.99	2,114.00	2,730.08	2,755.75	2,278.59	1,911.66	2,378.25

Non-Door-to-Door: Drop-off, Hold at Location,
Drop-off and Hold at Location

Zones	481	482	484	401	402	403	404	405
151-999 Lbs. (Price per Lb.)	\$7.43	\$7.80	\$8.20	\$14.25	\$12.74	\$16.06	\$22.79	\$20.45
1,000 Lbs. or More (Price per Lb.)	6.85	7.20	7.54	13.20	11.79	14.88	21.14	18.95
Minimum Rate	1,121.93	1,177.80	1,238.20	2,151.75	1,923.74	2,425.06	3,441.29	3,087.95

Zones	406	407	408	409	411	412	413	420	421
151-999 Lbs. (Price per Lb.)	\$25.33	\$29.07	\$31.69	\$13.20	\$17.28	\$17.45	\$14.29	\$11.86	\$14.95
1,000 Lbs. or More (Price per Lb.)	23.46	26.95	29.31	12.36	15.83	16.54	13.23	10.91	13.83
Minimum Rate	3,824.83	4,389.57	4,785.19	1,993.20	2,609.28	2,634.95	2,157.79	1,790.86	2,257.45

Notes:

- Door-to-door refers to shipments picked up and delivered to addresses designated by the shipper.
- Drop-off refers to shipments that are dropped off at a UPS Worldwide Express Freight Center and delivered to a designated address.
- Hold at Location refers to shipments picked up at a designated address and held at a UPS Worldwide Express Freight Center for pickup.
- Drop-off and Hold at Location refers to shipments that are dropped off and held at a UPS Worldwide Express Freight Center for pickup.
- For UPS Worldwide Express Freight shipments, additional charges may apply to larger pallets. Pallets exceeding maximum size or weight restrictions (which vary by origin and destination) as set forth at [ups.com/assets/resources/media/wwef_max_dim.pdf](https://www.ups.com/assets/resources/media/wwef_max_dim.pdf) require prior authorization. Refer to page 129 for more information.
- For additional information, refer to page 28.

Export

UPS Worldwide Saver®

Guaranteed delivery by end of business day to more than 220 countries and territories. Delivery is guaranteed on the next business day to Canada and for documents to Mexico, the second business day to Europe and Latin America, and within two to three business days to Asia. Rates include door-to-door delivery with routine, in-house customs clearance by UPS Supply Chain Solutions.

Zones	481	482	484	401	402	403	404	405	406	407	408	409	411	412	413	420	421
Letter*	\$54.13	\$59.00	\$60.05	\$77.43	\$66.56	\$80.64	\$97.52	\$88.86	\$115.27	\$155.65	\$165.23	\$75.87	\$90.86	\$83.75	\$71.55	\$63.85	\$76.74
Pak 1 Lb.**	90.37	99.39	81.61	105.23	87.75	112.68	131.31	116.55	130.28	177.34	170.25	100.13	118.34	112.65	95.59	84.17	94.40
Pak 2 Lbs.**	99.40	109.70	85.68	111.24	98.10	116.07	142.94	124.27	174.79	210.82	204.19	109.94	137.77	123.58	105.72	94.10	126.44
10 KG Box†	183.92	220.33	227.60	276.21	263.51	308.23	375.30	323.28	508.96	433.58	469.45	282.56	339.58	320.24	280.81	237.75	388.87
25 KG Box†	296.85	347.67	359.36	420.73	397.57	474.89	635.28	575.85	847.93	836.98	786.11	439.15	533.60	529.97	436.98	391.21	670.58
1 Lb.	112.07	123.31	113.63	138.63	123.99	158.78	148.68	146.51	178.65	218.22	231.26	128.88	157.92	141.79	123.50	113.32	117.24
2	118.78	133.52	127.77	147.94	124.82	180.34	185.75	166.14	209.48	235.52	250.52	141.93	175.21	163.43	144.84	121.94	145.24
3	132.47	145.79	142.12	171.47	136.79	201.04	213.36	192.00	245.05	283.89	284.06	168.06	195.44	183.77	166.00	133.64	156.25
4	145.89	160.26	159.74	195.51	155.58	225.02	247.38	218.60	294.32	325.27	321.98	193.07	214.84	208.08	193.27	149.09	176.26
5	155.45	189.81	182.04	228.11	175.47	243.85	279.01	259.84	317.58	367.80	361.31	234.27	256.85	252.37	246.70	168.16	197.05
6	165.27	199.94	200.63	240.28	190.54	259.74	296.35	278.80	362.10	381.74	399.29	244.93	285.70	275.57	263.06	182.59	229.45
7	169.52	203.80	214.21	254.11	204.00	284.74	322.57	303.48	402.24	410.54	424.87	257.41	308.68	296.26	277.28	195.49	254.68
8	174.77	210.59	222.77	265.25	215.80	304.71	347.41	320.46	478.85	426.29	454.91	266.40	333.95	310.23	277.56	206.80	278.71
9	175.19	213.09	224.46	266.47	217.54	305.16	353.69	322.45	486.44	432.74	472.35	267.58	337.23	313.09	277.61	208.47	311.10
10	176.25	216.45	227.99	274.58	222.53	310.03	364.64	323.70	489.96	434.57	481.71	272.70	338.82	314.84	278.54	213.26	326.67
11	182.59	216.55	233.56	275.20	233.24	320.94	364.69	332.15	504.41	450.28	481.95	279.39	345.98	330.61	282.18	223.53	343.69
12	184.73	226.93	242.38	284.03	242.37	324.79	370.58	340.91	508.10	464.25	496.01	288.88	360.38	334.10	287.37	232.25	368.44
13	219.69	260.13	285.33	323.81	254.60	379.49	450.02	409.50	613.40	543.02	597.00	343.62	409.79	406.96	352.21	243.98	384.86
14	238.60	273.41	315.69	367.72	265.93	418.45	509.59	456.01	659.63	616.02	663.88	374.09	499.19	456.66	376.40	254.84	400.46
15	247.85	282.62	337.88	380.38	295.16	444.16	544.37	506.73	693.90	667.83	672.26	387.66	509.11	479.10	397.22	282.86	423.57
16	262.52	300.26	340.10	393.73	313.99	462.77	566.32	517.62	776.15	761.11	729.65	403.17	529.01	504.02	416.09	300.89	443.76
17	270.06	309.05	341.38	401.97	316.15	464.62	583.04	518.75	782.37	770.41	778.50	416.72	533.92	517.72	418.39	302.97	460.31
18	275.63	310.32	342.67	403.07	318.12	465.86	584.67	519.89	809.76	793.81	820.25	420.14	535.06	518.98	419.63	304.86	471.37
19	276.83	313.50	343.97	404.17	339.31	467.02	585.94	521.02	820.61	835.80	822.49	421.40	536.22	520.26	420.90	325.16	491.52
20	278.02	314.76	345.25	405.27	351.94	468.21	587.16	522.16	822.24	845.41	826.52	422.67	537.37	523.93	422.18	337.26	507.33
21	280.52	324.98	346.49	408.31	355.91	469.27	593.87	523.28	823.46	846.57	827.62	423.83	538.52	528.54	422.30	341.08	514.90
22	281.72	326.25	347.59	409.37	357.16	470.32	595.12	524.42	824.68	847.73	828.72	425.01	539.66	529.99	424.44	342.27	530.12
23	285.59	327.51	348.70	410.44	363.37	471.38	596.37	525.56	825.90	849.29	837.83	426.19	540.81	531.25	435.50	348.22	541.91
24	293.63	329.48	352.97	416.49	365.05	477.90	600.90	553.62	851.70	850.34	868.07	432.23	555.11	535.00	437.14	349.83	558.06
25	294.74	332.34	357.60	420.46	372.93	493.25	608.78	564.08	862.82	852.49	891.27	442.10	563.86	548.68	442.28	357.38	575.91

*The Letter rate applies only to documents, correspondence and electronic media shipments of no commercial value that do not exceed eight ounces sent in a UPS Express® Envelope.

**UPS Express® Pak rates apply to shipments weighing two pounds or less, with a customs value of less than \$100.00 and UPS Express Pak is selected at the time of shipping.

† Shipments exceeding the maximum weights (10 KG/22 pounds and 25 KG/55 pounds) will be charged the regular UPS Worldwide Saver rate. Available only when the shipper is paying the shipping charges.

Note: For additional information, refer to page 28.

Export

UPS Worldwide Saver®

Zones	481	482	484	401	402	403	404	405	406	407	408	409	411	412	413	420	421
26 Lbs.	\$348.12	\$403.91	\$413.25	\$542.31	\$404.33	\$639.77	\$761.61	\$639.37	\$1,018.78	\$1,027.29	\$964.68	\$552.64	\$718.82	\$688.37	\$539.59	\$387.46	\$594.72
27	370.70	417.75	462.19	582.70	412.62	664.21	805.04	718.90	1,096.70	1,164.10	1,150.25	583.50	794.32	730.70	597.18	395.42	602.59
28	383.65	438.64	485.15	599.45	413.90	673.16	834.84	723.89	1,104.50	1,217.13	1,190.38	600.61	801.95	744.03	610.61	396.63	617.83
29	387.13	443.82	487.48	610.62	415.19	689.87	858.73	784.75	1,154.18	1,248.02	1,204.76	602.01	804.38	779.90	611.77	397.88	633.04
30	387.18	449.95	488.76	623.45	424.83	707.30	862.15	804.04	1,163.25	1,254.47	1,219.06	607.11	807.35	784.16	631.52	407.12	647.00
31	400.25	463.57	490.05	636.64	439.31	725.62	912.28	811.59	1,165.96	1,255.79	1,246.70	627.73	866.66	809.77	657.80	421.00	663.91
32	408.59	471.29	491.20	640.09	458.62	729.56	939.80	812.73	1,171.62	1,258.66	1,248.37	663.11	899.75	827.02	671.75	439.50	679.15
33	416.91	480.76	518.24	674.22	468.55	742.00	961.30	831.16	1,258.39	1,287.44	1,253.37	676.12	903.06	830.33	694.02	449.01	694.02
34	421.12	488.50	522.39	683.04	485.77	743.32	982.13	850.73	1,267.09	1,294.33	1,259.64	687.12	906.85	855.19	704.95	465.51	708.60
35	427.91	496.24	523.59	706.43	487.86	754.16	1,003.65	852.94	1,342.24	1,368.52	1,260.98	688.54	983.20	865.36	706.24	467.50	731.21
36	428.99	502.11	524.95	724.02	529.17	764.45	1,019.79	854.07	1,390.40	1,376.54	1,287.76	689.86	990.81	922.72	721.36	507.12	738.25
37	446.59	513.29	526.25	726.86	558.67	771.15	1,057.69	855.20	1,411.52	1,378.21	1,312.61	731.05	992.00	935.91	750.26	535.37	754.43
38	452.61	520.35	527.56	728.77	561.65	795.11	1,090.19	888.58	1,428.72	1,379.48	1,315.10	743.82	998.68	940.08	763.84	538.23	769.47
39	460.61	527.24	536.66	761.98	573.16	805.36	1,112.99	904.57	1,429.89	1,380.72	1,327.05	757.77	1,000.32	979.54	777.79	549.26	783.89
40	468.93	536.03	537.96	776.88	574.43	842.58	1,114.95	906.18	1,431.06	1,382.01	1,383.35	762.04	1,001.69	981.08	788.31	550.47	799.87
41	477.26	539.36	543.33	790.23	585.36	846.32	1,136.39	938.07	1,432.24	1,383.42	1,474.24	782.29	1,054.24	984.12	790.12	560.95	816.17
42	484.93	551.23	566.66	800.58	587.82	850.96	1,158.01	956.75	1,453.34	1,405.00	1,498.36	794.64	1,078.06	1,028.66	815.79	563.31	831.70
43	491.12	561.44	576.81	816.58	589.10	902.98	1,179.46	958.87	1,463.10	1,476.77	1,552.97	807.64	1,123.44	1,042.88	829.57	564.54	860.79
44	498.31	570.05	581.37	827.41	599.54	939.30	1,201.43	1,001.07	1,464.29	1,514.12	1,558.45	819.90	1,138.40	1,063.90	841.48	574.54	867.23
45	505.82	576.97	589.46	840.11	601.58	962.98	1,223.08	1,078.52	1,465.47	1,518.74	1,565.52	832.93	1,140.45	1,085.94	854.88	576.49	891.69
46	511.69	589.60	606.88	853.27	642.01	971.19	1,250.05	1,086.26	1,466.64	1,611.40	1,707.10	841.59	1,181.59	1,095.66	863.78	615.24	908.21
47	519.19	595.49	617.01	868.14	646.07	979.20	1,266.14	1,145.77	1,467.82	1,682.13	1,721.34	855.32	1,185.76	1,110.86	878.38	619.12	926.96
48	526.21	606.45	625.09	881.11	647.35	1,008.88	1,287.76	1,151.73	1,482.40	1,689.22	1,722.78	868.32	1,186.95	1,128.81	889.64	620.36	945.75
49	532.07	612.51	631.97	893.65	671.97	1,011.89	1,308.70	1,170.32	1,494.56	1,767.98	1,724.02	882.04	1,188.14	1,130.28	905.17	643.97	964.37
50	539.76	621.39	633.11	894.83	674.47	1,014.27	1,328.56	1,173.94	1,520.00	1,775.87	1,725.27	894.52	1,190.79	1,131.83	918.07	646.36	983.60
52	555.86	633.56	636.62	931.18	720.71	1,064.63	1,377.97	1,246.88	1,715.12	1,781.61	1,783.92	910.22	1,280.89	1,141.35	934.30	690.66	993.30
54	561.71	641.31	668.52	951.17	729.10	1,087.78	1,404.08	1,254.63	1,726.68	1,785.47	1,790.34	926.00	1,336.33	1,199.54	947.67	698.70	1,025.60
56	573.09	653.60	680.75	980.85	758.99	1,107.85	1,454.61	1,258.38	1,807.22	1,871.29	1,805.04	954.88	1,354.74	1,242.61	978.76	727.34	1,056.15
58	585.12	665.73	693.90	1,010.56	788.87	1,118.84	1,506.22	1,262.10	1,858.73	1,970.47	1,819.72	983.77	1,373.15	1,285.52	1,011.82	755.97	1,089.98
60	602.56	680.59	697.42	1,043.89	792.69	1,200.49	1,570.67	1,268.11	1,892.22	2,034.13	1,912.31	1,021.81	1,520.15	1,384.35	1,049.33	759.64	1,122.89
62	613.96	693.21	718.02	1,056.43	838.38	1,218.50	1,622.05	1,320.74	1,896.06	2,041.83	1,916.92	1,048.58	1,524.94	1,411.52	1,092.36	803.42	1,156.90
64	625.40	703.51	721.56	1,102.45	843.39	1,222.30	1,674.20	1,394.05	1,899.96	2,045.67	1,954.64	1,075.34	1,528.96	1,456.53	1,115.96	808.22	1,193.77
66	633.72	714.96	733.39	1,130.49	849.90	1,226.09	1,714.71	1,399.37	1,993.31	2,049.49	1,958.64	1,102.10	1,604.08	1,471.55	1,138.01	814.46	1,225.83
68	646.89	727.09	761.07	1,159.50	907.40	1,292.89	1,728.04	1,484.77	2,153.61	2,092.93	2,132.46	1,128.83	1,608.22	1,483.54	1,171.30	869.56	1,268.77
70	659.35	740.52	772.37	1,187.01	911.25	1,311.28	1,815.53	1,502.02	2,169.17	2,122.49	2,151.28	1,155.55	1,611.86	1,525.23	1,199.30	873.25	1,302.04

Note: For additional information, refer to page 28.

Export

UPS Worldwide Saver®

Zones	481	482	484	401	402	403	404	405	406	407	408	409	411	412	413	420	421
72 Lbs.	\$685.25	\$744.74	\$776.34	\$1,212.39	\$946.25	\$1,368.54	\$1,888.69	\$1,587.63	\$2,172.78	\$2,129.13	\$2,203.31	\$1,163.90	\$1,677.78	\$1,563.31	\$1,209.41	\$906.80	\$1,337.93
74	714.40	751.84	779.86	1,239.53	950.22	1,418.48	1,924.82	1,597.68	2,179.24	2,210.82	2,256.54	1,206.89	1,719.40	1,602.27	1,224.10	910.61	1,374.89
76	733.83	763.65	783.37	1,243.13	1,019.63	1,431.63	1,933.36	1,670.37	2,334.91	2,282.64	2,260.36	1,233.60	1,767.32	1,643.62	1,280.00	977.11	1,408.77
78	740.56	773.59	808.91	1,278.02	1,026.90	1,436.42	1,982.84	1,674.04	2,338.97	2,292.24	2,275.07	1,260.36	1,772.19	1,743.70	1,307.93	984.08	1,445.35
80	749.20	783.25	816.37	1,299.28	1,033.32	1,506.70	2,000.49	1,706.09	2,364.73	2,302.76	2,295.51	1,287.05	1,775.83	1,777.12	1,338.56	990.23	1,470.58
82	756.97	792.87	842.24	1,335.52	1,037.14	1,510.51	2,004.37	1,709.74	2,368.34	2,306.72	2,338.60	1,290.71	1,780.72	1,793.81	1,342.65	993.90	1,477.21
84	763.88	802.35	850.56	1,364.28	1,108.03	1,514.30	2,101.35	1,713.38	2,371.95	2,347.58	2,342.00	1,294.39	1,875.28	1,797.38	1,352.17	1,061.82	1,513.45
86	772.33	809.45	854.76	1,385.48	1,115.80	1,517.65	2,137.49	1,745.50	2,375.56	2,414.68	2,482.05	1,356.63	1,881.45	1,800.93	1,402.99	1,069.26	1,543.68
88	780.96	823.86	858.75	1,412.33	1,119.98	1,562.35	2,173.41	1,749.14	2,379.17	2,471.13	2,573.41	1,360.06	1,994.66	1,804.50	1,426.49	1,073.27	1,578.14
90	789.60	831.11	879.30	1,422.16	1,136.61	1,626.79	2,209.19	1,844.46	2,382.79	2,474.57	2,645.34	1,395.97	2,015.50	1,808.06	1,450.14	1,089.21	1,614.51
92	797.89	840.05	890.18	1,441.67	1,160.79	1,636.72	2,245.52	1,892.29	2,386.39	2,490.79	2,652.97	1,416.88	2,019.37	1,811.62	1,473.61	1,112.39	1,650.16
94	806.53	849.40	893.69	1,471.87	1,178.97	1,745.40	2,272.75	1,996.18	2,390.01	2,642.35	2,656.84	1,442.33	2,119.59	1,815.17	1,490.70	1,129.81	1,682.30
96	813.01	856.21	897.21	1,483.79	1,212.41	1,781.85	2,297.31	2,012.49	2,393.62	2,802.02	2,791.96	1,470.41	2,133.11	1,884.02	1,520.83	1,161.85	1,711.17
98	816.75	860.00	901.08	1,487.24	1,237.81	1,785.20	2,308.43	2,015.97	2,397.23	2,896.18	2,916.69	1,473.83	2,136.75	1,895.38	1,531.36	1,186.19	1,741.74
100	828.48	867.45	904.97	1,490.80	1,314.09	1,789.07	2,312.27	2,124.85	2,565.45	2,986.71	3,171.96	1,477.63	2,140.39	1,899.30	1,545.38	1,259.29	1,748.01
105	866.58	907.07	947.06	1,561.00	1,440.44	1,882.06	2,412.98	2,230.31	2,693.73	3,136.04	3,427.25	1,551.52	2,230.48	2,000.38	1,621.26	1,328.77	1,816.60
110	907.83	950.26	991.95	1,635.33	1,509.01	1,970.64	2,527.90	2,336.51	2,822.00	3,285.37	3,590.27	1,625.39	2,336.71	2,095.64	1,697.15	1,392.03	1,831.22
115	949.12	993.44	1,036.13	1,709.67	1,577.61	2,059.84	2,642.80	2,442.70	2,950.26	3,434.71	3,749.93	1,699.27	2,442.93	2,190.88	1,772.76	1,455.30	1,889.13
120	990.38	1,036.64	1,081.12	1,783.98	1,646.19	2,149.39	2,757.72	2,548.92	3,078.52	3,584.05	3,909.23	1,773.17	2,549.13	2,286.13	1,848.20	1,518.58	1,964.55
125	1,031.63	1,079.83	1,125.04	1,858.33	1,714.78	2,238.09	2,872.60	2,655.12	3,206.81	3,733.38	4,068.26	1,847.03	2,655.35	2,381.39	1,924.98	1,581.84	2,040.49
130	1,091.22	1,123.00	1,169.17	1,932.66	1,783.39	2,394.34	3,069.72	2,761.33	3,396.83	3,882.70	4,230.83	1,976.33	2,761.54	2,476.64	2,029.69	1,645.13	2,095.58
135	1,133.16	1,166.21	1,213.92	2,006.98	1,851.97	2,486.22	3,187.80	2,867.53	3,527.48	4,032.05	4,389.55	2,052.34	2,867.76	2,571.90	2,116.92	1,708.40	2,148.98
140	1,174.96	1,209.40	1,258.81	2,081.31	1,920.57	2,576.00	3,305.86	2,973.74	3,658.14	4,181.39	4,551.97	2,128.33	2,973.99	2,667.14	2,195.26	1,771.68	2,219.48
145	1,215.95	1,252.58	1,303.71	2,197.50	1,989.16	2,666.74	3,423.93	3,079.93	3,788.76	4,330.71	4,710.21	2,204.35	3,080.19	2,762.39	2,273.63	1,834.94	2,290.71
150	1,257.53	1,295.78	1,348.59	2,273.29	2,057.74	2,770.37	3,541.99	3,186.13	3,919.42	4,480.04	4,872.50	2,280.38	3,186.39	2,857.67	2,352.01	1,898.22	2,361.51

Shipments of More Than 150 Pounds

Zones	481	482	484	401	402	403	404	405	406	407	408	409	411	412	413	420	421
Price Per Pound	\$8.39	\$8.64	\$9.00	\$15.16	\$13.72	\$18.47	\$23.62	\$21.25	\$26.13	\$29.87	\$32.49	\$15.21	\$21.25	\$19.06	\$15.69	\$12.66	\$15.75
Minimum Rate	1,257.53	1,295.78	1,348.59	2,273.29	2,057.74	2,770.37	3,541.99	3,186.13	3,919.42	4,480.04	4,872.50	2,280.38	3,186.39	2,857.67	2,352.01	1,898.22	2,361.51

Note: For additional information, refer to page 28.

Export

UPS Worldwide Expedited®

Delivery by end of business day to more than 220 countries and territories. Delivery in two business days to Canada, three business days to Mexico, three to four business days to Europe, and four to five business days to Asia and Latin America. Rates include door-to-door delivery with routine, in-house customs clearance by UPS Supply Chain Solutions.

Zones	71	72	74	601/631	602/632	603/633	604/634	605/635	606/636	607/637	608/638	609/639	611/641	612/642	613/643	620	621
1 Lbs.	\$104.93	\$111.68	\$93.03	\$121.07	\$95.53	\$125.12	\$139.51	\$124.02	\$171.25	\$131.09	\$121.99	\$117.65	\$129.32	\$131.21	\$113.74	\$94.80	\$106.97
2	110.79	123.71	101.52	138.77	119.67	157.17	172.29	150.59	190.12	176.73	167.35	131.90	144.11	149.56	131.02	109.50	131.75
3	119.42	134.94	119.52	162.28	133.60	176.78	194.66	164.35	214.63	208.64	210.08	157.87	170.77	175.56	149.33	120.08	147.23
4	127.53	147.05	121.32	183.41	147.40	195.00	214.56	186.23	250.53	260.07	248.23	177.35	180.92	193.22	168.53	132.89	164.82
5	145.41	170.18	145.09	210.19	154.83	231.21	245.37	214.70	275.49	293.24	280.62	201.77	204.75	203.87	198.57	145.53	178.30
6	150.61	170.95	151.69	225.89	172.96	248.02	268.62	230.45	319.33	315.56	324.34	230.29	225.19	235.01	216.29	163.00	213.70
7	156.50	181.23	172.97	233.37	192.59	255.65	295.52	262.76	345.38	350.32	339.65	235.54	249.10	245.38	217.79	174.77	222.27
8	163.70	187.35	183.71	234.14	193.42	273.00	319.34	271.30	393.10	360.43	379.50	245.27	272.79	273.41	221.65	179.40	254.34
9	165.20	198.35	184.55	244.71	199.04	289.57	345.11	301.81	424.56	394.87	435.76	251.67	294.10	288.46	253.58	186.66	270.88
10	170.22	201.68	185.72	245.48	210.98	290.34	349.39	305.52	430.66	395.66	436.97	258.79	303.86	300.91	255.23	191.82	288.04
11	174.23	202.45	211.94	259.70	218.88	301.33	350.16	306.29	451.26	412.33	447.81	262.79	317.18	314.35	267.18	199.16	293.25
12	177.50	203.96	212.79	263.77	225.20	307.23	355.74	308.69	459.41	421.08	452.44	263.65	324.69	315.17	271.88	205.03	309.32
13	191.46	234.12	224.36	290.32	238.35	346.93	443.95	353.02	535.30	459.36	492.95	292.98	344.58	365.14	321.05	217.22	337.17
14	198.00	241.41	225.32	310.61	246.41	381.59	471.27	384.91	571.52	527.11	587.23	303.91	396.70	385.71	325.29	224.68	352.74
15	204.52	254.10	232.27	317.79	253.10	387.30	491.33	408.39	585.49	595.21	588.08	323.86	452.27	394.54	329.69	236.06	355.31
16	218.01	259.57	235.16	356.68	275.94	405.20	515.20	442.41	609.10	628.74	588.93	345.64	463.15	417.99	334.01	252.06	378.10
17	219.71	260.45	247.08	358.34	282.71	413.94	529.88	448.36	637.92	643.18	589.78	363.00	470.51	435.16	341.92	258.34	402.70
18	225.50	266.20	251.24	363.81	294.11	421.04	534.09	460.86	680.63	669.69	645.35	365.39	486.19	441.56	370.17	268.92	415.14
19	231.10	272.50	275.58	365.09	303.92	440.09	563.83	486.52	705.48	700.90	656.34	384.68	494.45	455.98	375.13	278.00	428.39
20	236.75	278.73	285.30	381.64	304.75	442.45	566.30	488.13	707.79	740.94	698.59	398.17	495.36	488.87	375.44	282.10	442.39
21	262.57	305.97	286.15	387.68	325.19	453.26	572.55	490.04	736.96	787.07	784.57	398.99	496.25	492.11	386.70	297.73	456.62
22	268.79	306.86	286.99	388.56	335.22	454.15	574.74	490.93	751.20	791.19	794.47	399.81	497.15	494.32	407.13	307.03	469.66
23	273.99	309.69	293.87	389.44	341.86	455.08	579.61	491.82	752.10	808.26	803.87	400.62	498.05	495.41	412.04	313.18	474.71
24	282.03	310.69	303.43	394.04	345.30	463.16	581.01	492.68	758.65	809.13	804.76	401.44	506.02	500.30	414.89	316.37	482.84
25	282.93	314.73	304.34	395.89	349.62	475.11	586.09	498.25	763.02	819.37	830.41	410.06	510.87	507.21	416.36	320.38	502.76
26	315.29	350.06	316.35	511.84	372.71	613.01	692.66	599.38	835.18	901.40	860.34	517.06	636.02	620.00	469.06	341.80	522.10
27	322.88	382.59	317.33	523.75	388.33	635.91	758.98	611.17	857.20	917.40	946.09	550.84	687.55	655.50	489.51	356.27	522.25
28	334.96	385.43	326.01	537.34	389.34	648.78	790.30	670.60	871.36	968.65	946.97	551.77	712.12	659.69	491.86	357.22	541.15
29	340.04	386.62	335.03	548.77	394.10	665.70	828.68	694.34	916.49	1,035.17	967.57	559.77	715.01	735.81	525.72	361.62	559.86
30	341.12	401.19	346.34	551.34	400.32	681.23	835.60	696.23	923.71	1,040.24	968.62	560.70	715.98	737.06	558.55	367.39	573.48
31	347.83	402.68	350.75	563.05	413.60	703.00	877.02	713.57	983.02	1,041.23	986.41	569.18	731.96	752.07	569.74	379.70	591.23
32	355.37	418.76	351.63	563.91	429.05	704.02	880.12	720.53	1,002.98	1,042.22	987.39	589.67	735.40	753.12	600.51	394.02	607.47
33	362.87	426.28	352.51	564.79	437.12	712.89	895.58	729.14	1,011.62	1,064.59	988.34	591.57	775.18	775.99	610.34	401.52	615.02
34	370.40	427.38	355.87	566.31	444.05	714.97	912.66	730.94	1,013.50	1,079.31	989.30	643.37	802.67	778.27	610.90	407.94	623.09
35	377.97	434.01	356.82	567.32	452.09	723.28	937.16	732.14	1,016.12	1,082.94	990.23	655.32	817.86	780.94	614.38	415.41	639.24

Note: For additional information, refer to page 28.

Export

UPS Worldwide Expedited®

Zones	71	72	74	601/631	602/632	603/633	604/634	605/635	606/636	607/637	608/638	609/639	611/641	612/642	613/643	620	621
36 Lbs.	\$385.46	\$441.69	\$358.76	\$568.29	\$459.10	\$737.88	\$964.55	\$733.12	\$1,017.35	\$1,098.60	\$991.20	\$656.47	\$832.04	\$833.88	\$655.28	\$421.89	\$643.46
37	392.92	450.07	365.43	569.31	466.05	742.49	967.30	734.06	1,025.90	1,132.05	992.13	667.35	833.30	876.83	657.77	428.33	659.03
38	400.46	458.43	366.39	583.26	474.04	760.09	999.22	747.13	1,091.43	1,160.69	1,059.08	668.17	841.33	893.33	681.57	435.74	675.58
39	408.01	466.79	369.83	621.54	482.49	774.36	1,027.25	800.83	1,114.63	1,161.56	1,066.48	668.98	842.52	896.87	686.48	443.59	686.11
40	415.56	479.43	370.78	624.21	490.92	810.91	1,031.00	845.17	1,124.91	1,197.67	1,068.55	669.80	845.66	899.80	688.23	451.39	691.91
41	423.10	480.73	371.75	636.52	497.41	813.32	1,057.15	853.29	1,125.98	1,215.06	1,082.67	678.06	890.24	924.26	705.35	454.30	702.58
42	430.71	487.67	372.85	638.36	502.41	815.36	1,059.77	863.30	1,133.50	1,321.21	1,165.46	706.31	906.83	926.74	708.90	458.85	715.69
43	438.28	496.70	375.56	647.71	509.32	861.82	1,094.25	875.94	1,142.50	1,355.96	1,251.98	724.09	974.25	929.15	721.74	465.18	730.59
44	445.88	503.64	378.21	674.22	515.73	903.91	1,109.22	888.48	1,171.83	1,374.40	1,261.16	725.00	975.13	976.61	724.59	471.02	743.66
45	453.52	510.65	393.22	676.87	522.15	906.23	1,130.78	920.39	1,176.23	1,377.12	1,299.87	725.91	976.02	998.88	750.55	476.89	759.24
46	461.08	516.95	398.71	680.06	529.64	907.27	1,132.93	931.62	1,178.62	1,379.46	1,331.24	726.83	976.91	1,001.14	754.77	483.73	774.20
47	473.67	524.58	399.58	681.05	546.82	928.74	1,134.04	932.58	1,194.78	1,436.84	1,333.53	731.38	1,015.97	1,002.42	763.54	499.41	789.87
48	474.92	536.63	400.46	681.93	551.02	944.94	1,148.41	939.84	1,256.72	1,501.53	1,335.92	732.30	1,019.08	1,011.47	767.90	503.25	806.26
49	480.47	537.88	403.19	685.63	551.97	945.98	1,183.33	980.83	1,294.96	1,513.59	1,383.71	763.62	1,049.42	1,012.54	770.52	504.12	821.76
50	486.74	544.83	404.14	695.74	556.41	947.67	1,186.83	985.44	1,296.14	1,520.13	1,388.49	768.28	1,055.57	1,013.58	771.61	508.18	838.46
52	508.65	564.34	413.13	707.49	577.31	949.06	1,216.37	1,017.50	1,342.36	1,523.41	1,435.41	781.42	1,057.06	1,029.51	800.83	527.28	855.77
54	513.35	571.21	416.71	730.89	584.38	961.98	1,243.30	1,018.99	1,359.18	1,587.62	1,436.85	782.94	1,103.70	1,031.05	810.77	533.73	886.69
56	525.22	584.05	430.93	749.64	597.83	973.41	1,275.49	1,112.80	1,360.80	1,596.18	1,438.29	827.96	1,105.36	1,037.86	830.15	546.02	918.67
58	534.90	596.90	434.05	778.52	610.80	985.60	1,307.77	1,129.36	1,362.40	1,597.85	1,439.73	847.78	1,114.38	1,040.83	851.67	557.86	950.85
60	546.92	625.71	435.68	803.96	622.10	998.24	1,310.45	1,143.29	1,364.02	1,599.53	1,441.17	861.32	1,138.22	1,056.26	880.54	568.17	982.99
62	559.31	637.16	449.16	805.64	635.48	1,021.24	1,333.39	1,157.87	1,374.79	1,601.16	1,485.89	862.69	1,139.73	1,058.29	904.38	580.39	1,015.35
64	582.57	643.73	453.79	807.31	655.79	1,028.92	1,342.43	1,159.42	1,376.41	1,678.93	1,508.55	864.05	1,187.79	1,063.27	911.77	598.94	1,046.63
66	589.66	650.01	461.55	811.09	663.07	1,122.94	1,351.76	1,160.89	1,378.03	1,690.31	1,510.05	920.73	1,204.19	1,068.29	931.42	605.59	1,077.87
68	596.41	661.83	469.32	840.00	676.38	1,124.65	1,361.06	1,162.38	1,401.87	1,691.87	1,545.82	922.25	1,216.12	1,073.33	945.26	617.74	1,110.07
70	598.00	674.02	476.97	863.35	689.90	1,126.37	1,370.39	1,206.25	1,450.32	1,693.43	1,579.79	929.04	1,219.80	1,078.35	958.96	630.08	1,141.66
72	615.68	675.38	484.75	896.45	704.18	1,128.27	1,392.67	1,217.07	1,506.59	1,694.98	1,581.28	962.28	1,338.92	1,081.15	972.60	643.13	1,173.18
74	641.92	690.00	492.49	898.21	716.78	1,129.98	1,402.07	1,218.54	1,508.11	1,696.54	1,639.03	983.24	1,340.41	1,088.39	986.24	654.65	1,204.77
76	649.64	692.32	500.18	899.99	730.18	1,131.69	1,411.46	1,220.02	1,509.61	1,698.10	1,698.59	1,046.15	1,348.71	1,093.48	999.93	666.88	1,236.59
78	654.93	693.93	507.96	901.45	742.53	1,184.17	1,420.84	1,254.34	1,511.12	1,699.64	1,704.78	1,062.86	1,350.45	1,095.01	1,013.55	678.15	1,268.11
80	660.25	695.53	519.95	905.38	753.47	1,185.65	1,430.25	1,255.91	1,621.74	1,707.06	1,706.51	1,079.55	1,352.19	1,100.79	1,027.20	688.15	1,298.88
82	665.55	696.90	530.35	907.82	773.39	1,187.15	1,439.66	1,273.16	1,623.25	1,720.20	1,708.16	1,082.48	1,356.87	1,102.32	1,040.86	706.34	1,324.10
84	670.86	698.27	531.98	909.28	775.37	1,188.64	1,449.05	1,274.64	1,624.77	1,842.28	1,709.64	1,084.05	1,358.59	1,103.85	1,054.50	708.14	1,348.92
86	676.01	699.64	552.98	923.56	786.30	1,190.12	1,458.43	1,290.33	1,626.28	1,843.74	1,715.12	1,129.64	1,360.35	1,105.37	1,068.12	718.14	1,360.15
88	680.39	701.00	565.96	946.71	797.31	1,191.61	1,464.11	1,291.87	1,627.79	1,845.20	1,716.72	1,137.07	1,429.50	1,106.91	1,081.80	728.20	1,393.87
90	681.99	702.37	567.59	958.45	816.69	1,193.10	1,465.73	1,293.75	1,629.29	1,859.47	1,721.23	1,138.61	1,447.08	1,108.44	1,084.98	745.88	1,424.56

Note: For additional information, refer to page 28.

Export

UPS Worldwide Expedited[®]

Zones	71	72	74	601/631	602/632	603/633	604/634	605/635	606/636	607/637	608/638	609/639	611/641	612/642	613/643	620	621
92 Lbs.	\$683.36	\$703.74	\$573.07	\$981.80	\$819.16	\$1,194.59	\$1,467.35	\$1,308.71	\$1,630.81	\$1,873.03	\$1,818.26	\$1,140.17	\$1,454.32	\$1,109.96	\$1,095.69	\$748.14	\$1,455.17
94	684.72	705.11	574.89	996.78	834.34	1,196.08	1,468.95	1,310.19	1,632.32	1,874.61	1,832.31	1,141.72	1,455.90	1,111.49	1,096.62	762.02	1,485.63
96	686.09	706.47	587.34	1,004.71	841.10	1,197.58	1,470.58	1,311.86	1,633.84	1,876.33	1,835.22	1,149.29	1,457.43	1,113.02	1,101.59	768.19	1,502.20
98	687.46	707.84	606.97	1,006.29	852.11	1,199.06	1,478.42	1,315.16	1,635.35	1,877.98	1,836.71	1,150.85	1,459.01	1,114.54	1,104.45	778.26	1,504.24
100	688.82	709.21	657.77	1,012.90	942.63	1,200.55	1,480.16	1,332.34	1,663.19	1,974.39	1,912.57	1,152.43	1,577.06	1,116.08	1,126.78	879.64	1,572.87
105	718.10	728.72	675.59	1,050.88	969.43	1,247.82	1,552.94	1,398.89	1,796.77	2,053.47	2,000.43	1,258.83	1,661.11	1,183.01	1,144.68	901.89	1,625.59
110	752.33	763.43	707.75	1,100.79	1,015.59	1,307.25	1,626.88	1,465.30	1,882.33	2,151.24	2,095.70	1,318.78	1,740.20	1,239.34	1,199.32	944.83	1,637.41
115	786.51	798.13	739.91	1,150.93	1,061.76	1,366.66	1,700.83	1,520.86	1,967.90	2,249.02	2,190.95	1,378.70	1,819.32	1,295.68	1,256.02	987.79	1,706.93
120	820.71	832.82	772.09	1,200.82	1,107.91	1,426.09	1,774.77	1,584.20	2,053.46	2,346.80	2,286.21	1,438.66	1,898.40	1,352.01	1,309.24	1,030.72	1,775.51
125	854.91	867.52	804.26	1,250.95	1,154.07	1,485.49	1,848.74	1,665.34	2,139.02	2,444.58	2,381.46	1,498.60	1,977.52	1,408.34	1,361.54	1,073.67	1,830.71
130	889.10	914.75	836.42	1,313.41	1,200.24	1,544.92	1,922.68	1,693.04	2,287.77	2,542.37	2,524.84	1,558.54	2,056.62	1,464.67	1,432.15	1,116.62	1,885.95
135	923.30	949.92	868.59	1,364.04	1,246.41	1,604.33	1,996.64	1,739.51	2,375.76	2,640.16	2,621.94	1,618.48	2,072.94	1,521.02	1,484.97	1,159.57	1,937.84
140	957.49	985.11	900.76	1,414.41	1,292.58	1,663.76	2,070.57	1,791.90	2,463.74	2,737.93	2,719.02	1,678.43	2,139.21	1,577.33	1,538.64	1,202.52	2,004.07
145	991.69	1,020.30	932.94	1,464.56	1,338.73	1,720.71	2,144.53	1,910.16	2,551.75	2,835.72	2,816.13	1,738.35	2,211.79	1,633.68	1,596.72	1,245.44	2,069.20
150	1,025.88	1,055.49	965.09	1,512.55	1,384.90	1,782.58	2,218.46	1,921.84	2,639.74	2,933.49	2,913.23	1,798.32	2,284.11	1,690.01	1,649.10	1,288.40	2,133.43

Shipments of More Than 150 Pounds

Zones	71	72	74	601/631	602/632	603/633	604/634	605/635	606/636	607/637	608/638	609/639	611/641	612/642	613/643	620	621
Price Per Pound	\$6.84	\$7.04	\$6.44	\$10.09	\$9.24	\$11.89	\$14.79	\$12.82	\$17.60	\$19.56	\$19.43	\$11.99	\$15.23	\$11.27	\$11.00	\$8.59	\$14.23
Minimum Rate	1,025.88	1,055.49	965.09	1,512.55	1,384.90	1,782.58	2,218.46	1,921.84	2,639.74	2,933.49	2,913.23	1,798.32	2,284.11	1,690.01	1,649.10	1,288.40	2,133.43

Note: For additional information, refer to page [28](#).

Export

UPS® Standard to Canada*

Delivery to all Canadian provinces by end of day, within two to seven business days. Rates include door-to-door delivery. Customs clearance is not included. For rates, see [ups.com/cacustomsclearance](https://www.ups.com/cacustomsclearance). UPS will provide Customs Brokerage Services by UPS Supply Chain Solutions unless a different broker is specified. Customs Brokerage charges will be billed to the importer unless otherwise indicated by the shipper.

Zones	51	52	53	54	55	56
1 Lbs.	\$25.41	\$25.47	\$25.29	\$40.31	\$40.26	\$39.89
2	27.47	27.52	27.35	42.40	42.35	41.96
3	28.34	28.38	28.29	44.44	44.40	44.00
4	30.34	30.41	30.20	46.85	46.79	46.37
5	32.18	32.24	32.03	47.52	47.40	47.04
6	33.82	34.05	33.90	49.76	50.46	50.01
7	35.37	35.62	35.45	50.56	51.27	50.79
8	36.99	37.24	37.08	52.37	53.10	52.63
9	38.52	38.78	38.60	53.06	53.80	53.31
10	40.12	40.40	40.22	54.78	55.55	55.05
11	42.56	42.70	43.45	59.23	60.19	59.64
12	43.98	44.16	44.93	60.87	61.83	61.29
13	45.73	45.93	46.73	62.38	63.81	63.25
14	46.40	46.59	47.40	63.11	64.54	63.96
15	47.05	47.25	48.25	64.00	65.19	64.58
16	48.62	48.83	48.95	66.20	67.26	66.97
17	49.90	50.11	50.15	68.08	69.16	68.97
18	51.70	51.91	52.02	70.10	71.23	70.85
19	53.32	53.53	53.65	72.14	73.28	73.00
20	54.63	54.86	54.96	74.11	75.28	74.89
21	56.09	56.19	56.41	76.12	77.36	76.66
22	57.76	57.89	58.10	78.34	79.59	78.96
23	59.18	59.32	59.33	80.30	81.57	80.84
24	60.71	60.84	60.92	82.22	82.93	82.82
25	61.89	62.03	62.08	84.20	84.92	84.79
26	63.35	63.48	63.50	86.55	87.27	87.15
27	65.12	65.27	65.31	88.65	89.40	89.26
28	66.68	66.83	66.87	90.86	91.60	91.47
29	68.25	68.37	68.38	92.95	93.75	93.59
30	69.77	69.93	70.06	95.07	95.88	95.73
31	71.09	71.25	71.68	97.36	98.18	98.01
32	72.63	72.78	73.15	99.52	100.36	100.22
33	74.41	74.60	74.86	101.66	102.51	102.37
34	75.82	75.98	76.22	103.78	104.64	104.50
35	77.29	77.46	78.20	105.17	106.05	106.51

*Visit [ups.com/holidays](https://www.ups.com/holidays) for time-in-transit changes effective during the holiday season.

Notes:

- For additional information, refer to pages 28 and 78.
- For a multiple-package shipment, the minimum charge will be based on an average weight of 15 pounds per package.

Export

UPS® Standard to Canada*

Zones	51	52	53	54	55	56
36 Lbs.	\$78.69	\$78.85	\$79.13	\$107.60	\$108.52	\$108.35
37	80.47	80.67	80.91	109.78	110.70	110.54
38	81.93	82.11	82.58	111.68	112.60	112.59
39	83.80	83.98	84.13	113.46	114.40	114.24
40	85.21	85.38	85.77	115.63	116.63	116.45
41	86.68	86.88	87.13	117.61	118.59	118.43
42	88.06	88.26	88.59	119.35	120.37	120.17
43	89.70	89.91	90.21	121.37	122.40	122.21
44	90.83	91.05	91.26	122.93	123.97	123.79
45	92.56	92.77	92.95	125.22	126.27	126.08
46	94.04	94.26	94.63	127.01	128.08	127.89
47	95.50	95.71	96.10	128.96	130.04	129.87
48	96.75	96.96	97.42	130.91	132.02	131.81
49	98.37	98.58	98.77	132.72	133.85	133.65
50	100.01	100.21	100.46	134.85	135.97	135.77
52	103.04	103.28	103.44	137.67	138.81	137.53
54	105.91	106.15	106.32	140.32	141.50	140.42
56	108.39	108.63	108.82	143.22	144.52	144.39
58	115.78	118.22	119.32	146.13	148.36	148.16
60	118.17	119.78	120.33	148.70	150.99	151.11
62	119.53	120.80	121.35	151.91	154.28	155.01
64	120.74	121.82	122.52	154.74	156.11	157.19
66	121.97	122.83	123.69	157.26	159.51	160.64
68	123.18	123.85	124.87	160.07	161.40	164.37
70	124.39	124.87	126.05	163.29	164.68	167.02
72	125.61	125.89	127.22	165.76	167.34	172.52
74	126.83	126.95	128.40	168.89	170.49	177.14
76	128.05	128.14	129.57	172.81	174.45	181.78
78	129.27	129.33	130.75	174.03	175.80	184.97
80	130.49	130.51	131.92	177.95	179.64	189.42
82	131.70	131.71	133.11	181.23	182.96	193.10
84	132.93	132.88	134.28	184.47	186.20	196.73
86	134.15	134.08	135.47	188.60	190.39	200.21
88	135.38	135.28	136.64	191.72	193.53	203.96
90	136.58	136.46	137.82	194.77	196.63	207.38

*Visit [ups.com/holidays](https://www.ups.com/holidays) for time-in-transit changes effective during the holiday season.

Note: For additional information, refer to pages [28](#) and [78](#).

Export UPS® Standard to Canada*

Zones	51	52	53	54	55	56
92 Lbs.	\$137.80	\$137.65	\$138.99	\$198.41	\$200.31	\$211.13
94	139.02	138.84	140.17	201.55	203.48	214.56
96	140.24	140.02	142.13	204.93	206.90	218.10
98	141.46	141.20	145.01	208.52	210.52	221.46
100	142.68	142.22	147.96	211.50	213.52	225.21
105	143.90	143.24	148.93	212.71	214.54	231.63
110	145.07	144.25	151.83	216.62	220.69	240.83
115	146.25	149.39	158.02	225.14	230.05	250.69
120	149.87	154.20	165.12	233.66	238.96	260.31
125	153.37	160.06	171.32	242.19	248.18	269.75
130	156.51	164.20	178.12	250.80	256.20	278.07
135	159.90	168.88	184.55	257.64	261.72	285.77
140	163.21	172.59	190.05	265.90	269.73	294.83
145	166.33	176.75	195.28	277.54	281.70	301.23
150	169.76	180.52	200.76	283.24	287.52	305.10

Shipments of More Than 150 Pounds

Zones	51	52	53	54	55	56
Shipments of 151 to 199 Pounds						
Price Per Pound	\$1.14	\$1.21	\$1.34	\$1.89	\$1.92	\$2.04
Minimum Rate	169.76	180.52	200.76	283.24	287.52	305.10
Shipments of 200 to 499 Pounds						
Price Per Pound	\$1.09	\$1.17	\$1.28	\$1.80	\$1.87	\$1.98
Minimum Rate	226.86	240.79	266.66	376.11	382.08	405.96
Shipments of 500 Pounds or More						
Price Per Pound	\$0.93	\$1.11	\$1.25	\$1.67	\$1.75	\$1.93
Minimum Rate	543.91	583.83	638.72	898.20	933.13	988.02

*Visit [ups.com/holidays](https://www.ups.com/holidays) for time-in-transit changes effective during the holiday season.

Note: For additional information, refer to pages [28](#) and [78](#).

Export

UPS® Standard to Mexico*

Delivery to Mexico by end of day, within four to eight business days. Service not available to Baja California or Baja California Sur. Rates include routine, in-house customs clearance. Customs clearance by UPS Supply Chain Solutions is required.**

Zones	32	33	34	35	36	37	38
1 Lbs.	\$63.10	\$63.58	\$65.05	\$65.62	\$66.17	\$66.46	\$66.60
2	67.31	68.54	69.12	70.14	70.27	70.74	70.85
3	72.13	73.96	74.33	74.80	74.91	76.07	76.14
4	75.97	76.34	76.82	77.28	77.63	79.95	80.16
5	76.35	78.08	78.60	79.96	81.06	82.79	82.93
6	81.08	81.31	81.76	83.26	86.09	86.10	86.13
7	82.83	83.11	83.65	85.07	86.17	88.35	88.61
8	83.05	84.81	85.11	86.78	87.99	93.36	93.76
9	86.06	88.01	88.11	88.65	90.93	94.65	97.18
10	88.35	90.24	90.38	90.92	93.14	96.79	99.38
11	92.52	92.71	92.97	94.87	97.53	101.32	103.84
12	93.43	95.46	95.63	96.09	98.28	101.79	104.43
13	95.94	97.96	98.20	98.68	100.85	104.32	106.99
14	100.27	100.53	100.85	101.16	103.25	108.95	109.85
15	100.89	103.23	103.49	105.15	106.43	110.18	113.46
16	101.48	103.93	104.37	105.84	107.61	113.73	115.00
17	103.94	106.60	106.93	108.69	110.96	116.26	118.58
18	104.96	108.06	108.34	109.27	112.73	116.93	120.80
19	105.19	108.42	108.89	109.82	113.03	117.32	121.45
20	106.21	108.63	109.09	113.65	115.02	119.37	123.84
21	112.06	113.81	114.17	114.41	118.59	123.11	127.74
22	115.45	117.39	117.95	120.93	122.36	127.16	132.12
23	118.25	120.28	120.89	124.00	125.81	130.57	135.82
24	121.10	123.05	124.05	127.20	129.06	134.26	139.58
25	121.35	123.54	124.43	129.97	131.99	137.18	143.07
26	127.99	130.47	131.46	134.39	136.42	144.42	148.44
27	130.36	132.90	133.54	134.66	139.31	145.18	151.67
28	131.92	135.42	136.64	139.81	146.42	149.72	155.17
29	132.13	136.66	138.95	139.99	146.89	151.15	159.00
30	132.52	137.39	139.84	140.34	147.60	151.87	159.99
31	132.75	137.91	139.92	140.51	147.97	152.45	160.44
32	133.46	138.07	140.88	141.51	148.67	155.03	163.20
33	135.90	140.86	143.73	146.25	151.87	158.30	166.84
34	137.90	141.04	145.99	147.06	154.47	161.08	169.94
35	140.21	146.41	148.47	149.58	157.22	164.04	173.13

*Visit ups.com/holidays for time-in-transit changes effective during the holiday season.

**In cases where the shipment cannot be imported, the shipment will be automatically returned to the exporter.

Notes:

- For additional information, refer to pages [28](#) and [78](#).
- For a multiple-package shipment, the minimum charge will be based on an average weight of 15 pounds per package.

Export

UPS® Standard to Mexico*

Zones	32	33	34	35	36	37	38
36 Lbs.	\$142.65	\$148.85	\$151.37	\$155.36	\$160.22	\$167.13	\$176.52
37	149.38	152.86	155.63	159.41	163.63	170.02	178.51
38	153.48	156.96	159.67	162.35	167.70	174.11	182.64
39	154.99	158.76	160.41	162.93	170.35	176.76	185.22
40	155.25	159.84	161.19	165.11	172.27	178.77	187.32
41	157.90	164.79	167.26	167.73	175.11	181.65	190.22
42	160.53	166.55	167.70	170.32	177.70	184.19	192.49
43	162.06	167.01	168.17	175.18	179.27	185.71	194.14
44	164.53	169.08	172.63	176.41	180.19	186.69	195.22
45	165.52	170.51	173.05	176.87	180.76	187.28	195.82
46	168.29	170.72	174.34	177.05	181.96	188.51	196.89
47	170.84	174.29	177.07	177.42	184.58	191.10	199.49
48	171.01	175.90	178.46	179.95	187.15	193.67	202.11
49	172.88	176.35	178.91	182.35	189.63	196.08	204.45
50	174.75	178.19	180.80	184.34	191.44	197.99	206.33
52	178.77	181.67	185.66	187.87	195.88	201.18	209.56
54	184.38	187.96	192.50	194.27	202.10	204.15	210.31
56	189.53	192.04	198.10	198.80	208.20	209.03	216.90
58	191.44	194.28	199.20	201.17	211.15	214.04	221.90
60	195.72	198.84	201.78	205.85	212.12	218.62	226.58
62	199.88	203.14	206.03	210.02	218.20	222.79	230.73
64	206.98	209.67	210.47	214.30	221.66	230.34	237.28
66	207.43	210.59	213.73	218.42	222.43	234.33	241.32
68	211.23	214.60	217.74	222.41	226.25	238.13	245.29
70	215.58	218.67	224.22	226.57	230.23	242.27	249.27
72	219.68	222.72	226.19	230.54	234.36	246.26	253.13
74	224.97	231.01	231.66	234.66	238.09	250.27	257.08
76	226.06	231.53	232.54	238.46	242.01	255.59	261.59
78	228.44	231.64	240.07	242.60	247.94	257.95	263.99
80	230.41	233.61	241.36	243.13	250.08	260.05	266.14

*Visit [ups.com/holidays](https://www.ups.com/holidays) for time-in-transit changes effective during the holiday season.

Note: For additional information, refer to pages [28](#) and [78](#).

Export

UPS® Standard to Mexico*

Zones	32	33	34	35	36	37	38
82 Lbs.	\$233.03	\$236.05	\$242.48	\$245.39	\$252.28	\$262.30	\$268.20
84	236.82	240.01	243.00	249.20	256.05	265.78	271.86
86	240.82	247.62	250.07	254.06	259.82	269.70	275.60
88	244.54	247.81	250.75	256.51	263.40	273.21	279.04
90	248.35	251.57	254.64	260.27	267.09	277.29	282.64
92	251.22	260.50	260.81	263.23	269.75	279.98	285.54
94	255.44	261.94	264.77	266.91	273.40	283.56	289.12
96	258.90	262.29	265.23	269.89	276.10	286.24	291.79
98	262.34	264.66	268.28	272.65	278.67	288.74	294.58
100	266.38	267.97	272.09	275.89	281.88	291.99	297.89
105	276.51	278.50	282.03	285.64	291.39	301.42	307.21
110	287.58	289.20	291.94	295.38	301.07	311.33	317.44
115	295.81	297.63	300.66	303.66	309.52	319.89	325.98
120	304.30	306.24	309.20	311.86	318.04	328.62	334.83
125	313.05	314.76	318.04	320.14	326.31	336.92	343.24
130	321.49	323.56	326.81	328.66	334.63	345.42	351.76
135	329.96	332.51	335.81	336.95	343.01	353.74	359.95
140	338.71	341.64	344.91	345.84	351.74	362.09	368.64
145	348.03	351.24	354.77	354.99	360.80	371.13	377.85
150	357.07	360.96	364.54	365.82	370.06	380.18	386.96

Shipments of More Than 150 Pounds

Zones	32	33	34	35	36	37	38
Shipments of 151 to 199 Pounds							
Price Per Pound	\$2.39	\$2.41	\$2.44	\$2.44	\$2.47	\$2.54	\$2.58
Minimum Rate	357.07	360.96	364.54	365.82	370.06	380.18	386.96
Shipments of 200 Pounds or More							
Price Per Pound	\$2.32	\$2.34	\$2.37	\$2.37	\$2.40	\$2.46	\$2.50
Minimum Rate	475.61	479.59	485.56	485.56	491.53	505.46	513.42

*Visit [ups.com/holidays](https://www.ups.com/holidays) for time-in-transit changes effective during the holiday season.

Note: For additional information, refer to pages [28](#) and [78](#).

Import Shipment Pricing

UPS Worldwide Express Plus[®], UPS Worldwide Express NA1[®], UPS Worldwide Express[®], UPS Worldwide Express Freight[®] Midday, UPS Worldwide Express Freight[®], UPS Worldwide Saver[®], UPS Worldwide Expedited[®], UPS 3 Day Select[®] from Canada and UPS[®] Standard

Shipment pricing is advantageous because rates are based on the total weight of a shipment, not the sum of the rates for each package in a shipment.

What Qualifies

1. The shipment consists of multiple packages, using the same service, shipped on the same day to a single consignee.
2. For shipments processed with WorldShip[®] or UPS CampusShip[®] shipping systems, ups.com shipping, the UPS[®] Developer Kit or a UPS Ready[®] solution that supports full international service or a UPS Worldwide Services Waybill. **Note:** For shipments processed with UPS Developer Kit – Shipping API, in order to obtain the best rate, customers are responsible for aggregating shipments for shipment pricing prior to requesting labels (UPS Developer Kit – Shipping API does not run End of Day).

What Does Not Qualify

Shipment pricing does not apply to UPS Express[®] Envelopes, the UPS[®] 10 KG Box or the UPS[®] 25 KG Box; they are each considered separate shipments.

Rates

Rates are based on the total billable weight of all packages in the shipment. Compare each package's actual weight to its dimensional weight. The greater of the two is the billable weight and should be used to calculate the rate. For multiple-package shipments, total the billable weight of all packages in the shipment. Refer to pages 18-19 for instructions on calculating dimensional weight.

If the payer of the shipping charges is located in the origin country, the shipment will be charged the export rate (Origin Country Export Rates). When

the payer of the shipping charges is located in the destination country, the shipment will be charged the import rate (Destination Country Import Rates). If the destination country does not have import rates, the shipment will be charged the export rate (Origin Country Export Rates). When the payer of the shipping charges is located in a third country (neither origin nor destination country), the shipment will be charged the Origin Country Export Rates, except as otherwise agreed to by UPS and the contracting party.

Unless otherwise specified at the time of shipping, shipping charges are billed to the shipper. In the event of non-payment by consignee or third party, the charges are billed to the shipper. Refer to pages 147-149 for more information on billing options.

For shipments weighing 150 pounds or less, locate the rate for the total weight of the shipment on the appropriate rate chart.

To determine the rate for a shipment weighing more than 150 pounds, multiply the total weight (rounded to the next whole pound) by the appropriate price per pound as shown under the shipment weight designations above 150 pounds. The amount billed will be the result of this calculation or the minimum rate shown, whichever is greater.

For a multiple-package UPS Standard shipment, the minimum charge will be based on an average weight of 15 pounds per package.

All rates for UPS international services, except UPS[®] Standard from Canada, include routine, in-house customs brokerage. For more information on customs brokerage for import shipments, refer to pages 137-139.

Useful Information – International Shipping	
Import/Export Support Information on international shipping and trade	Visit ups.com/international
Shipping Forms Import/export documents	Visit ups.com/intl_forms
UPS Paperless[®] Invoice Send Commercial Invoices and other customs documents electronically, saving time and paper	Visit International Tools and Resources
UPS TradeAbility[®] Services Harmonizer, landed cost and compliance tools	Visit UPS TradeAbility Services
International Customer Service Assistance with international shipments	Call 1-800-782-7892
UPS Import Control[®] Services Take control of your imports	Visit UPS Import Control

Import

UPS Worldwide Express®

UPS Worldwide Express Plus®

Guaranteed delivery as early as 8:00 a.m. or 8:30 a.m. on the next business day from Canada and one to two business days from Asia, Europe and Latin America. Delivery from all valid UPS origins. Rates include door-to-door delivery with routine, in-house customs clearance by UPS Supply Chain Solutions®. Add \$40.00 to the appropriate UPS Worldwide Express rate for each UPS Worldwide Express Plus shipment.

UPS Worldwide Express NA1®

Overnight delivery to the U.S., Canada and Latin America from select cities in Germany, the United Kingdom and the Netherlands. Guaranteed delivery by 10:30 a.m. or 12 p.m. where UPS Worldwide Express service is available or end of day if UPS Worldwide Saver® is the only available service to the destination postal code. UPS Worldwide Express rates apply, which include door-to-door delivery with routine, in-house customs clearance by UPS Supply Chain Solutions. Service requires an early pickup at origin.

UPS Worldwide Express

Guaranteed delivery as early as 10:30 a.m., 12:00 p.m. or 2:00 p.m. from all valid UPS origins. Delivery is guaranteed on the next business day from Canada and Mexico and one to two business days from Asia, Europe and Latin America. Rates include door-to-door delivery with routine, in-house customs clearance by UPS Supply Chain Solutions.

Letter/Document

Zones	91	94	951	952	953	954	955	956	957	958	959	961	962	963	970	971
Letter*	\$63.79	\$65.44	\$113.08	\$93.76	\$120.06	\$95.74	\$131.16	\$91.89	\$109.77	\$117.10	\$100.69	\$108.29	\$86.63	\$100.70	\$88.22	\$86.26
1 Lbs.	93.00	70.32	131.90	104.36	154.90	120.60	150.03	105.53	139.84	147.21	129.11	117.88	104.95	127.44	102.07	104.34
2	94.74	71.05	134.15	107.61	157.54	124.99	189.78	133.11	167.28	186.02	133.35	143.70	114.91	143.21	104.90	131.63
3	129.86	99.49	202.34	167.38	232.93	194.95	323.17	194.91	242.62	292.77	205.55	200.30	191.85	201.18	156.27	172.19
4	142.74	107.65	228.15	184.32	258.36	220.08	372.40	224.00	270.95	351.91	232.85	227.56	221.25	227.89	177.31	197.73
5	155.73	116.44	255.00	201.29	283.82	245.86	421.58	256.71	308.54	384.56	254.16	265.08	243.03	248.74	191.09	222.54
6	174.17	123.94	275.48	220.74	313.38	268.84	468.68	284.70	336.65	429.48	275.24	287.14	269.13	269.37	211.77	240.82
7	182.61	133.40	292.76	237.48	337.90	292.11	517.08	309.49	366.63	480.51	298.59	316.31	294.55	292.23	228.97	263.99
8	195.29	137.71	311.56	253.93	359.54	316.42	573.63	337.81	395.85	531.93	322.56	337.14	318.23	315.67	243.71	282.64
9	207.40	144.60	325.80	270.44	384.66	340.77	609.93	363.06	421.00	577.70	347.56	363.53	342.35	340.15	259.78	305.64
10	219.85	149.92	335.05	286.92	407.72	349.89	634.78	377.39	451.45	627.65	359.26	384.04	358.24	351.60	275.80	310.21

Non-document

Zones	91	94	951	952	953	954	955	956	957	958	959	961	962	963	970	971
1 Lbs.	\$109.09	\$82.38	\$191.50	\$130.54	\$204.18	\$165.32	\$232.20	\$147.29	\$193.90	\$208.08	\$170.56	\$177.72	\$156.11	\$167.40	\$121.57	\$133.04
2	123.48	92.34	218.51	156.43	233.40	192.51	277.83	176.70	226.01	250.54	194.62	208.37	180.08	192.55	146.23	154.31
3	137.67	103.18	239.78	174.69	257.55	222.50	336.88	203.09	270.30	311.08	226.80	235.28	204.67	222.59	163.03	176.27
4	151.01	111.64	268.46	192.75	295.23	254.41	388.45	233.62	311.32	358.51	250.22	262.03	228.83	245.59	180.17	199.47
5	164.36	120.77	291.28	211.10	318.91	280.66	439.77	265.34	342.84	398.41	273.22	286.34	251.26	268.14	196.98	225.92
6	178.28	128.55	310.27	226.85	339.32	309.13	488.85	293.46	371.18	442.88	296.18	307.61	277.02	290.68	216.96	244.70
7	187.54	137.71	327.66	244.20	359.75	337.78	539.35	322.62	399.52	498.21	315.48	330.43	302.64	309.61	229.10	267.54
8	200.21	142.83	344.77	262.11	387.45	365.46	598.33	348.23	428.82	541.96	336.81	363.90	328.21	330.55	245.21	286.62
9	212.62	149.95	360.14	278.21	412.36	389.94	636.19	374.49	457.06	593.32	361.63	386.81	353.83	354.90	263.80	309.47
10	225.80	154.98	367.93	295.66	438.62	392.63	651.34	389.05	488.19	650.77	373.34	401.63	374.58	366.40	277.37	314.07

*The Letter rate applies only to documents, correspondence and electronic media shipments of no commercial value that do not exceed eight ounces and are sent in a UPS Express® Envelope.

Note: For additional information, refer to page 28.

Import

UPS Worldwide Express®

Non-document

Zones	91	94	951	952	953	954	955	956	957	958	959	961	962	963	970	971
11 Lbs.	\$238.76	\$159.09	\$368.72	\$297.86	\$449.46	\$395.44	\$664.72	\$392.60	\$514.76	\$652.62	\$374.17	\$416.16	\$376.55	\$367.23	\$279.26	\$318.11
12	244.40	159.43	371.56	300.07	454.78	405.74	672.82	395.90	532.22	662.25	377.83	419.89	389.34	376.23	288.73	320.65
13	257.13	180.96	426.43	344.19	523.08	478.95	809.67	459.67	572.07	757.53	441.62	471.90	451.77	433.41	322.33	362.92
14	271.46	188.56	442.26	360.21	536.40	505.28	848.45	479.40	599.35	777.12	468.46	492.79	485.59	459.75	333.58	384.79
15	280.89	192.75	456.47	376.26	558.33	536.37	886.37	507.98	626.04	814.46	487.55	515.72	510.66	478.49	351.67	403.64
16	288.74	201.92	472.34	391.63	581.20	553.92	919.60	525.05	656.35	861.09	502.24	524.57	541.85	492.90	366.00	427.06
17	298.94	208.38	486.58	406.94	604.13	578.49	955.82	533.58	683.03	888.71	521.72	543.87	549.59	512.03	380.46	442.54
18	307.42	218.33	500.83	422.31	627.02	598.91	986.54	554.04	708.47	920.15	531.50	566.80	587.98	521.61	391.01	463.61
19	316.24	220.04	515.10	437.67	664.85	621.41	1,027.60	568.33	735.79	947.69	553.02	584.51	612.87	542.75	405.01	480.84
20	325.95	224.61	527.46	453.04	672.82	637.94	1,053.52	582.59	755.30	957.53	563.87	605.30	640.13	553.38	419.32	499.68
21	332.12	230.97	536.18	468.22	711.74	644.25	1,053.99	589.49	787.91	1,010.41	575.45	608.27	661.98	564.76	437.21	507.56
22	340.27	235.68	536.23	480.29	718.63	644.82	1,055.81	593.63	814.26	1,026.13	575.79	611.25	670.19	565.09	448.61	509.56
23	348.33	236.15	536.28	480.98	734.91	645.52	1,059.49	598.71	834.24	1,026.75	604.23	624.15	670.61	593.01	449.11	522.67
24	353.04	236.43	536.33	481.79	736.53	649.43	1,059.91	599.30	860.15	1,027.44	604.57	626.39	673.37	593.34	460.56	537.57
25	354.93	238.67	539.60	484.45	742.43	667.17	1,067.90	603.31	871.25	1,050.84	609.18	630.79	689.17	600.10	462.58	540.50
26	369.91	266.58	611.29	533.20	806.63	769.66	1,227.67	657.41	913.87	1,128.35	651.22	707.42	768.68	639.12	497.86	580.04
27	376.08	279.18	627.49	557.30	828.63	827.56	1,254.54	699.45	938.47	1,167.95	664.73	728.10	796.68	652.38	520.94	618.32
28	384.25	286.57	641.43	572.01	870.20	834.76	1,281.36	715.62	961.98	1,177.65	678.15	743.39	816.69	665.54	534.64	633.15
29	391.50	294.01	653.00	586.68	892.60	856.98	1,319.31	740.85	983.21	1,229.71	698.79	760.10	846.18	685.80	548.20	648.04
30	399.08	295.81	666.86	601.41	894.87	871.39	1,344.57	756.33	1,003.98	1,249.02	714.00	775.92	859.77	700.73	561.90	662.27
31	406.51	304.82	680.68	614.78	909.31	890.63	1,367.70	763.96	1,022.32	1,255.30	728.96	793.13	863.30	715.41	574.53	675.87
32	413.67	311.54	692.06	628.17	945.21	899.04	1,397.90	790.49	1,038.03	1,257.26	735.93	812.95	896.67	722.25	587.06	690.13
33	419.66	314.02	700.91	630.28	951.47	942.95	1,424.54	805.29	1,053.43	1,295.96	749.80	826.19	909.77	735.86	589.01	701.64
34	425.72	320.09	712.26	654.14	953.33	947.89	1,442.23	810.12	1,067.65	1,331.26	765.57	839.24	937.12	751.34	611.34	715.71
35	431.70	329.54	725.17	659.64	990.26	973.12	1,469.01	825.62	1,080.18	1,380.71	776.70	849.86	965.49	762.26	616.31	727.22
36	437.71	335.08	737.45	681.65	1,001.28	1,003.16	1,495.82	841.20	1,092.84	1,387.58	783.12	871.57	986.00	768.56	637.04	743.23
37	444.71	341.95	748.99	695.02	1,002.42	1,025.04	1,525.83	856.70	1,105.07	1,394.96	796.83	886.87	988.96	782.01	649.57	757.78
38	445.42	348.34	760.42	707.90	1,024.53	1,056.26	1,549.43	873.91	1,118.65	1,418.25	833.09	903.75	1,007.43	817.59	661.45	770.42
39	455.72	354.57	771.77	712.53	1,026.75	1,078.91	1,582.66	889.48	1,131.48	1,437.89	864.00	927.23	1,035.60	847.93	665.85	784.03
40	461.72	360.60	783.14	722.21	1,041.42	1,100.58	1,608.29	912.19	1,143.86	1,473.32	877.84	944.27	1,044.35	861.52	674.96	797.30
41	467.16	363.93	794.27	747.56	1,078.81	1,122.71	1,631.85	927.85	1,168.15	1,498.00	898.20	956.00	1,066.84	881.52	698.03	810.25
42	472.66	373.03	805.34	761.30	1,092.34	1,138.97	1,657.51	949.78	1,180.68	1,527.01	917.93	970.19	1,081.29	900.87	711.47	823.71
43	482.10	379.40	816.41	762.27	1,101.79	1,188.10	1,684.06	960.05	1,194.71	1,545.21	928.39	986.31	1,099.76	911.14	711.77	837.15
44	483.67	385.46	827.47	784.13	1,102.73	1,199.53	1,706.23	974.86	1,206.76	1,554.63	960.08	1,002.05	1,103.02	942.24	733.27	849.59
45	489.20	392.34	838.65	785.93	1,107.42	1,201.15	1,735.47	980.32	1,220.51	1,585.67	967.19	1,018.58	1,168.01	949.21	733.84	863.21
46	494.71	398.22	849.71	799.18	1,142.15	1,233.45	1,770.52	1,006.62	1,244.05	1,638.55	967.81	1,027.28	1,176.39	949.81	749.37	874.71
47	500.22	404.61	857.67	826.55	1,149.63	1,249.14	1,804.18	1,011.15	1,258.09	1,643.84	968.21	1,042.64	1,177.90	950.22	777.64	886.89
48	505.71	406.07	871.89	833.19	1,151.22	1,285.17	1,830.08	1,026.58	1,271.36	1,646.29	969.25	1,072.36	1,207.50	951.24	779.54	901.10
49	508.31	415.41	873.29	851.12	1,182.77	1,299.93	1,857.11	1,041.98	1,283.75	1,695.12	989.49	1,075.21	1,210.46	971.10	790.94	911.99
50	509.00	421.15	874.72	857.63	1,185.92	1,322.03	1,881.45	1,057.41	1,297.80	1,774.21	1,004.31	1,093.73	1,228.97	985.65	793.16	925.89

Note: For additional information, refer to page 28.

Import

UPS Worldwide Express®

Non-document

Zones	91	94	951	952	953	954	955	956	957	958	959	961	962	963	970	971
52 Lbs.	\$524.91	\$440.91	\$928.82	\$889.36	\$1,246.21	\$1,373.76	\$1,935.36	\$1,103.85	\$1,333.49	\$1,850.94	\$1,057.25	\$1,138.36	\$1,322.07	\$1,037.60	\$822.49	\$945.58
54	529.63	442.19	935.02	915.27	1,249.75	1,410.55	1,995.55	1,118.44	1,365.75	1,903.90	1,097.13	1,172.11	1,346.42	1,076.74	847.85	972.12
56	546.24	456.06	957.15	940.00	1,264.39	1,448.33	2,047.92	1,155.47	1,397.05	1,906.16	1,110.62	1,204.13	1,373.85	1,089.97	879.63	998.02
58	563.16	469.90	979.29	964.74	1,279.00	1,486.11	2,101.22	1,196.27	1,426.98	1,908.43	1,152.06	1,236.28	1,401.29	1,130.64	902.67	1,023.62
60	565.88	483.70	1,001.30	989.56	1,330.92	1,544.53	2,147.81	1,209.94	1,456.17	1,919.75	1,197.14	1,265.01	1,492.84	1,174.89	925.89	1,049.41
62	587.37	498.86	1,031.89	997.93	1,335.74	1,586.23	2,201.30	1,254.35	1,485.63	1,987.55	1,240.20	1,296.34	1,535.51	1,217.15	931.80	1,076.27
64	600.76	521.26	1,046.84	1,047.74	1,356.50	1,633.48	2,254.36	1,279.28	1,517.25	2,055.40	1,271.55	1,333.03	1,563.94	1,247.91	978.31	1,102.64
66	612.83	529.66	1,077.68	1,050.39	1,413.78	1,671.54	2,327.00	1,301.16	1,546.17	2,109.32	1,274.00	1,365.02	1,594.14	1,250.32	980.78	1,110.03
68	615.24	557.29	1,088.68	1,069.38	1,418.03	1,708.98	2,362.37	1,337.05	1,575.89	2,112.22	1,275.14	1,397.38	1,683.46	1,251.43	998.52	1,131.43
70	635.06	572.85	1,109.64	1,093.17	1,454.32	1,742.15	2,426.71	1,374.83	1,605.36	2,157.95	1,356.92	1,429.36	1,715.95	1,331.70	1,020.72	1,180.24
72	651.37	588.35	1,146.87	1,134.71	1,458.70	1,787.35	2,472.57	1,412.80	1,636.53	2,227.29	1,403.74	1,469.71	1,718.75	1,377.64	1,061.57	1,229.49
74	664.09	601.98	1,148.76	1,140.86	1,513.37	1,831.44	2,574.69	1,438.59	1,663.99	2,277.90	1,413.42	1,492.31	1,765.52	1,387.14	1,065.24	1,252.71
76	676.67	609.51	1,157.47	1,183.12	1,532.20	1,874.03	2,628.79	1,448.23	1,701.75	2,326.26	1,444.77	1,538.94	1,860.53	1,417.90	1,106.91	1,259.75
78	689.82	620.47	1,187.73	1,201.62	1,535.40	1,916.59	2,657.11	1,475.94	1,726.46	2,439.84	1,488.52	1,592.52	1,903.37	1,460.84	1,121.98	1,270.00
80	691.53	635.62	1,204.19	1,234.01	1,590.90	1,959.31	2,712.42	1,500.76	1,756.55	2,497.94	1,521.25	1,617.19	1,910.58	1,492.97	1,152.23	1,296.39
82	697.52	658.24	1,228.14	1,255.08	1,602.83	2,002.73	2,777.39	1,528.91	1,790.03	2,539.62	1,541.53	1,643.61	1,969.07	1,512.88	1,172.69	1,322.63
84	707.90	667.60	1,247.66	1,265.11	1,633.31	2,040.34	2,830.44	1,544.91	1,820.18	2,603.27	1,585.04	1,664.88	1,973.26	1,555.58	1,181.26	1,347.60
86	720.74	694.50	1,262.55	1,287.24	1,647.98	2,064.89	2,837.33	1,549.27	1,852.15	2,653.93	1,633.34	1,692.55	2,031.82	1,602.99	1,201.96	1,373.51
88	730.66	695.26	1,293.55	1,310.33	1,670.56	2,065.77	2,888.17	1,556.63	1,890.86	2,658.61	1,634.17	1,712.75	2,073.49	1,603.79	1,223.49	1,398.93
90	739.90	702.76	1,326.53	1,312.25	1,672.83	2,078.48	2,957.97	1,572.35	1,921.12	2,729.28	1,666.86	1,746.17	2,141.71	1,635.88	1,225.30	1,419.72
92	751.03	716.82	1,337.45	1,324.63	1,673.53	2,095.96	2,995.55	1,618.59	1,922.99	2,741.16	1,720.41	1,792.87	2,153.45	1,688.42	1,236.86	1,440.21
94	761.27	719.26	1,345.36	1,341.02	1,674.31	2,112.57	3,011.40	1,634.62	1,966.17	2,746.73	1,740.10	1,805.20	2,172.33	1,707.74	1,258.72	1,461.31
96	771.22	742.62	1,361.81	1,358.70	1,679.96	2,125.48	3,067.86	1,650.78	2,005.68	2,874.20	1,743.56	1,825.39	2,193.38	1,711.15	1,268.66	1,487.88
98	783.55	749.48	1,387.52	1,370.27	1,682.48	2,127.24	3,127.51	1,652.67	2,031.18	2,884.81	1,762.48	1,839.34	2,221.64	1,729.72	1,314.15	1,511.70
100	796.02	785.30	1,439.50	1,484.10	1,761.95	2,127.85	3,170.51	1,698.44	2,072.39	2,887.39	1,805.19	1,895.30	2,233.60	1,771.62	1,335.46	1,536.26
105	832.67	849.43	1,511.55	1,554.44	1,850.73	2,287.53	3,334.87	1,779.83	2,181.01	3,030.94	1,924.74	1,990.54	2,355.65	1,888.96	1,430.74	1,599.84
110	870.13	889.88	1,583.53	1,628.48	1,936.87	2,396.45	3,487.11	1,864.34	2,281.55	3,172.15	1,997.35	2,080.41	2,467.81	1,960.23	1,531.41	1,662.31
115	911.38	930.33	1,655.49	1,702.48	2,024.25	2,505.37	3,641.58	1,947.88	2,359.90	3,313.63	2,108.01	2,172.88	2,580.00	2,068.82	1,596.53	1,732.91
120	946.78	970.78	1,727.48	1,776.51	2,107.61	2,598.06	3,798.90	2,031.41	2,438.70	3,454.43	2,188.57	2,278.67	2,691.83	2,147.89	1,665.85	1,807.18
125	982.09	1,011.21	1,799.45	1,850.52	2,192.22	2,705.69	3,960.90	2,113.16	2,518.45	3,597.36	2,278.15	2,389.48	2,802.74	2,235.80	1,734.88	1,876.05
130	1,017.06	1,051.68	1,871.42	1,924.53	2,290.78	2,808.36	4,116.42	2,197.69	2,596.80	3,739.71	2,362.59	2,476.78	2,896.29	2,318.68	1,804.03	1,942.82
135	1,053.58	1,092.10	1,943.41	1,998.55	2,372.89	2,912.05	4,272.78	2,280.55	2,674.54	3,882.68	2,442.28	2,567.63	2,976.90	2,396.88	1,873.23	2,011.85
140	1,087.77	1,132.56	2,015.36	2,072.59	2,453.47	3,016.42	4,428.99	2,364.44	2,774.09	4,024.44	2,527.99	2,649.81	3,066.39	2,481.00	1,941.96	2,081.68
145	1,123.75	1,172.99	2,087.34	2,146.59	2,536.97	3,121.99	4,583.90	2,449.43	2,852.27	4,166.40	2,616.02	2,732.19	3,164.70	2,567.40	2,011.26	2,149.70
150	1,179.47	1,208.39	2,159.32	2,220.62	2,618.80	3,225.17	4,738.97	2,534.27	2,930.79	4,304.69	2,689.99	2,825.31	3,276.86	2,639.98	2,069.41	2,220.50

Shipments of More Than 150 Pounds (non-pallet)

Zones	91	94	951	952	953	954	955	956	957	958	959	961	962	963	970	971
Price Per Pound	\$7.87	\$8.06	\$14.40	\$14.81	\$17.46	\$21.51	\$31.60	\$16.90	\$19.54	\$28.70	\$17.94	\$18.84	\$21.85	\$17.60	\$13.80	\$14.81
Minimum Rate	1,179.47	1,208.39	2,159.32	2,220.62	2,618.80	3,225.17	4,738.97	2,534.27	2,930.79	4,304.69	2,689.99	2,825.31	3,276.86	2,639.98	2,069.41	2,220.50

Note: For additional information, refer to page 28.

Import

UPS Worldwide Express Freight® Midday

Guaranteed delivery by 12:00 p.m. or 2:00 p.m. from 85 countries and territories. Delivery is guaranteed on the next business day to Canada, the second business day to Europe and Latin America, and within two to three business days to Asia. Rates include door-to-door and non-door-to-door delivery with routine, in-house customs clearance by UPS Supply Chain Solutions for palletized shipments of more than 150 pounds.

Door-to-Door

Zones	491	494	451	452	453	454	455
151-999 Lbs. (Price per Lb.)	\$8.60	\$9.58	\$16.92	\$16.91	\$20.72	\$24.35	\$32.96
1,000 Lbs. or More (Price per Lb.)	8.17	9.19	16.28	16.12	19.89	23.39	31.67
Minimum Rate	1,298.60	1,446.58	2,554.92	2,553.41	3,128.72	3,676.85	4,976.96

Zones	456	457	458	459	461	462	463	470	471
151-999 Lbs. (Price per Lb.)	\$18.96	\$21.65	\$32.89	\$21.19	\$21.12	\$25.16	\$20.53	\$15.84	\$17.87
1,000 Lbs. or More (Price per Lb.)	18.16	20.51	31.57	20.40	20.23	24.20	19.75	15.09	16.92
Minimum Rate	2,862.96	3,269.15	4,966.39	3,199.69	3,189.12	3,799.16	3,100.03	2,391.84	2,698.37

Non-Door-to-Door: Drop-off, Hold at Location, Drop-off and Hold at Location

Zones	491	494	451	452	453	454	455
151-999 Lbs. (Price per Lb.)	\$8.26	\$9.20	\$16.56	\$16.43	\$20.24	\$23.87	\$32.52
1,000 Lbs. or More (Price per Lb.)	7.83	8.81	15.92	15.64	19.41	22.91	31.23
Minimum Rate	1,247.26	1,389.20	2,500.56	2,480.93	3,056.24	3,604.37	4,910.52

Zones	456	457	458	459	461	462	463	470	471
151-999 Lbs. (Price per Lb.)	\$18.50	\$21.31	\$32.43	\$20.81	\$20.64	\$24.66	\$20.15	\$15.38	\$17.41
1,000 Lbs. or More (Price per Lb.)	17.70	20.17	31.11	20.02	19.75	23.70	19.38	14.63	16.46
Minimum Rate	2,793.50	3,217.81	4,896.93	3,142.31	3,116.64	3,723.66	3,042.65	2,322.38	2,628.91

Notes:

- Door-to-door refers to shipments picked up and delivered to addresses designated by the shipper.
- Drop-off refers to shipments that are dropped off at a UPS Worldwide Express Freight Center and delivered to a designated address.
- Hold at Location refers to shipments picked up at a designated address and held at a UPS Worldwide Express Freight Center for pickup.
- Drop-off and Hold at Location refers to shipments that are dropped off and held at a UPS Worldwide Express Freight Center for pickup.
- For UPS Worldwide Express Freight Midday shipments, additional charges may apply to larger pallets. Pallets exceeding maximum size or weight restrictions (which vary by origin and destination) as set forth at [ups.com/assets/resources/media/wwf_max_dim.pdf](https://www.ups.com/assets/resources/media/wwf_max_dim.pdf) require prior authorization. Refer to page 129 for more information.
- For additional information, refer to page 28.

Import

UPS Worldwide Express Freight®

Guaranteed delivery by end of day from 85 countries and territories. Delivery is guaranteed on the next business day from Canada and Mexico and one to two business days from Asia, Europe and Latin America. Rates include door-to-door and non-door-to-door delivery with routine, in-house customs clearance by UPS Supply Chain Solutions for palletized shipments of more than 150 pounds.

Door-to-Door

Zones	491	494	451	452	453	454	455
151-999 Lbs. (Price per Lb.)	\$7.48	\$7.66	\$14.10	\$14.09	\$17.27	\$20.29	\$29.96
1,000 Lbs. or More (Price per Lb.)	7.11	7.35	13.57	13.43	16.58	19.49	28.79
Minimum Rate	1,129.48	1,156.66	2,129.10	2,127.59	2,607.77	3,063.79	4,523.96

Zones	456	457	458	459	461	462	463	470	471
151-999 Lbs. (Price per Lb.)	\$16.49	\$18.83	\$28.60	\$16.95	\$17.60	\$20.13	\$16.42	\$13.77	\$15.54
1,000 Lbs. or More (Price per Lb.)	15.79	17.84	27.45	16.32	16.86	19.36	15.80	13.12	14.71
Minimum Rate	2,489.99	2,843.33	4,318.60	2,559.45	2,657.60	3,039.63	2,479.42	2,079.27	2,346.54

Non-Door-to-Door: Drop-off, Hold at Location,
Drop-off and Hold at Location

Zones	491	494	451	452	453	454	455
151-999 Lbs. (Price per Lb.)	\$7.18	\$7.36	\$13.80	\$13.69	\$16.87	\$19.89	\$29.56
1,000 Lbs. or More (Price per Lb.)	6.81	7.05	13.27	13.03	16.18	19.09	28.39
Minimum Rate	1,084.18	1,111.36	2,083.80	2,067.19	2,547.37	3,003.39	4,463.56

Zones	456	457	458	459	461	462	463	470	471
151-999 Lbs. (Price per Lb.)	\$16.09	\$18.53	\$28.20	\$16.65	\$17.20	\$19.73	\$16.12	\$13.37	\$15.14
1,000 Lbs. or More (Price per Lb.)	15.39	17.54	27.05	16.02	16.46	18.96	15.50	12.72	14.31
Minimum Rate	2,429.59	2,798.03	4,258.20	2,514.15	2,597.20	2,979.23	2,434.12	2,018.87	2,286.14

Notes:

- Door-to-door refers to shipments picked up and delivered to addresses designated by the shipper.
- Drop-off refers to shipments that are dropped off at a UPS Worldwide Express Freight Center and delivered to a designated address.
- Hold at Location refers to shipments picked up at a designated address and held at a UPS Worldwide Express Freight Center for pickup.
- Drop-off and Hold at Location refers to shipments that are dropped off and held at a UPS Worldwide Express Freight Center for pickup.
- For UPS Worldwide Express Freight shipments, additional charges may apply to larger pallets. Pallets exceeding maximum size or weight restrictions (which vary by origin and destination) as set forth at [ups.com/assets/resources/media/wwef_max_dim.pdf](https://www.ups.com/assets/resources/media/wwef_max_dim.pdf) require prior authorization. Refer to page 129 for more information.
- For additional information, refer to page 28.

Import

UPS Worldwide Saver®

Guaranteed delivery by end of day from more than 185 countries and territories. Delivery is guaranteed on the next business day from Canada and Mexico and one to two business days from Asia, Europe and Latin America. Rates include door-to-door delivery with routine, in-house customs clearance by UPS Supply Chain Solutions.

Letter/Document

Zones	491	494	451	452	453	454	455	456	457	458	459	461	462	463	470	471
Letter*	\$62.66	\$64.78	\$111.37	\$89.56	\$118.34	\$92.18	\$125.14	\$90.30	\$105.36	\$114.44	\$93.38	\$104.04	\$86.52	\$93.71	\$83.44	\$82.66
1 Lbs.	87.65	68.59	129.85	99.31	151.58	115.70	141.50	103.48	132.26	137.13	124.51	112.76	102.71	123.43	94.06	98.42
2	91.49	69.30	131.77	101.19	154.07	119.02	175.52	130.56	158.44	172.63	128.35	138.84	112.14	137.58	98.77	120.45
3	127.26	96.86	198.87	161.44	230.05	188.42	314.11	191.77	237.63	292.58	194.21	189.96	186.43	192.54	145.62	160.71
4	139.90	104.80	224.26	177.79	255.19	212.76	361.95	220.41	265.37	351.68	220.00	215.81	214.98	218.09	165.64	188.62
5	152.63	113.35	250.65	194.14	280.32	237.71	409.78	252.59	302.19	384.01	240.18	251.40	236.19	238.11	180.32	212.70
6	165.12	120.65	270.75	212.91	309.54	260.74	455.53	280.13	329.72	426.87	263.40	272.33	260.56	261.11	202.14	231.02
7	177.28	129.85	287.77	229.06	333.75	285.18	502.59	304.54	359.10	480.21	285.82	300.01	285.11	283.36	219.40	252.71
8	189.27	134.07	306.26	244.92	355.11	308.73	557.57	332.40	387.69	531.60	308.76	319.75	308.29	306.10	231.11	270.42
9	201.34	140.76	320.24	260.85	379.93	332.79	592.84	357.24	412.35	577.33	332.70	344.77	332.50	329.82	248.40	292.40
10	213.43	145.93	329.34	276.73	402.71	341.44	617.01	371.33	442.17	627.24	343.82	364.24	348.03	340.85	265.93	292.90

Non-document

Zones	491	494	451	452	453	454	455	456	457	458	459	461	462	463	470	471
1 Lbs.	\$104.49	\$80.59	\$187.09	\$122.64	\$201.86	\$160.09	\$223.25	\$144.69	\$188.35	\$207.95	\$157.18	\$163.24	\$149.27	\$160.02	\$113.29	\$124.19
2	118.35	90.32	213.49	146.93	230.75	187.51	266.94	173.71	220.01	250.37	184.56	192.43	170.69	182.96	134.82	147.58
3	131.95	100.94	234.28	164.09	254.63	216.74	323.69	199.51	262.37	307.68	211.13	217.15	194.37	209.30	151.96	168.98
4	145.05	109.20	262.31	181.03	291.90	247.75	373.50	229.24	300.90	355.05	233.40	241.87	217.06	231.40	167.47	191.96
5	158.27	118.13	284.63	198.31	315.30	273.38	422.67	260.76	331.30	398.14	254.24	265.13	238.67	252.04	184.77	218.15
6	171.20	125.75	303.16	214.04	335.50	301.11	470.07	289.06	358.67	442.59	277.36	280.82	263.40	274.96	205.70	236.17
7	183.81	134.72	320.16	230.27	355.70	329.00	518.63	317.32	386.17	497.90	295.84	308.17	287.32	293.28	220.06	258.44
8	196.22	139.71	336.89	246.21	383.08	355.87	569.52	342.63	415.53	535.79	314.83	336.32	311.24	312.11	232.22	276.97
9	208.40	146.68	351.91	262.24	407.70	379.82	611.76	368.23	443.04	592.06	338.14	357.64	335.46	335.22	252.11	298.88
10	221.31	151.61	359.52	278.21	433.66	382.32	621.38	382.76	473.17	650.37	348.51	373.78	354.31	345.50	266.16	300.03
11	233.11	152.62	362.14	282.74	444.39	387.97	632.60	386.20	499.08	652.21	355.31	379.50	360.16	349.94	268.45	300.63
12	235.44	154.01	364.94	284.82	447.88	396.59	644.58	389.44	515.07	657.40	368.85	386.24	373.77	361.69	276.66	309.82
13	251.03	177.03	418.85	326.73	517.17	469.92	771.70	452.20	554.64	746.38	421.63	442.88	430.69	410.70	307.09	350.51
14	265.03	184.46	434.39	341.95	530.35	491.94	808.66	471.61	581.04	776.62	446.05	460.08	453.94	434.48	319.30	371.34
15	274.23	188.55	448.35	357.18	552.05	518.91	844.64	496.43	606.81	813.93	461.34	483.39	477.46	449.37	338.10	390.12
16	281.91	197.52	463.94	371.76	574.66	535.85	875.20	513.08	636.29	845.33	477.98	492.41	506.23	465.57	352.28	412.52
17	291.86	203.84	477.93	386.29	597.32	559.63	909.67	524.79	662.07	878.59	493.29	505.59	523.79	480.49	365.35	427.65
18	300.14	213.57	491.93	400.91	619.96	579.58	938.90	542.24	682.78	906.56	503.81	528.49	552.19	490.74	373.94	448.16
19	308.75	215.25	505.94	415.48	657.35	601.03	979.19	555.41	707.99	940.24	519.78	548.66	575.44	506.31	387.64	464.68
20	318.23	219.73	518.07	430.07	665.24	617.15	1,002.66	572.21	729.11	956.93	535.19	564.13	601.02	521.31	401.44	482.81

*The Letter rate applies only to documents, correspondence and electronic media shipments of no commercial value that do not exceed eight ounces and are sent in a UPS Express® Envelope.

Note: For additional information, refer to page 28.

Import

UPS Worldwide Saver®

Non-document

Zones	491	494	451	452	453	454	455	456	457	458	459	461	462	463	470	471
21 Lbs.	\$324.25	\$225.94	\$523.61	\$444.59	\$703.72	\$617.60	\$1,004.43	\$579.61	\$763.80	\$991.50	\$542.83	\$565.71	\$614.54	\$528.76	\$420.56	\$490.80
22	332.22	230.53	529.05	455.96	710.52	618.80	1,006.34	579.89	775.47	1,025.48	546.09	570.71	618.61	537.89	430.59	492.54
23	340.09	231.01	529.34	457.09	726.61	627.94	1,008.35	583.26	794.02	1,026.12	547.13	570.99	630.21	554.90	431.55	500.34
24	344.67	231.28	529.62	457.36	728.21	632.96	1,008.98	589.56	812.58	1,026.71	547.41	571.61	634.52	567.71	441.76	519.44
25	346.53	232.98	533.02	459.89	731.53	645.38	1,016.33	593.49	815.02	1,036.82	553.63	576.29	648.96	576.96	442.87	522.23
26	361.17	260.79	598.14	508.41	797.54	751.69	1,168.42	646.70	863.38	1,127.64	613.93	655.62	731.44	600.60	477.91	550.37
27	367.19	273.07	613.99	529.06	819.28	783.49	1,193.98	688.05	871.37	1,157.35	632.17	679.51	751.59	616.35	498.03	581.25
28	375.17	280.33	627.64	543.03	860.41	803.56	1,219.50	703.95	911.22	1,176.91	645.28	694.30	770.59	631.83	510.66	595.41
29	382.25	287.61	638.95	556.96	882.54	824.80	1,257.25	723.46	926.88	1,206.92	659.78	709.19	797.46	645.79	522.98	609.61
30	389.65	289.37	652.52	570.94	884.75	846.03	1,281.56	738.51	932.18	1,235.18	673.60	724.01	811.05	659.36	534.09	622.99
31	396.88	298.18	666.05	583.63	899.06	857.05	1,301.70	751.53	960.41	1,254.50	690.45	738.85	830.03	672.55	544.74	635.57
32	403.90	304.75	677.19	596.34	934.53	878.07	1,332.56	771.39	990.32	1,256.47	705.36	753.65	845.83	687.08	556.60	648.97
33	409.73	307.18	685.86	598.35	940.74	903.60	1,355.79	790.08	996.68	1,295.15	718.21	768.49	858.57	699.58	561.15	659.52
34	415.65	313.13	696.96	621.00	942.58	917.61	1,372.61	796.93	998.11	1,330.44	732.87	783.35	884.10	713.87	582.12	673.03
35	421.49	322.34	709.59	626.21	979.09	938.57	1,398.09	812.18	1,026.43	1,355.08	740.56	793.79	916.01	721.35	584.54	683.88
36	427.36	327.78	721.59	647.10	990.00	967.19	1,423.61	827.51	1,035.21	1,379.89	751.03	813.01	931.09	731.55	608.94	699.18
37	434.19	334.49	732.89	659.81	991.12	985.80	1,457.15	842.75	1,053.75	1,394.07	764.18	828.21	932.95	744.36	620.81	712.75
38	434.87	340.75	744.08	672.05	1,012.96	1,007.52	1,474.65	859.69	1,072.32	1,417.34	786.89	844.31	950.41	766.48	630.42	724.56
39	444.94	346.84	755.18	676.43	1,015.16	1,026.99	1,508.46	875.00	1,096.73	1,436.98	797.86	857.47	975.78	777.18	633.38	736.97
40	450.79	352.74	766.32	685.65	1,029.69	1,047.15	1,533.09	895.70	1,108.90	1,472.39	809.68	872.29	985.01	788.67	641.44	749.72
41	456.12	356.01	777.21	712.79	1,066.64	1,067.14	1,557.73	911.25	1,132.58	1,497.04	827.90	883.08	1,006.49	806.43	665.09	762.01
42	461.48	364.91	788.05	722.74	1,080.01	1,087.50	1,582.53	926.78	1,144.59	1,526.04	832.06	897.85	1,020.09	810.48	678.78	774.76
43	470.69	371.15	798.88	723.78	1,089.37	1,122.34	1,608.27	942.17	1,158.11	1,532.01	862.21	912.58	1,037.40	839.85	678.97	787.51
44	472.23	377.06	809.71	744.43	1,090.30	1,135.68	1,628.15	959.00	1,169.92	1,553.65	896.46	923.05	1,054.86	873.21	697.19	799.45
45	477.64	383.79	820.62	746.50	1,094.93	1,156.86	1,657.06	964.35	1,183.48	1,584.69	909.72	928.97	1,097.51	886.14	698.69	811.57
46	483.01	389.54	831.47	758.70	1,129.27	1,177.02	1,690.04	990.23	1,206.23	1,637.51	915.54	951.53	1,109.59	891.79	711.97	822.42
47	488.39	395.79	839.24	784.70	1,136.67	1,198.37	1,722.59	994.67	1,219.74	1,642.81	920.28	965.32	1,110.96	896.42	737.19	834.06
48	493.75	397.23	853.16	787.30	1,138.24	1,211.83	1,746.69	1,009.87	1,232.68	1,645.26	927.82	978.01	1,138.99	903.76	739.41	847.44
49	496.29	406.37	854.55	809.49	1,169.43	1,233.43	1,773.27	1,025.02	1,244.67	1,694.06	938.02	990.99	1,146.89	913.69	749.82	857.81
50	496.96	411.98	855.93	817.51	1,172.55	1,253.81	1,796.00	1,040.19	1,258.04	1,773.11	954.39	1,004.57	1,158.34	929.65	751.10	870.85
52	517.40	423.07	901.12	845.38	1,209.52	1,294.96	1,827.88	1,070.17	1,292.94	1,777.58	987.25	1,059.32	1,216.39	961.65	779.73	889.51
54	518.78	436.80	919.64	868.93	1,235.65	1,337.24	1,879.08	1,100.22	1,323.98	1,886.42	1,024.21	1,079.97	1,265.07	997.66	801.70	914.06
56	533.64	450.51	941.40	892.42	1,250.12	1,377.31	1,944.12	1,136.65	1,354.62	1,903.71	1,053.20	1,109.64	1,295.98	1,025.89	836.99	938.44
58	548.49	464.19	963.18	915.88	1,264.58	1,416.72	2,002.68	1,167.41	1,383.34	1,905.99	1,063.89	1,139.29	1,322.01	1,036.31	858.15	963.00
60	549.97	477.80	984.82	939.46	1,315.90	1,456.18	2,021.85	1,190.25	1,411.67	1,917.28	1,117.43	1,153.72	1,394.04	1,088.45	880.23	986.93

Note: For additional information, refer to page 28.

Import

UPS Worldwide Saver®

Non-document

Zones	491	494	451	452	453	454	455	456	457	458	459	461	462	463	470	471
62 Lbs.	\$569.97	\$492.76	\$1,014.92	\$951.20	\$1,320.68	\$1,495.59	\$2,072.54	\$1,224.10	\$1,440.40	\$1,985.02	\$1,158.04	\$1,182.31	\$1,437.30	\$1,128.00	\$886.26	\$1,012.26
64	580.37	514.92	1,029.63	995.09	1,341.19	1,540.98	2,152.04	1,251.90	1,471.01	2,052.76	1,187.25	1,238.92	1,467.94	1,156.46	924.51	1,037.28
66	590.84	523.19	1,059.96	1,001.36	1,397.84	1,576.82	2,172.38	1,273.04	1,499.02	2,106.61	1,213.06	1,247.30	1,496.59	1,181.60	927.38	1,044.16
68	594.31	543.05	1,070.76	1,019.28	1,402.02	1,611.79	2,240.18	1,305.75	1,527.72	2,109.52	1,222.94	1,287.64	1,566.91	1,191.23	945.01	1,064.51
70	607.64	558.71	1,091.40	1,042.01	1,437.92	1,642.91	2,307.07	1,341.31	1,556.33	2,155.19	1,296.24	1,328.63	1,603.85	1,262.62	967.12	1,109.97
72	623.49	573.75	1,126.90	1,077.27	1,442.26	1,685.56	2,318.23	1,378.45	1,586.63	2,224.44	1,310.47	1,361.05	1,631.98	1,276.49	1,006.68	1,156.50
74	635.58	587.53	1,135.18	1,087.50	1,496.30	1,726.68	2,430.19	1,413.67	1,613.06	2,275.00	1,336.59	1,388.72	1,674.89	1,301.93	1,010.48	1,178.52
76	647.68	602.08	1,143.79	1,123.24	1,514.93	1,767.26	2,451.63	1,420.29	1,658.42	2,323.30	1,369.04	1,437.53	1,725.18	1,333.55	1,050.18	1,184.88
78	660.05	612.89	1,173.70	1,145.46	1,518.08	1,807.40	2,522.07	1,440.14	1,673.80	2,436.74	1,371.52	1,487.56	1,764.97	1,335.97	1,060.94	1,194.64
80	660.76	627.86	1,189.96	1,176.40	1,572.97	1,847.30	2,581.52	1,476.33	1,702.85	2,468.07	1,452.79	1,508.34	1,804.15	1,415.12	1,093.85	1,219.66
82	676.45	648.01	1,213.63	1,191.55	1,584.76	1,888.27	2,589.53	1,491.85	1,732.37	2,509.67	1,474.21	1,530.94	1,844.02	1,435.98	1,115.59	1,244.03
84	689.58	659.46	1,232.91	1,205.17	1,614.89	1,926.33	2,656.70	1,507.59	1,761.43	2,582.73	1,509.24	1,547.63	1,846.73	1,470.11	1,136.72	1,267.65
86	702.17	676.51	1,247.64	1,225.91	1,629.40	1,974.91	2,659.05	1,522.95	1,792.18	2,634.11	1,534.75	1,578.33	1,897.98	1,494.95	1,158.37	1,292.06
88	711.09	684.35	1,278.28	1,249.26	1,651.73	1,990.21	2,704.52	1,531.29	1,821.39	2,655.23	1,554.44	1,579.02	1,924.90	1,514.14	1,179.36	1,316.09
90	723.49	694.21	1,303.28	1,250.44	1,653.97	2,009.07	2,769.72	1,546.76	1,850.76	2,725.82	1,573.23	1,621.69	1,983.49	1,532.43	1,180.84	1,335.71
92	736.41	708.08	1,321.65	1,258.29	1,654.67	2,020.56	2,803.51	1,592.24	1,852.48	2,737.69	1,622.39	1,635.19	2,008.87	1,580.32	1,192.29	1,354.51
94	748.07	710.50	1,329.48	1,273.14	1,655.44	2,032.72	2,806.39	1,608.00	1,894.15	2,743.24	1,643.23	1,662.95	2,021.29	1,600.63	1,212.49	1,374.94
96	760.73	735.58	1,345.73	1,295.05	1,661.01	2,045.23	2,863.11	1,623.90	1,932.24	2,864.51	1,647.42	1,675.80	2,048.72	1,604.70	1,222.58	1,399.61
98	772.82	740.34	1,371.12	1,300.92	1,663.52	2,048.05	2,939.41	1,625.77	1,956.80	2,871.60	1,687.73	1,677.57	2,070.86	1,643.95	1,250.09	1,422.08
100	784.51	774.35	1,409.06	1,409.00	1,742.06	2,068.35	2,995.90	1,664.20	1,996.55	2,876.92	1,734.42	1,770.41	2,114.71	1,680.19	1,274.06	1,445.22
105	819.15	822.44	1,479.54	1,479.44	1,829.86	2,171.49	3,145.69	1,736.81	2,100.95	3,019.85	1,823.67	1,859.47	2,201.29	1,766.66	1,364.61	1,504.93
110	854.24	861.59	1,549.98	1,549.91	1,915.03	2,271.63	3,295.49	1,819.38	2,197.97	3,160.63	1,891.58	1,943.15	2,302.81	1,832.42	1,461.09	1,563.67
115	890.36	900.76	1,620.43	1,620.34	2,001.42	2,374.28	3,445.29	1,900.75	2,273.42	3,301.59	1,992.43	2,029.59	2,395.04	1,930.15	1,524.45	1,630.04
120	925.08	936.96	1,690.89	1,690.79	2,083.85	2,458.15	3,595.07	1,982.48	2,349.51	3,441.94	2,058.74	2,128.46	2,486.45	1,994.36	1,590.26	1,700.10
125	964.83	969.41	1,761.34	1,761.23	2,167.50	2,559.99	3,744.86	2,062.21	2,426.22	3,584.38	2,142.77	2,231.66	2,590.69	2,075.77	1,650.71	1,765.08
130	999.51	1,004.16	1,831.79	1,831.69	2,264.93	2,649.05	3,894.66	2,144.28	2,501.82	3,726.25	2,222.29	2,313.46	2,671.53	2,152.78	1,712.85	1,827.93
135	1,035.12	1,040.78	1,902.24	1,902.13	2,346.12	2,746.53	4,044.47	2,225.51	2,576.50	3,868.73	2,297.31	2,398.38	2,751.50	2,225.47	1,773.64	1,892.75
140	1,068.94	1,078.86	1,972.69	1,972.59	2,425.80	2,845.14	4,194.25	2,307.40	2,672.64	4,009.95	2,377.58	2,475.13	2,831.27	2,303.24	1,838.96	1,958.77
145	1,104.15	1,117.09	2,043.14	2,043.04	2,508.36	2,944.63	4,344.05	2,390.09	2,747.91	4,151.22	2,460.77	2,552.05	2,922.22	2,383.83	1,900.81	2,022.30
150	1,138.65	1,148.70	2,113.57	2,113.49	2,589.28	3,042.07	4,493.83	2,473.15	2,823.46	4,289.00	2,542.41	2,639.06	3,018.45	2,462.91	1,957.63	2,088.99

Shipments of More Than 150 Pounds

Zones	491	494	451	452	453	454	455	456	457	458	459	461	462	463	470	471
Price Per Pound	\$7.60	\$7.66	\$14.10	\$14.09	\$17.27	\$20.29	\$29.96	\$16.49	\$18.83	\$28.60	\$16.95	\$17.60	\$20.13	\$16.42	\$13.06	\$13.93
Minimum Rate	1,138.65	1,148.70	2,113.57	2,113.49	2,589.28	3,042.07	4,493.83	2,473.15	2,823.46	4,289.00	2,542.41	2,639.06	3,018.45	2,462.91	1,957.63	2,088.99

Note: For additional information, refer to page 28.

Import

UPS Worldwide Expedited®

Delivery by end of business day from more than 80 countries and territories. Delivery in two business days from Canada, two to three business days from Mexico and four to five business days from Asia, Europe and Latin America. Rates include door-to-door delivery with routine, in-house customs clearance by UPS Supply Chain Solutions.

Zones	61	64	651/681	652/682	653/683	654/684	655/685	656/686	657/687	658/688	659/689	661/691	662/692	663/693	670	671
1 Lbs.	\$90.77	\$67.74	\$161.49	\$108.41	\$184.89	\$133.23	\$156.61	\$127.09	\$155.86	\$191.91	\$143.58	\$127.20	\$129.96	\$144.08	\$97.79	\$102.56
2	102.47	76.21	183.58	123.92	211.06	157.55	199.36	152.89	191.29	229.94	170.02	153.72	149.67	165.50	116.39	125.05
3	117.85	84.93	201.70	144.96	232.95	181.91	235.42	178.04	225.80	267.41	192.56	173.40	170.05	187.43	131.20	138.58
4	125.04	92.77	226.22	154.04	259.45	210.23	267.10	207.41	261.14	322.40	208.45	186.02	190.05	202.90	144.56	158.21
5	134.88	100.47	244.33	176.66	284.90	229.69	297.97	228.70	287.46	371.67	231.89	201.47	208.86	225.71	159.50	173.67
6	145.44	108.84	261.56	192.64	307.63	261.80	328.13	258.22	311.29	409.36	239.72	230.53	234.02	233.35	173.79	187.39
7	163.04	112.67	276.18	196.59	325.39	280.81	369.24	284.07	335.05	441.62	270.33	254.23	255.34	263.13	189.50	204.86
8	165.36	119.84	290.56	210.14	346.29	302.13	378.41	300.46	360.61	495.43	291.35	266.16	277.19	283.59	203.38	219.74
9	173.86	123.55	304.43	221.08	387.39	322.43	400.96	338.37	384.55	570.34	306.93	286.41	299.03	298.76	213.57	235.81
10	183.28	135.59	317.67	247.03	392.44	342.78	433.35	351.88	410.31	617.82	326.53	301.09	319.96	317.84	229.21	249.67
11	197.47	136.35	332.83	259.04	415.22	361.55	470.12	372.49	431.36	634.27	346.25	308.81	341.44	337.04	239.13	261.44
12	198.43	144.21	343.67	259.09	417.99	375.61	506.52	372.54	454.01	637.93	358.92	325.43	343.34	355.89	251.97	266.29
13	201.26	149.74	359.42	275.04	457.63	404.92	513.38	396.09	479.27	710.57	382.00	340.13	380.89	371.84	264.45	285.40
14	217.73	157.11	372.75	292.72	499.74	423.62	542.13	420.92	502.44	716.41	397.59	353.53	401.29	387.02	276.00	302.35
15	219.38	158.68	383.92	300.33	522.66	436.74	561.22	457.47	524.67	773.39	413.80	363.74	422.12	402.79	291.18	317.65
16	228.28	165.42	398.10	313.01	523.95	452.31	614.09	459.95	576.46	835.17	429.83	383.28	445.08	418.40	303.35	333.95
17	228.33	170.22	409.37	321.94	544.41	492.71	624.05	476.26	599.73	855.26	442.45	394.59	462.54	430.68	310.86	346.71
18	239.76	180.18	422.16	340.56	557.11	499.40	645.25	489.31	599.78	882.76	455.01	407.29	483.29	442.90	327.35	357.08
19	240.67	184.80	434.12	349.70	587.17	522.91	655.66	517.12	610.98	892.50	464.91	430.41	504.17	452.55	338.82	378.35
20	246.49	190.65	444.63	359.59	609.90	537.21	682.11	527.69	633.17	918.11	477.38	435.94	524.47	464.68	346.21	393.11
21	252.26	195.64	456.97	388.67	627.08	555.98	735.17	540.36	663.87	918.16	488.01	440.75	552.49	475.02	355.65	406.19
22	252.31	201.03	468.82	405.16	673.81	574.71	768.99	553.16	685.82	918.21	500.39	464.19	572.55	487.08	373.46	418.36
23	266.55	204.30	478.84	416.00	673.86	598.01	797.23	563.55	697.12	967.35	529.57	487.34	595.39	515.49	383.01	428.43
24	270.43	211.85	492.25	431.66	686.53	612.04	808.63	564.64	724.21	995.43	540.23	487.93	608.81	525.85	395.60	439.37
25	272.09	218.80	511.80	431.71	695.99	629.14	813.19	568.76	741.63	1,007.44	544.93	495.13	628.19	537.89	407.66	442.73
26	276.99	226.93	513.78	457.68	728.02	656.25	829.87	587.59	769.27	1,076.99	557.57	513.15	646.39	544.83	418.94	464.13
27	281.89	234.39	544.10	471.10	784.96	665.48	849.57	592.96	789.53	1,086.80	570.21	531.00	664.36	563.17	428.89	472.10
28	290.66	239.38	547.14	483.20	785.01	683.61	870.75	651.77	809.10	1,086.85	575.05	547.25	678.91	578.81	439.77	483.61
29	291.56	242.22	547.72	491.69	792.25	702.25	870.80	662.03	827.13	1,115.79	587.48	548.29	696.77	594.04	450.38	495.15
30	296.43	248.88	559.31	497.79	822.61	719.92	870.85	679.20	874.09	1,115.84	605.69	550.06	717.32	607.90	459.82	506.02
31	296.92	255.07	579.52	514.13	838.55	738.03	931.39	701.60	901.64	1,151.43	614.00	563.84	735.64	620.77	469.11	516.24
32	297.53	260.53	581.58	530.96	844.01	764.92	957.72	703.86	901.69	1,154.99	640.40	580.73	749.03	629.90	479.34	527.12
33	309.77	263.16	589.01	537.43	898.44	772.65	973.42	721.79	910.55	1,182.06	648.19	595.51	765.20	639.75	491.92	535.66
34	318.46	267.28	598.51	552.78	900.44	792.48	987.83	731.22	910.60	1,270.40	649.31	599.62	788.23	648.23	501.84	546.67
35	319.35	272.34	609.36	565.96	900.49	822.89	1,014.25	731.27	949.37	1,296.26	664.88	618.07	810.09	658.26	509.99	555.46

Note: For additional information, refer to page 28.

Import

UPS Worldwide Expedited[®]

Zones	61	64	651/681	652/682	653/683	654/684	655/685	656/686	657/687	658/688	659/689	661/691	662/692	663/693	670	671
36 Lbs.	\$319.83	\$280.00	\$619.69	\$577.81	\$900.54	\$843.52	\$1,019.72	\$731.32	\$963.46	\$1,301.23	\$670.26	\$635.88	\$812.39	\$667.67	\$524.41	\$567.91
37	329.02	286.22	629.50	587.77	909.20	867.06	1,036.61	780.01	967.64	1,319.66	688.55	646.07	834.18	680.49	534.61	578.90
38	332.13	291.21	639.06	601.55	915.93	877.21	1,052.74	801.26	979.18	1,334.35	700.41	672.03	842.68	690.77	543.26	588.48
39	340.23	298.20	648.63	612.92	979.32	883.17	1,068.91	803.17	979.23	1,344.42	715.08	684.65	862.70	700.68	552.59	598.58
40	340.28	300.49	664.97	623.80	998.71	923.56	1,084.79	818.65	979.28	1,354.37	717.20	685.25	870.89	712.52	562.28	608.94
41	343.80	305.50	666.63	634.25	998.76	937.43	1,110.26	838.49	1,021.88	1,377.07	729.90	708.33	887.42	722.10	573.68	618.88
42	355.28	310.92	673.77	641.84	1,030.46	941.05	1,132.65	854.09	1,028.35	1,401.09	749.68	720.75	901.29	729.73	584.54	629.27
43	355.42	316.72	715.94	652.70	1,042.45	955.72	1,144.91	858.45	1,043.07	1,401.14	775.99	721.35	917.02	755.36	593.85	639.62
44	356.06	320.88	718.63	661.56	1,042.50	971.44	1,152.06	859.79	1,053.90	1,451.80	789.54	721.95	935.15	768.52	602.91	640.15
45	356.11	324.42	720.52	667.56	1,042.55	973.30	1,166.17	886.60	1,060.46	1,488.33	791.12	726.60	955.67	770.07	612.46	659.17
46	356.16	330.24	720.57	667.61	1,042.60	1,010.18	1,190.71	912.37	1,060.51	1,500.28	819.86	735.07	967.91	798.04	617.51	667.99
47	356.73	336.78	721.25	667.66	1,048.46	1,032.12	1,207.51	914.97	1,060.56	1,523.06	825.68	750.91	980.29	803.72	627.44	677.42
48	365.65	342.40	729.81	682.54	1,049.94	1,034.33	1,225.93	928.51	1,060.61	1,543.43	826.41	766.73	999.05	804.43	644.70	688.31
49	366.56	348.94	740.81	687.13	1,056.79	1,044.49	1,239.44	942.42	1,081.84	1,558.54	839.67	767.40	1,010.16	817.34	653.18	696.71
50	378.59	354.61	741.81	689.35	1,056.84	1,082.69	1,250.72	975.33	1,081.89	1,596.51	852.10	775.46	1,021.07	829.44	653.74	707.34
52	381.07	368.18	803.66	718.38	1,119.92	1,116.87	1,265.36	991.71	1,153.96	1,601.45	879.00	800.37	1,074.16	855.62	681.27	722.49
54	409.65	379.28	808.84	777.76	1,119.97	1,133.50	1,277.87	993.03	1,177.34	1,619.10	915.59	836.69	1,114.29	891.23	701.82	742.43
56	418.93	393.36	822.09	795.24	1,155.24	1,180.75	1,288.60	1,024.39	1,183.83	1,659.97	938.07	857.82	1,148.82	913.12	720.82	762.22
58	428.21	406.10	835.36	814.34	1,191.48	1,228.00	1,326.72	1,055.45	1,196.33	1,701.06	960.58	883.06	1,179.26	935.03	739.01	782.18
60	441.47	420.56	835.41	841.76	1,197.74	1,270.33	1,339.60	1,098.17	1,213.99	1,880.55	994.62	897.93	1,219.72	968.16	758.03	801.60
62	452.16	432.88	851.06	848.72	1,240.94	1,306.34	1,367.74	1,125.47	1,244.22	1,884.88	1,006.32	942.88	1,250.50	979.55	772.26	820.72
64	458.34	446.22	863.38	876.94	1,269.91	1,347.95	1,381.99	1,163.71	1,244.27	1,977.73	1,053.27	963.28	1,270.69	1,025.24	792.98	834.42
66	472.40	458.35	887.83	895.99	1,269.96	1,383.80	1,395.09	1,189.94	1,244.78	2,005.22	1,095.50	997.65	1,295.27	1,066.35	809.12	848.07
68	490.62	472.53	943.85	896.04	1,276.18	1,384.52	1,395.14	1,201.36	1,331.83	2,005.79	1,102.26	1,010.13	1,334.28	1,072.92	828.38	866.59
70	501.24	485.65	962.70	900.68	1,345.62	1,385.77	1,395.19	1,250.68	1,331.88	2,005.84	1,146.12	1,041.93	1,369.93	1,115.63	847.78	901.55
72	501.84	497.18	973.76	901.22	1,367.31	1,479.73	1,395.24	1,279.88	1,331.93	2,038.84	1,161.87	1,062.20	1,375.48	1,130.96	848.34	927.44
74	502.83	523.06	1,003.63	940.29	1,393.70	1,495.84	1,410.03	1,285.63	1,331.98	2,084.27	1,176.15	1,077.73	1,407.33	1,144.86	885.76	953.03
76	524.67	523.11	1,003.68	940.88	1,396.77	1,511.42	1,410.08	1,286.30	1,332.03	2,087.29	1,235.81	1,107.00	1,444.54	1,202.95	886.33	962.39
78	536.73	534.66	1,003.73	964.26	1,396.82	1,551.30	1,419.74	1,286.94	1,336.91	2,155.19	1,264.29	1,127.33	1,476.44	1,230.65	905.85	970.30
80	538.23	547.39	1,006.24	971.19	1,396.87	1,589.25	1,432.31	1,290.73	1,423.13	2,220.33	1,291.37	1,176.62	1,510.10	1,257.02	915.72	990.63

Note: For additional information, refer to page 28.

Import

UPS Worldwide Expedited®

Zones	61	64	651/681	652/682	653/683	654/684	655/685	656/686	657/687	658/688	659/689	661/691	662/692	663/693	670	671
82 Lbs.	\$546.90	\$589.80	\$1,064.93	\$988.13	\$1,403.32	\$1,628.87	\$1,513.01	\$1,303.35	\$1,437.34	\$2,223.44	\$1,308.21	\$1,204.09	\$1,547.15	\$1,273.42	\$933.92	\$1,010.44
84	559.15	591.09	1,076.61	996.25	1,420.47	1,667.70	1,528.39	1,328.94	1,450.96	2,247.74	1,321.72	1,223.16	1,554.64	1,286.55	952.64	1,029.59
86	564.47	598.35	1,076.66	1,042.02	1,420.52	1,706.81	1,542.95	1,356.06	1,451.01	2,282.24	1,353.12	1,251.66	1,590.81	1,317.13	997.94	1,049.41
88	573.48	600.10	1,076.71	1,060.82	1,441.80	1,732.46	1,557.75	1,361.14	1,451.06	2,334.27	1,386.29	1,270.52	1,615.78	1,349.42	1,016.51	1,068.96
90	582.84	600.15	1,076.76	1,061.38	1,441.85	1,755.94	1,573.07	1,392.98	1,451.11	2,366.17	1,407.45	1,278.38	1,651.13	1,370.00	1,017.07	1,084.87
92	585.91	600.20	1,078.62	1,063.99	1,441.90	1,756.62	1,573.12	1,393.80	1,451.16	2,417.61	1,408.15	1,293.94	1,678.62	1,370.70	1,025.10	1,100.10
94	593.14	619.44	1,089.13	1,072.02	1,441.95	1,757.31	1,573.17	1,418.43	1,451.21	2,466.64	1,424.83	1,321.47	1,703.07	1,386.92	1,027.56	1,116.26
96	593.19	631.14	1,101.80	1,140.57	1,445.53	1,757.92	1,573.22	1,450.11	1,461.04	2,494.46	1,436.01	1,348.93	1,735.57	1,397.82	1,044.51	1,128.98
98	595.85	664.10	1,101.97	1,142.95	1,446.64	1,758.53	1,573.27	1,452.37	1,471.37	2,543.35	1,452.33	1,380.88	1,769.26	1,413.70	1,045.07	1,143.83
100	596.43	671.68	1,120.19	1,196.30	1,458.49	1,781.34	1,586.63	1,481.04	1,486.05	2,822.03	1,520.22	1,396.17	1,799.62	1,426.06	1,074.43	1,165.52
105	626.26	706.62	1,176.23	1,260.91	1,521.08	1,842.16	1,659.68	1,555.09	1,529.46	2,963.13	1,629.95	1,458.22	1,911.33	1,478.22	1,142.17	1,204.20
110	656.07	740.00	1,231.23	1,318.57	1,600.46	1,924.45	1,694.58	1,629.16	1,559.64	3,103.85	1,754.05	1,516.59	2,003.84	1,543.60	1,179.79	1,243.87
115	685.89	772.94	1,274.00	1,376.16	1,666.67	2,011.93	1,741.82	1,703.21	1,603.35	3,244.28	1,883.76	1,582.25	2,103.01	1,613.76	1,221.85	1,288.73
120	715.72	804.61	1,310.22	1,435.05	1,732.79	2,099.41	1,791.31	1,777.26	1,634.00	3,382.17	1,883.81	1,623.01	2,197.10	1,683.91	1,285.63	1,336.20
125	745.52	838.16	1,378.19	1,494.39	1,801.53	2,186.87	1,839.45	1,851.30	1,663.19	3,523.06	1,983.65	1,657.62	2,298.53	1,751.91	1,336.86	1,381.48
130	775.34	874.95	1,437.20	1,553.26	1,879.14	2,274.35	1,887.63	1,925.35	1,708.74	3,660.49	2,051.77	1,691.55	2,356.59	1,790.94	1,389.52	1,424.73
135	805.17	906.09	1,486.47	1,612.97	1,929.89	2,361.82	1,920.15	1,999.40	1,737.86	3,801.30	2,117.70	1,726.41	2,440.10	1,827.87	1,441.52	1,474.65
140	834.50	941.29	1,518.20	1,673.89	1,962.66	2,426.55	1,957.06	2,073.45	1,783.68	3,938.19	2,149.04	1,729.82	2,531.38	1,831.46	1,480.19	1,514.93
145	864.23	973.88	1,558.55	1,734.86	2,020.41	2,480.44	1,990.08	2,147.51	1,841.51	4,078.91	2,214.36	1,764.18	2,594.40	1,867.79	1,513.97	1,548.54
150	893.88	1,005.09	1,601.04	1,794.73	2,052.58	2,536.80	2,024.77	2,221.55	1,873.41	4,211.54	2,304.58	1,798.05	2,703.35	1,902.07	1,547.78	1,582.79

Determining the Rate

Shipments of More Than 150 Pounds

Zones	61	64	651/681	652/682	653/683	654/684	655/685	656/686	657/687	658/688	659/689	661/691	662/692	663/693	670	671
Price Per Pound	\$5.96	\$6.71	\$10.68	\$11.97	\$13.69	\$16.92	\$13.50	\$14.82	\$12.49	\$28.08	\$15.37	\$11.99	\$18.03	\$12.69	\$10.32	\$10.56
Minimum Rate	893.88	1,005.09	1,601.04	1,794.73	2,052.58	2,536.80	2,024.77	2,221.55	1,873.41	4,211.54	2,304.58	1,798.05	2,703.35	1,902.07	1,547.78	1,582.79

Note: For additional information, refer to page 28.

Import

UPS 3 Day Select® from Canada

Delivery by the end of the third business day to the 48 contiguous states from all Canadian provinces.

Rates include door-to-door delivery with routine, in-house customs clearance by UPS Supply Chain Solutions.

Zones	475	476	477
1 Lbs.	\$55.19	\$55.48	\$57.06
2	59.33	60.52	62.94
3	63.31	65.68	68.56
4	66.62	70.63	74.47
5	70.49	75.94	79.67
6	74.58	81.10	85.57
7	77.85	86.25	91.39
8	81.92	91.06	97.13
9	85.71	96.10	102.83
10	89.62	100.87	107.99
11	93.23	104.83	112.81
12	96.63	108.73	117.47
13	100.50	112.39	121.82
14	103.98	116.22	126.25
15	107.79	119.64	130.12
16	111.41	122.99	134.21
17	114.72	126.60	137.99
18	118.22	130.15	142.09
19	121.54	133.15	145.84
20	124.94	136.25	149.56
21	128.24	138.73	152.51
22	131.23	141.21	154.86
23	136.80	143.46	157.46
24	139.64	146.01	159.52
25	142.77	148.23	161.87
26	145.71	150.70	163.96
27	150.09	153.11	166.22
28	153.04	155.31	168.49
29	155.78	157.61	170.66
30	158.63	160.21	173.10
31	161.21	162.15	178.89
32	163.70	164.42	181.40
33	166.48	166.68	183.76
34	168.54	169.04	186.12
35	169.88	171.23	191.52

Zones	475	476	477
36 Lbs.	\$172.47	\$173.59	\$194.08
37	174.33	176.07	195.48
38	175.73	178.27	198.65
39	177.59	180.67	200.95
40	180.13	183.46	203.51
41	181.29	186.13	205.87
42	183.99	188.43	208.31
43	185.57	190.63	210.58
44	187.51	193.33	212.13
45	189.50	195.13	215.24
46	190.63	197.56	217.30
47	192.64	199.85	219.68
48	195.38	201.91	222.33
49	196.61	204.21	224.54
50	199.15	206.07	227.04
52	203.24	211.12	231.45
54	204.33	215.69	236.14
56	210.23	220.31	241.24
58	214.23	224.90	245.82
60	219.18	228.66	250.83
62	222.53	234.36	255.53
64	226.51	238.80	260.35
66	230.46	243.62	265.05
68	235.17	248.19	269.70
70	239.27	252.63	274.61
72	243.37	257.26	279.55
74	247.33	261.83	283.91
76	251.34	266.20	288.97
78	255.18	270.81	293.49
80	259.36	275.53	301.02
82	263.06	279.96	303.14
84	267.12	284.43	307.80
86	270.25	289.23	312.27
88	274.91	293.60	316.80
90	279.06	298.08	321.42

Zones	475	476	477
92 Lbs.	\$282.99	\$302.72	\$326.01
94	286.80	307.36	330.68
96	290.58	311.67	335.22
98	294.50	316.72	339.53
100	298.54	321.36	344.04
105	308.86	332.54	362.57
110	319.09	344.15	380.47
115	329.37	355.91	398.33
120	339.51	367.42	415.93
125	348.39	378.96	433.71
130	358.43	390.38	451.32
135	369.87	401.92	469.28
140	380.02	413.42	486.78
145	390.17	424.98	504.61
150	400.74	436.73	522.45

Shipments of More Than 150 Pounds

Zones	475	476	477
Price Per Pound	\$2.68	\$2.92	\$3.49
Minimum Rate	400.74	436.73	522.45

Note: For additional information, refer to page 28.

Import

UPS® Standard from Canada*

Delivery by end of day to the 48 contiguous states within two to seven business days from all Canadian provinces. Rates include door-to-door delivery. Customs clearance is not included. See pages 140-141 for U.S. Entry Preparation rates. UPS will provide Customs Brokerage Services by UPS Supply Chain Solutions unless a different broker is specified. Charges will be billed to the importer unless otherwise indicated by the shipper. Saturday Delivery available in select areas.

Zones	376	378	380
1 Lbs.	\$28.93	\$29.44	\$30.39
2	30.39	30.78	32.31
3	31.53	32.17	34.18
4	32.31	33.78	36.40
5	33.58	35.32	37.98
6	34.53	35.97	39.86
7	35.46	37.05	41.73
8	36.57	38.66	43.67
9	37.33	40.20	45.54
10	38.52	41.68	47.54
11	38.65	42.52	48.75
12	39.38	44.12	50.68
13	40.00	45.76	52.41
14	40.38	47.09	54.30
15	40.85	48.55	56.16
16	41.85	49.75	57.76
17	42.96	51.01	59.77
18	44.12	52.36	61.37
19	44.91	53.63	63.30
20	45.59	54.63	65.25
21	47.98	57.54	68.54
22	48.53	58.29	70.26
23	49.68	59.87	72.09
24	50.45	60.89	73.81
25	51.32	62.07	75.72
26	52.29	63.23	77.62
27	53.18	64.66	79.34
28	55.38	66.86	82.50
29	55.49	67.21	83.08
30	56.81	68.95	85.36

Zones	376	378	380
31 Lbs.	\$57.63	\$69.46	\$87.24
32	59.01	70.84	89.13
33	59.76	72.06	90.97
34	61.68	74.07	93.78
35	62.13	74.27	94.60
36	63.17	75.78	96.66
37	64.28	77.63	98.24
38	65.45	79.42	100.24
39	66.98	82.11	103.18
40	67.57	82.98	103.92
41	68.71	84.63	105.79
42	70.91	87.78	109.71
43	71.59	89.02	110.67
44	72.06	89.85	111.41
45	73.60	92.55	113.84
46	74.12	93.14	114.97
47	75.02	94.79	116.56
48	76.99	97.58	119.74
49	77.28	98.08	120.07
50	78.51	99.65	121.31
52	80.85	103.14	125.28
54	83.25	106.86	129.22
56	85.77	110.13	133.22
58	88.16	113.51	136.96
60	90.63	116.88	140.59
62	93.04	120.02	144.35
64	95.64	123.25	147.97
66	98.09	126.26	152.01
68	102.13	131.89	158.77
70	104.67	134.76	162.12

*Visit [ups.com/holidays](https://www.ups.com/holidays) for time in transit changes effective during the holiday season.

Notes:

- For additional information, refer to pages 28 and 96.
- For a multiple-package shipment, the minimum charge will be based on an average weight of 15 pounds per package.

Import

UPS® Standard from Canada*

Zones	376	378	380
72 Lbs.	\$106.98	\$137.99	\$166.21
74	108.84	140.06	169.25
76	111.25	143.08	173.46
78	113.61	146.56	177.85
80	114.52	147.81	179.50
82	115.97	150.01	182.52
84	119.99	155.36	189.10
86	120.34	155.71	190.06
88	124.10	159.40	195.12
90	124.65	161.25	197.59
92	126.65	163.73	201.53
94	128.99	166.00	205.28
96	131.64	168.52	208.93
98	135.14	173.72	216.12
100	135.27	173.81	216.29
105	138.27	176.39	222.07
110	142.24	179.56	227.50
115	145.90	182.69	232.89
120	149.51	185.66	238.47
125	152.88	188.66	244.07
130	156.25	191.75	249.52
135	159.73	195.28	255.00
140	162.89	198.26	260.67
145	166.38	201.32	265.95
150	169.48	204.29	271.54

Shipments of More Than 150 Pounds

Zones	376	378	380
Price Per Pound	\$1.13	\$1.36	\$1.81
Minimum Rate	169.48	204.29	271.54

*Visit [ups.com/holidays](https://www.ups.com/holidays) for time in transit changes effective during the holiday season.

Note: For additional information, refer to pages [28](#) and [96](#).

Import

UPS® Standard from Mexico*

Delivery by end of day to the 48 contiguous states within three to seven business days from Mexico. Service not available from Baja California and Baja California Sur. Rates include routine, in-house customs clearance by UPS Supply Chain Solutions. Saturday Delivery available in select areas.

Zones	362	363	364	365	366	367	368
1 Lbs.	\$50.55	\$50.95	\$51.35	\$52.24	\$52.80	\$53.18	\$53.76
2	57.45	58.10	58.36	59.83	60.46	60.90	61.23
3	64.25	64.75	64.98	66.33	66.58	67.23	67.95
4	70.29	70.74	71.06	72.65	73.29	74.58	75.52
5	77.45	77.91	78.20	79.33	82.30	82.81	83.23
6	83.77	84.16	84.63	86.03	89.08	89.72	90.08
7	88.16	88.80	89.10	89.23	93.64	94.29	95.18
8	90.90	91.42	91.91	93.42	96.45	100.56	101.78
9	94.29	94.90	95.36	97.02	99.96	103.89	106.80
10	96.33	96.72	97.25	98.78	101.81	105.71	108.64
11	99.14	99.60	100.02	101.58	104.57	108.54	111.45
12	101.50	101.89	102.30	103.80	106.84	110.89	113.73
13	103.72	104.10	104.69	106.10	109.14	113.11	115.96
14	106.33	106.97	107.59	108.76	112.02	115.68	118.90
15	109.46	110.19	110.67	111.97	115.86	119.79	123.40
16	111.42	112.27	112.69	114.24	118.62	123.00	126.66
17	114.12	115.28	115.55	117.39	122.00	126.38	130.59
18	115.99	117.37	117.72	119.92	124.71	129.46	133.86
19	118.33	120.18	120.66	122.89	128.10	132.94	137.65
20	119.80	121.87	122.36	125.03	130.24	135.36	140.32
21	120.39	122.47	123.00	125.63	130.92	135.97	141.10
22	122.26	124.64	125.22	128.11	133.68	138.96	144.50
23	124.95	127.31	127.98	131.04	136.80	142.22	147.92
24	127.91	130.51	131.12	134.51	140.52	146.09	152.08
25	130.58	133.13	133.78	137.32	143.67	149.29	155.82
26	132.59	135.23	136.44	139.98	146.46	152.15	159.27
27	135.15	137.69	138.95	142.80	149.73	155.55	162.94
28	137.56	140.45	141.82	145.75	152.81	158.88	166.60
29	140.58	143.38	144.90	148.88	156.35	162.47	170.65
30	142.55	145.43	146.27	150.32	158.11	164.31	172.85
31	143.45	146.39	148.49	152.67	160.85	167.17	176.14
32	145.35	147.90	150.05	154.23	162.73	169.14	178.16
33	146.51	149.80	151.88	156.52	164.89	171.49	180.84
34	149.06	152.60	154.83	159.54	168.02	174.90	184.69
35	152.08	155.79	158.11	162.99	171.82	178.69	188.69

*Visit [ups.com/holidays](https://www.ups.com/holidays) for time in transit changes effective during the holiday season.

Notes:

- For additional information, refer to pages [28](#) and [96](#).
- For a multiple-package shipment, the minimum charge will be based on an average weight of 15 pounds per package.

Import

UPS® Standard from Mexico*

Zones	362	363	364	365	366	367	368
36 Lbs.	\$152.58	\$156.29	\$158.61	\$163.49	\$172.32	\$179.19	\$189.19
37	156.46	160.18	162.55	167.32	175.74	182.31	191.26
38	159.40	163.22	165.63	170.12	178.94	185.32	194.28
39	162.22	165.96	168.21	172.98	181.57	188.07	197.02
40	164.52	168.01	170.42	175.14	183.79	190.11	199.32
41	167.44	171.09	173.42	178.02	186.73	193.37	202.25
42	170.69	174.54	176.80	181.52	190.05	196.64	205.62
43	173.12	176.96	179.35	183.96	192.80	199.13	208.51
44	175.36	177.98	180.38	185.08	193.96	200.32	209.45
45	175.94	179.39	181.78	186.55	195.22	201.72	210.85
46	177.66	181.30	183.74	188.34	197.16	203.79	212.85
47	178.25	181.89	184.33	188.93	198.03	204.43	213.60
48	180.59	184.29	186.68	191.21	199.82	206.28	215.33
49	184.19	187.70	190.00	194.78	203.27	209.79	218.70
50	186.88	190.37	192.81	197.53	206.08	212.62	221.58
52	191.60	195.29	198.09	203.64	212.22	218.66	227.59
54	199.65	203.40	206.14	211.60	220.19	226.64	235.68
56	208.52	212.16	214.99	220.41	229.15	235.46	244.41
58	214.19	217.83	220.60	226.13	234.77	241.07	250.08
60	220.00	223.51	226.34	231.81	240.51	246.83	255.72
62	225.56	229.26	231.95	237.44	246.21	252.53	261.45
64	230.04	233.69	236.98	243.16	252.84	262.04	269.96
66	235.61	239.30	242.60	248.90	258.60	267.72	275.57
68	241.34	244.92	248.21	254.63	264.27	273.27	281.25
70	247.14	250.73	253.88	260.25	270.02	279.01	287.03
72	252.77	256.35	259.54	265.86	275.57	284.71	292.72
74	258.60	262.17	265.36	271.61	281.40	290.46	298.39
76	262.34	266.00	269.25	277.27	287.09	298.04	305.03
78	268.11	271.93	275.03	283.40	293.07	304.12	311.30
80	269.38	273.07	276.17	284.46	294.29	305.21	312.26
82	273.72	277.42	280.52	288.68	298.51	309.50	316.41
84	279.40	282.98	286.12	294.42	304.00	315.04	322.01
86	285.22	288.92	291.86	300.01	309.88	320.73	327.76
88	290.89	294.47	297.69	305.82	315.37	326.53	333.50
90	296.64	300.48	303.41	311.57	321.23	332.61	339.04

*Visit ups.com/holidays for time in transit changes effective during the holiday season.

Note: For additional information, refer to pages [28](#) and [96](#).

Import

UPS® Standard from Mexico*

Zones	362	363	364	365	366	367	368
92 Lbs.	\$302.99	\$306.55	\$309.51	\$317.24	\$326.73	\$338.04	\$344.73
94	309.36	312.62	315.78	322.97	332.23	343.53	350.27
96	315.30	318.55	321.81	328.66	337.65	348.84	355.71
98	320.73	323.34	326.93	333.31	342.19	353.63	360.56
100	326.23	328.20	332.21	338.07	347.04	358.48	365.59
105	327.45	329.47	332.98	338.67	348.13	359.37	366.17
110	338.12	339.88	342.17	347.33	355.67	366.78	373.68
115	350.24	352.60	355.10	359.82	368.37	379.82	386.86
120	364.74	366.60	369.50	373.91	382.73	394.62	401.84
125	369.77	371.89	374.80	378.63	387.59	399.23	406.37
130	383.01	385.62	388.50	392.03	401.02	412.77	420.08
135	396.17	399.29	402.40	405.28	414.36	425.92	433.68
140	399.68	402.92	405.91	408.13	417.10	428.28	435.84
145	417.25	421.00	424.21	425.92	434.99	446.17	454.09
150	432.19	436.53	439.88	441.10	450.14	461.25	469.35

Shipments of More Than 150 Pounds

Zones	362	363	364	365	366	367	368
Shipments of 151 to 199 Pounds							
Price Per Pound	\$2.89	\$2.92	\$2.94	\$2.95	\$3.01	\$3.08	\$3.13
Minimum Rate	432.19	436.53	439.88	441.10	450.14	461.25	469.35
Shipments of 200 Pounds or More							
Price Per Pound	\$2.75	\$2.75	\$2.75	\$2.78	\$2.83	\$2.89	\$2.96
Minimum Rate	573.37	579.13	583.57	585.19	597.19	611.92	622.67

*Visit [ups.com/holidays](https://www.ups.com/holidays) for time in transit changes effective during the holiday season.

Note: For additional information, refer to pages [28](#) and [96](#).

Value-Added Services

Value-added services are available for the UPS services indicated. For additional information and rates, refer to pages [116-126](#) and [150](#).

	Domestic							International							Page			
	UPS Next Day Air® Early	UPS Next Day Air®	UPS Next Day Air Saver®	UPS 2nd Day Air A.M.®	UPS 2nd Day Air®	UPS 3 Day Select®	UPS® Ground	UPS Worldwide Express Plus®	UPS Worldwide Express NAI®	UPS Worldwide Express®	UPS Worldwide Express Freight® Midday	UPS Worldwide Express Freight®	UPS Worldwide Saver®	UPS Worldwide Expedited®	UPS 3 Day Select® from Canada	UPS® Standard to/from Canada	UPS® Standard to/from Mexico	
Delivery Options																		
Signature Required		●	●	●	●	●	●	●	●	●	●	●	●	●	●	●	●	116
Adult Signature Required	●	●	●	●	●	●	●	●	●	●	●	●	●	●	●	●	●	116
UPS Collect on Delivery (C.O.D.) Service	●	●	●	●	●	●	●								●	●		116
C.O.D. Services through UPS Capital®																		116
Hold for Pickup*	●	●	●	●	●	●	●											117
Hold at Location											●	●						117
Ship to a UPS Access Point® Location	●	●	●	●	●	●	●	●	●	●			●	●	●	●	●	117
Direct Delivery Only	●	●	●	●	●	●	●	●	●	●			●	●	●	●	●	117
UPS Delivery Intercept®	●	●	●	●	●	●	●											117
Pickup Options																		
Daily Pickup	●	●	●	●	●	●	●	●	●	●			●	●	●	●	●	118
Daily On-Route Pickup	●	●	●	●	●	●	●	●	●	●			●	●	●	●	●	118
UPS Smart Pickup®	●	●	●	●	●	●	●	●	●	●			●	●	●	●	●	118
Day-Specific Pickup	●	●	●	●	●	●	●	●	●	●			●	●	●	●	●	118
UPS On-Call Pickup®	●	●	●	●	●	●	●	●	●	●	●	●	●	●	●	●	●	118
Weekend Services																		
Saturday Stop Charge** – Scheduled Pickup	●	●	●	●	●	●	●											119
Saturday Stop Charge** – UPS Smart Pickup	●	●	●	●	●	●	●											119
Saturday Stop Charge** – UPS On-Call Pickup	●	●	●	●	●	●	●											119
Saturday Air Processing Fee	●	●	●	●	●	●	●											119
Saturday Export Processing Fee								●	●			●						119
Saturday Delivery***	●	●		●	●	●	●	●	●	●	●				●	●		119
Return Services†																		
Print Return Label	●	●		●	●	●	●	●	●	●	●	●	●	●	●	●	●	120
Electronic Return Label	●	●		●	●	●	●	●	●	●	●	●	●	●	●	●	●	120
1 UPS Pickup Attempt Label	●	●		●	●	●	●	●	●	●	●	●	●	●	●	●	●	120
3 UPS Pickup Attempts Label	●	●		●	●	●	●	●	●	●	●	●	●	●	●	●	●	120
Other Services – General																		
Declared Value for Carriage	●	●	●	●	●	●	●	●	●	●	●	●	●	●	●	●	●	121
UPS carbon neutral	●	●	●	●	●	●	●	●	●	●	●	●	●	●	●	●	●	121
Proof of Delivery (P.O.D.)	●	●	●	●	●	●	●	●	●	●	●	●	●	●	●	●	●	121
Branded Tracking from UPS	●	●	●	●	●	●	●	●	●	●	●	●	●	●	●	●	●	121
UPS® Premier	●	●	●															121
Third Party Billing Service	●	●	●	●	●	●	●	●	●	●	●	●	●	●	●	●	●	121
Other Services – International																		
Duty and Tax Forwarding								●	●	●	●	●	●	●	●	●	●	122
Currency Conversion Rate								●	●	●	●	●	●	●	●	●	●	122
Non-Resident Importer (NRI)								●	●	●	●	●	●	●	●	●	●	122
Certificate of Origin								●	●	●	●	●	●	●	●	●	●	122
Electronic Export Information (E.E.I.)								●	●	●	●	●	●	●	●	●	●	122
UPS Import Control®								●	●	●	●	●	●	●	●	●	●	123
World Ease®								●	●	●	●	●	●	●	●	●	●	123
Recipient Services																		
Delivery Change Request	●	●	●	●	●	●	●	●	●	●	●	●	●	●	●	●	●	124
UPS My Choice®	●	●	●	●	●	●	●	●	●	●	●	●	●	●	●	●	●	125
UPS My Choice® for Business	●	●	●	●	●	●	●	●	●	●	●	●	●	●	●	●	●	126
UPS Automatic Alerts for Non-UPS My Choice Members	●	●	●	●	●	●	●	●	●	●	●	●	●	●	●	●	●	126

*Hold for Pickup available only at select UPS Customer Centers.

**Saturday Pickup is only available for UPS 3 Day Select and UPS Ground services in select areas.

***Saturday Delivery is only available for UPS 3 Day Select, UPS Ground, UPS Standard from Canada and UPS Standard from Mexico services in select areas. Saturday Delivery is not available for UPS Standard to Canada or UPS Standard to Mexico services.

† UPS Returns® Service options for UPS® Simple Rate are limited to UPS Print Return Label Service only.

Note: For additional information on Value-Added Services, refer to the Appendix on page [150](#).

Other Charges

Additional charges may apply to your package shipment. For additional information and rates, refer to pages [127-130](#).

	Domestic							International										Page
	UPS Next Day Air® Early	UPS Next Day Air®	UPS Next Day Air Saver®	UPS 2nd Day Air A.M.®	UPS 2nd Day Air®	UPS 3 Day Select®	UPS® Ground	UPS Worldwide Express Plus®	UPS Worldwide Express MA1®	UPS Worldwide Express®	UPS Worldwide Express Freight® Midday	UPS Worldwide Express Freight®	UPS Worldwide Saver®	UPS Worldwide Expedited®	UPS 3 Day Select® from Canada	UPS® Standard to/from Canada	UPS® Standard to/from Mexico	
Additional Handling	●	●	●	●	●	●	●	●	●	●	●	●	●	●	●	●	●	127
Address Correction	●	●	●	●	●	●	●	●	●	●	●	●	●	●	●	●	●	127
Chargeback for Consignee Billing Shipments	●	●	●	●	●	●	●	●	●	●	●	●	●	●	●	●	●	127
Dangerous Goods																		
– International Dangerous Goods								●	●	●	●	●	●	●	●	●	●	128
– Hazardous Materials	●	●	●	●	●	●	●											128
– Dry Ice	●	●	●	●	●	●	●	●	●	●	●	●	●					129
Delivery Area Surcharge	●	●	●	●	●	●	●	●	●	●			●	●	●	●	●	128
Delivery Reattempt											●	●						128
Demand Surcharges	●	●	●	●	●	●	●	●	●	●	●	●	●	●	●	●	●	128
Destination Outside Service Area	●																	128
Extended Area Surcharge								●	●	●	●	●	●	●	●	●	●	129
Large Package Surcharge	●	●	●	●	●	●	●	●	●	●			●	●	●	●	●	129
Missing PLD Fee	●	●	●	●	●	●	●	●	●	●	●	●	●	●	●	●	●	129
Missing/Invalid Account Number or Refusal Fee	●	●	●	●	●	●	●	●	●	●	●	●	●	●	●	●	●	129
UPS On-Call Pickup® Area Surcharge	●	●	●	●	●	●	●	●		●			●	●		●	●	129
Over Maximum Limits	●	●	●	●	●	●	●	●	●	●			●	●	●	●	●	129
Oversize Pallet Handling Surcharge											●	●						129
Package Tracking, Tracing and Refund Requests	●	●	●	●	●	●	●	●	●	●	●	●	●	●	●	●	●	129
Paper Commercial Invoice Services Surcharge								●	●	●	●	●	●	●	●	●	●	130
Pickup Area Surcharge											●	●						130
Prohibited Item Fee	●	●	●	●	●	●	●	●	●	●	●	●	●	●	●	●	●	130
Rebill Fee	●	●	●	●	●	●	●	●	●	●	●	●	●	●	●	●	●	130
Remote Area Surcharge	●	●	●	●	●	●	●	●	●	●	●	●	●	●	●	●	●	130
Residential Surcharge	●	●	●	●	●	●	●	●	●	●	●	●	●	●	●	●	●	130
Shipping Charge Correction Audit Fee*	●	●	●	●	●	●	●	●		●	●	●	●	●		●	●	130
Special Handling of Undeliverable Shipments	●	●	●	●	●	●	●											130
Undeliverable Shipment Surcharge								●	●	●	●	●	●	●	●	●	●	130

*Shipping Charge Correction Audit Fee does not apply to import shipments.

Notes:

- Demand Surcharges also apply to certain packages tendered during Demand Periods. See ups.com/peaksurcharges for details.
- The following surcharges do not apply to UPS® Simple Rate shipments: Delivery Area Surcharge, Delivery Area Surcharge Extended, Residential Surcharge and fuel surcharges. All other charges apply to UPS Simple Rate shipments.
- For additional information on Other Charges, refer to the Appendix on page [151](#).

Domestic, Export and Import Value-Added Services – Delivery Options

PACKAGE

Available Options	Description	Fee
SIGNATURE REQUIRED SERVICES		
Signature Required	– UPS will obtain a signature upon delivery. UPS may obtain, at its discretion, an electronic authorization to release the package without a signature on delivery.	\$6.75 per package
Adult Signature Required	– UPS will obtain an adult recipient's signature upon delivery. Adult recipients must be at least 21 years old (government-issued photo ID required for delivery).	\$8.15 per package
COLLECT ON DELIVERY (C.O.D.) SERVICES		
UPS Collect on Delivery (C.O.D.)	<ul style="list-style-type: none"> – UPS will attempt to collect the amount shown on C.O.D. tag or package label, then send payment to you. – If payment cannot be collected after three attempts, the package will be returned. – C.O.D. service is available for packages shipped throughout the U.S. and Puerto Rico. – Also available for imports from Canada, where the fee would apply per package. – Business or personal checks are accepted as payment. Currency is not accepted for payment. UPS may, in its sole and unlimited discretion, decide to accept payment of C.O.D.s through electronic payment methods. – C.O.D. service is not available when using a UPS 3 Day Select® or UPS® Ground shipping document. Refer to page 24 for an explanation of these documents. – To request a C.O.D. electronically: <ul style="list-style-type: none"> • Service is available by using a UPS automated shipping system. • The shipping system will produce a barcoded address label that contains all C.O.D. information. – To request a C.O.D. using a manual tag: <ul style="list-style-type: none"> • Type or print an address label and attach it to the top of the package. • Complete the UPS C.O.D. tag per the instructions on the tag and specify the exact amount due. • Attach C.O.D. tag to each package requiring collection, covering the address label. • Retain the "Shipper Receipt" portion for your records. 	\$19.00 per package
Enhanced C.O.D. Services – UPS Capital**	– For large C.O.D. shippers, additional contractual services are available through UPS Capital. Visit upscapital.com/business-services/payment-services/cod or call 1-877-263-8772 for more information.	Contractual service
C.O.D. Direct®	– Receive C.O.D. payments, generally within six business days of package delivery, via a direct electronic transfer of funds into your designated account(s).	
C.O.D. Automatic®	– Receive advanced C.O.D. funds in as few as two business days after package delivery via a direct electronic transfer of funds into your designated account(s).	
Delayed Deposit for C.O.D. Direct and C.O.D. Automatic	– An additional feature of C.O.D. Direct and C.O.D. Automatic services. Eliminates the manual handling of checks held for delayed deposits by electronically scheduling future deposits directly into your designated accounts.	
C.O.D. Secure®	– Receive all the benefits of C.O.D. Automatic service, along with protection for returned C.O.D. checks up to a specified limit.	

*C.O.D. enhancement services are offered through UPS Capital Trade Protection Services, Inc. UPS Capital Corporation and its affiliates reserve the right to change or cancel any C.O.D. enhancement services program at any time. Each C.O.D. enhancement services program is governed by the applicable terms and conditions governing participation in that program, and certain limitations and exclusions apply. Information contained in the UPS Capital website (upscapital.com/business-services/payment-services/cod) does not in any way alter, supplement or amend the applicable terms and conditions governing participation in any C.O.D. enhancement services program and is intended only as a brief summary of that program. The UPS C.O.D. charges, as set forth in the UPS rates in effect at the time of shipping, apply to each UPS C.O.D. package shipped. Some C.O.D. enhancement services may involve loans or the advancement of funds for anticipated C.O.D. receipts. Loans made in California are pursuant to a Department of Corporations California Finance Lenders License. C.O.D. enhancement services products may not be available in all jurisdictions and may be modified based on requirements. Check with your UPS Capital representative for local availability. Credit availability is subject to approval. C.O.D. Secure, C.O.D. Automatic and C.O.D. Direct are registered trademarks of United Parcel Service of America, Inc.

Notes:

- The value-added services listed are available for UPS domestic, international package and UPS Worldwide Express Freight® services unless otherwise noted on page 114. Unless otherwise noted, UPS rates are per package for domestic services and per shipment for international services.
- Fuel surcharges apply to value-added services associated with pickup, transport and delivery. For current fuel surcharges, where applicable, visit ups.com/fuelsurcharge.

Domestic, Export and Import

Value-Added Services – Delivery Options

PACKAGE

Available Options	Description	Fee
ALTERNATIVE DELIVERY LOCATIONS		
Hold for Pickup*	<ul style="list-style-type: none"> – UPS will deliver the package to a selected UPS Customer Center and call the recipient for pickup, usually by 8:30 a.m. on the scheduled day of delivery. – Recipient will be required to present a government-issued photo ID. – If a recipient's representative is picking up the package, a letter on company letterhead authorizing release or a company ID may be required. – Packages not picked up within five business days will be returned to the shipper. – Hold for Pickup* service is not available for Saturday Delivery. – For each package, customers must prepare a label including the words "Hold for Pickup," the recipient's name and telephone number, and the full address of the UPS Customer Center. – Apply a UPS Hold for Pickup* label above the address label on the package. Labels can be ordered from ups.com. – Visit ups.com for the most convenient UPS Hold for Pickup* location. 	No charge
Hold at Location	<ul style="list-style-type: none"> – For UPS Worldwide Express Freight® Midday or UPS Worldwide Express Freight® shipments, the shipper may request that UPS hold a shipment at a UPS Worldwide Express Freight Center location for pickup. For each such shipment, the shipper will complete an address label showing the words "Hold for Pickup," the recipient's name and telephone number, the name of a contact person, and the full address of the recipient (designated UPS Worldwide Express Freight Center address not required). 	No charge
Ship to a UPS Access Point® Location	<ul style="list-style-type: none"> – For the convenience of recipients, shippers can send packages directly to a UPS Access Point Location. – Recipients will be notified by email when their packages arrive at the UPS Access Point Location. The alert includes tracking number, notification that the package has arrived at the UPS Access Point Location, and UPS Access Point Location information, including address, hours of operation, ID requirements, or other requirements for pickup. – Shippers can integrate a UPS Locator into their e-commerce platforms, allowing their customers to select the UPS Access Point delivery location that is most convenient for them. – Only shippers with an approved UPS agreement for transportation of alcohol may ship alcohol to a UPS Access Point Location that accepts regulated goods. – Additional service options for Ship to a UPS Access Point Location include: <ul style="list-style-type: none"> • Deliver to Addressee Only: For added security with Ship to a UPS Access Point Location, the shipment may only be picked up by the person identified on the shipping label (pickup by any third party is not permitted). • Package Release Code: For combined flexibility and security with Ship to a UPS Access Point Location, enter a four- to six-digit numerical code when preparing a shipment and provide the code to the person you want to pick it up. The code is known only to you and the person to whom you provide it. 	No charge \$4.90 per package No charge
Direct Delivery Only	<ul style="list-style-type: none"> – Except for shipper requests, where available, the package may not be rerouted, redirected or delivered to an alternate address (except requests to hold for Will Call** at UPS Customer Centers). – Delivery pursuant to UPS's driver release and shipper release procedures is still available. Signature on delivery and delivery to the person specified as the recipient not required. 	\$2.00 per package
REROUTING DELIVERIES		
UPS Delivery Intercept®	<ul style="list-style-type: none"> – As the shipper, you can request that UPS take one of the following actions with your package once you have tendered it to UPS: <ul style="list-style-type: none"> • Return the package to you (additional transportation fees and all applicable surcharges may apply). • Reroute the package to a new address (additional transportation fees and all applicable surcharges may apply). • Have the package available at Will Call** for pickup (no charge for Will Call). • Have the package delivered on a future date. – When the package is tracked, the status of the UPS Delivery Intercept request will be displayed. – Shippers can make a UPS Delivery Intercept request electronically through the Shipping History with WorldShip® or UPS CampusShip® shipping systems, ups.com shipping, Quantum View Manage® or UPS tracking on ups.com. – A UPS Delivery Intercept request can also be made by calling 1-800-PICK-UPS® (1-800-742-5877). 	\$18.60 per package (Web/Electronic) \$25.90 per package (Phone)

*Hold for Pickup available only at select UPS Customer Centers.

**Will Call available only at select UPS Customer Centers.

Notes:

– The value-added services listed are available for UPS domestic, international package and UPS Worldwide Express Freight® services unless otherwise noted on page 114. Unless otherwise noted, UPS rates are per package for domestic services and per shipment for international services.

– Fuel surcharges apply to value-added services associated with pickup, transport and delivery. For current fuel surcharges, where applicable, visit [ups.com/fuelsurcharge](https://www.ups.com/fuelsurcharge).

Domestic, Export and Import Value-Added Services – Pickup Options

PACKAGE

Available Options	Description	Fee
SCHEDULED PICKUP OPTIONS		
One UPS® driver will pick up all your packages – air, international and domestic services. Scheduled pickup options are restricted to Monday through Friday. For Saturday pickup options, refer to the Weekend Services section on page 119. Several scheduled pickup options are available:		
Daily Pickup* – Pickup Every Weekday (Premium Option)	– A UPS driver attempts a pickup at your location once each business day as scheduled, typically after 2:00 p.m.	Weekly Pickup Fee Daily Pickup:* \$32.90
Daily On-Route Pickup – Flexible Daily Pickup (Standard Option)	– A UPS driver attempts a pickup at your location once each business day while making deliveries in your area, even if there are no packages delivered to your location. Pickups typically occur between 10:00 a.m. and 3:00 p.m.	Daily On-Route Pickup: \$9.90
UPS Smart Pickup*** – Pickup When You Need It (Economy Option)	– Automatically arrange a pickup only when you have packages to ship. A UPS driver will attempt a pickup the same business day when a package is tendered before a predetermined cut-off time. Pickups typically occur after 1:30 p.m. – When you process a shipment using WorldShip® or UPS CampusShip® shipping systems, or ups.com shipping, the system automatically notifies a UPS driver to make a UPS Smart Pickup service request that same day.	UPS Smart Pickup:** \$16.90
Day-Specific Pickup – Choose Your Pickup Day (Custom Option)	– Select which days of the week, Monday through Friday, you would like UPS to attempt a scheduled pickup. UPS will only stop at your location those days as scheduled, typically after 2:00 p.m. – The weekly service fee will vary based on the number of pickup days selected.	Day-Specific Pickup: – 1 day: \$6.90 – 2 days: \$12.90 – 3 days: \$18.90 – 4 days: \$24.90
ONE-TIME PICKUP REQUEST		
UPS On-Call Pickup® – One-Time Pickup (Occasional Option)	– With one pickup request, UPS will pick up all of your packages at a location of your choosing (not limited to home or office). Schedule a same-day or future-day pickup via ups.com or by calling 1-800-PICK-UPS® (1-800-742-5877). – Fees are applied per pickup request regardless of the number of packages being picked up. – Residential, area and fuel surcharges may apply. – Scheduled pickup options are not available for UPS Worldwide Express Freight® Midday and UPS Worldwide Express Freight® shipments. UPS On-Call Pickup requests for these two services must be requested using WorldShip, UPS CampusShip, ups.com shipping, UPS Ready® solution, UPS® Developer Kit, ups.com or by calling 1-800-782-7892. – For a complete listing of all UPS On-Call Pickup related charges, see the Appendix on page 150.	Same-Day Pickup: \$13.90 Future-Day Pickup: \$8.50

*UPS reserves the right in its sole and unlimited discretion to shift accounts at locations that ship four or fewer times per week from Daily Pickup to UPS Smart Pickup.

**UPS reserves the right in its sole and unlimited discretion to shift accounts at locations that ship four or more times per week from UPS Smart Pickup to Daily Pickup. UPS also reserves the right in its sole and unlimited discretion to shift accounts that do not process shipments using WorldShip, UPS CampusShip or ups.com shipping from UPS Smart Pickup to Daily Pickup.

Notes:

- The value-added services listed are available for UPS domestic, international package and UPS Worldwide Express Freight® services unless otherwise noted on page 114. Unless otherwise noted, UPS rates are per package for domestic services and per shipment for international services.
- Fuel surcharges apply to value-added services associated with pickup, transport and delivery. For current fuel surcharges, where applicable, visit [ups.com/fuelsurcharge](https://www.ups.com/fuelsurcharge).

Domestic, Export and Import Value-Added Services – Weekend Services

PACKAGE

UPS offers comprehensive weekend pickup and delivery for businesses that operate, ship or receive packages on Saturdays, or those that want their outbound shipments delivered to customers on the weekend.

Available Options	Description	Fee
SATURDAY PICKUP SERVICE		
UPS offers four Saturday pickup options to accommodate your business's weekend operating schedule. One UPS driver will pick up all your packages – air, domestic and international.		
Saturday Stop Charge	– Your Saturday pickup type must match your Monday through Friday pickup type. The fees listed below are in addition to any weekly scheduled pickup fees and will apply any time a Saturday pickup is requested.	
Scheduled Pickup	– A UPS driver attempts a pickup at your location every Saturday. – With a Saturday Scheduled Pickup, customers are eligible to opt in for Saturday Commercial Delivery at no additional charge.	\$12.00 per stop
UPS Smart Pickup®	– A UPS driver attempts a pickup at your location when you process a shipment on Saturday in an eligible shipping system before a predetermined cut-off time.	\$8.00 per stop
UPS On-Call Pickup®	– A UPS driver attempts a pickup at your location when you schedule a one-time Saturday pickup via ups.com on or prior to Saturday. This Saturday Stop Charge will apply in addition to the applicable UPS On-Call Pickup Charge.	\$6.00 per stop
SATURDAY AIR AND EXPORT PROCESSING		
Saturday Air Processing Fee	– Your eligible Air packages picked up on Saturday will be delivered the next business day.	Additional Fees: \$16.00 per package
Saturday Export Processing Fee	– Your eligible International packages picked up on Saturday will clear customs one day earlier.	\$16.00 per International shipment
WEEKEND COMMERCIAL DELIVERY SERVICE		
Saturday Delivery (To your business)	– If your business has a Saturday Scheduled Pickup, you can opt in to receive UPS® Ground and UPS 3 Day Select® deliveries on Saturdays at the time of pickup for no additional charge.	No additional fee (Saturday Scheduled Pickup and recipient opt-in required)
Saturday Delivery (To your business customers)	– If your business customer does not have a UPS Saturday Scheduled Pickup and/or has not opted in to receive Saturday deliveries, you can still have your outbound UPS Ground and UPS 3 Day Select shipments delivered to them on Saturdays by paying the UPS Ground/UPS 3 Day Select Commercial Delivery fee below. Air and International shipments can also be delivered to your business customers on Saturdays for the fees listed below. These are transactional fees paid for at the time you generate the shipping label.	
UPS Ground/ UPS 3 Day Select – Commercial Delivery (Shipper-Driven)	– Saturday delivery of eligible UPS Ground and UPS 3 Day Select shipments to your business customers.	Additional Fees: – \$4.00 per UPS Ground and UPS 3 Day Select package – \$4.00 per shipment of UPS® Ground with Freight Pricing
Air and International – Commercial Delivery (Shipper-Driven)	– Guaranteed Saturday delivery of eligible Air and International shipments to your business customers.	– \$16.00 per Air package – \$16.00 per International shipment – \$200.00 per UPS Worldwide Express Freight® shipment
WEEKEND RESIDENTIAL DELIVERY SERVICE		
Weekend Delivery (To your residential customers)	– Your eligible outbound packages will be delivered to residential addresses on the weekend.	
Weekend Residential Delivery	– Eligible International, Air and Ground packages will be delivered by UPS to residential addresses on Saturday.	No additional fee for Ground and UPS 3 Day Select – \$16.00 per Air package – \$16.00 per International shipment
UPS SurePost® Weekend Residential Delivery	– Eligible UPS SurePost packages will be delivered by the USPS to residential addresses on Saturday and Sunday.	No additional fee (UPS SurePost is a contractual service)

Notes:

- The value-added services listed are available for UPS domestic, international package and UPS Worldwide Express Freight® services unless otherwise noted on page 114. Unless otherwise noted, UPS rates are per package for domestic services and per shipment for international services.
- Fuel surcharges apply to value-added services associated with pickup, transport and delivery. For current fuel surcharges, where applicable, visit [ups.com/fuelsurcharge](https://www.ups.com/fuelsurcharge).

Domestic, Export and Import Value-Added Services – Return Services

PACKAGE

Available Options	Benefits for Your Customer			Fee
UPS RETURNS® SERVICES				
UPS offers a comprehensive suite of returns solutions so that you can design the best experience for your customer. When creating a return shipping label, UPS offers several convenient ways to provide a return shipping label to your customer, as outlined below.				
	No return authorization needed	No printer needed	No need to leave home (B2C)	Cost per label
Print Return Label (Label Sent by You) Option 1: You print and include a return label in your outbound shipment. Your customer packs the item, applies the label and gets it to UPS.	✓	✓	*	\$1.05
Option 2: You provide a PDF return label to your customer upon request via your website or returns portal. Your customer packs the item, prints and applies the label and gets it to UPS.			*	\$1.05
Electronic Return Label (Label Sent by UPS via Email) UPS emails a return label and mobile barcode directly to your customer. Your customer prints the return label or brings the mobile barcode to any The UPS Store® location, where it is scanned and the label is printed for them.		✓	*	\$1.05
1 UPS Pickup Attempt (Label Provided by UPS Driver) UPS prints a return label, and a UPS driver makes one attempt to collect the return package.		✓	✓	\$6.50
3 UPS Pickup Attempts (Label Provided by UPS Driver) UPS prints a return label, and a UPS driver makes three attempts to collect the return package.		✓	✓	\$8.90
Contractual Return Services (Varies by Service) Additional UPS Returns Services are available on a contractual basis. UPS offers “No-Box and No-Label Returns” through direct API integration and select third-party partners. Contact your account representative to learn more.	Varies by service	Varies by service	Varies by service	Varies by service

GENERAL INFORMATION ON UPS RETURNS SERVICES
<ul style="list-style-type: none"> – Return packages must be UPS compatible, conforming to UPS packaging guidelines and fall within UPS size and weight limits. – Shipments containing certain items including, but not limited to, Hazardous Materials or Dangerous Goods requiring shipping papers, are not allowed in UPS Returns Services. – Transportation charges for return packages are billed after the package enters the UPS system. – 1 UPS Pickup Attempt Label, 3 UPS Pickup Attempts Label and UPS Returns Exchange accessorial fees are billed at the time of request. – UPS Returns Print Return Label and Electronic Return Label fees are billed after the package enters the UPS system. – UPS Automated Shipping Systems will allow you to produce a commercial invoice along with the label for international returns shipments. – UPS Returns Services facilitate the pickup of return shipments and their delivery in over 145 countries and territories. Specific details may vary by country. – The exporter will be responsible for meeting export/import documentation requirements, regardless of who processes a shipment. – Regulations and requirements for documentation for individual commodities vary from country to country. See Export and Import rules on ups.com for country-specific rules. – Refer to the “UPS Tariff/Terms and Conditions of Service – United States” available at ups.com/termsandservice for limits on actual and declared value for UPS Returns Services shipments. – UPS provides third-country returns (where the international shipment is to be returned to a country other than the exporter’s or processing party’s country) only as a contractual service. – UPS Returns Service options for UPS® Simple Rate are limited to UPS Print Return Label Service only.

*Can be combined with a UPS On-Call Pickup® for an additional cost. See pages 118-119 for details on pickup options.

Notes:

- The value-added services listed are available for UPS domestic, international package and UPS Worldwide Express Freight® services unless otherwise noted on page 114. Unless otherwise noted, UPS rates are per package for domestic services and per shipment for international services.
- Fuel surcharges apply to value-added services associated with pickup, transport and delivery. For current fuel surcharges, where applicable, visit [ups.com/fuelsurcharge](https://www.ups.com/fuelsurcharge).

Domestic, Export and Import Value-Added Services – Other Services

PACKAGE

Available Options	Description	Fee
OTHER SERVICES – GENERAL		
Declared Value for Carriage	<ul style="list-style-type: none"> – UPS's liability for loss or damage for each domestic package or international shipment, or to each pallet in a UPS Worldwide Express Freight® Midday or UPS Worldwide Express Freight® shipment, is limited to \$100.00 without a declaration of value. – UPS's liability for loss or damage can be increased up to \$50,000.00 per package or \$100,000.00 per pallet by making a declaration of value for an additional charge (subject to terms and conditions). Certain domestic packages are eligible for the enhanced maximum declared value of \$70,000.00, subject to restrictions set forth in the "UPS Tariff/Terms and Conditions of Service – United States" available at ups.com/termservice and also set forth in "Maximum Declared Values" on page 8. – Declarations of value from \$100.01 to \$300.00 are subject to a charge of \$4.35. Declarations of value over \$300.00 incur a charge for each \$100.00 (or portion of \$100.00) of the total value declared, including the first \$100.00. For example, a declaration of \$950.00 value incurs a charge of \$14.50 (10 times \$1.45). – For international shipments with a declared value of more than \$50,000.00, multiply the total declared value by the rate to determine the declared value charge for the shipment. – For packages tendered to a UPS driver with a declared value amount of more than \$1,000.00, the shipper must retain a high-value shipment summary signed by the driver. The UPS Shipping System provides this form when the shipping label is requested. – Declared value charges can be included in charges billed to receivers or third parties. 	<ul style="list-style-type: none"> – Value from \$0.00 to \$100.00 No charge – Value from \$100.01 to \$300.00 \$4.35 – Value over \$300.00, charge \$1.45 for each \$100.00 (or portion of \$100.00) of the total value declared (from \$0.00 to total value declared) – For international shipments with a declared value of more than \$50,000.00 \$0.0145 times the declared value
UPS carbon neutral	<ul style="list-style-type: none"> – UPS calculates the CO2 emissions associated with the transport of your package and purchases carbon offsets to balance the impact. – The shipping label will include a carbon neutral indicator. If you select email notifications, your recipient will receive a UPS carbon neutral branded email. – Available to customers using a UPS automated shipping system. 	Per package charge: <ul style="list-style-type: none"> – UPS Domestic Air Services and UPS 3 Day Select® \$0.20 – UPS® Ground and UPS® Standard \$0.05 – UPS International Air Services and UPS 3 Day Select® from Canada \$0.75 – UPS Worldwide Express Freight Services (per pallet) \$20.00
Proof of Delivery (P.O.D.)	<ul style="list-style-type: none"> – Proof of Delivery for a shipment, also known as a physical or electronic Delivery Notification, can be requested after the shipment has been delivered by calling 1-800-PICK-UPS® (1-800-742-5877). – Proof of Delivery includes the time of delivery, full delivery address, and the name and signature of the person who accepted your shipment, if available. – Information can be provided via email, fax or mail and is subject to a charge which will be assessed to the shipper. – Similar information is available for no charge when you track your shipment at ups.com. 	\$3.00 per package
Branded Tracking from UPS	<ul style="list-style-type: none"> – A turn-key solution that merges UPS tracking with your company's branding to help re-engage customers and promote sales. – Create a custom shipment tracking page that looks like your website but is hosted by UPS. – Easy to set up and start quickly. – Learn more at Branded Tracking from UPS. 	Contractual service \$9.99/month
UPS® Premier	<ul style="list-style-type: none"> – Proactive monitoring and intervention service for UPS Next Day Air®, UPS Next Day Air® Early and UPS Next Day Air Saver® shipments. – UPS provides 24/7 support for these shipments. – Intervention is available for these shipments to help ensure service commitments and shipment integrity. – Ideal for customers shipping critical high-value, time- or temperature-sensitive products that require an additional layer of protection. 	Contractual service
Third Party Billing Service	<ul style="list-style-type: none"> – A fee applies to any shipment billed to a third party (regardless of the country of origin or destination of the shipment) and will be charged to the payer. – Based upon all charges, including transportation and accessorial. Excludes duties and taxes assessed by government authorities. – Does not apply to UPS Returns® Services or UPS Import Control® shipments. – UPS® Simple Rate does not qualify for Third Party Billing service. 	5.0% of total charges

Notes:

- The value-added services listed are available for UPS domestic, international package and UPS Worldwide Express Freight services unless otherwise noted on page 114. Unless otherwise noted, UPS rates are per package for domestic services and per shipment for international services.
- Fuel surcharges apply to value-added services associated with pickup, transport and delivery. For current fuel surcharges, where applicable, visit [ups.com/fuelsurcharge](https://www.ups.com/fuelsurcharge).

Domestic, Export and Import Value-Added Services – Other Services

PACKAGE

Available Options	Description	Fee
OTHER SERVICES SPECIFIC TO INTERNATIONAL, EXPORT AND IMPORT PACKAGES		
Duty and Tax Forwarding	– If the duties and/or taxes are billed outside the destination country, a Duty and Tax Forwarding charge will be applied.	\$15.00 per shipment
Currency Conversion Rate	– Charges to a payer's account in a foreign currency will be converted to the payer's currency using a weekly exchange rate secured through major money center banks.	0.75% of currency amount converted
Non-Resident Importer (NRI)	<ul style="list-style-type: none"> – Applicable when shipping to Canada via UPS Air or UPS® Ground shipments. – A Non-Resident Importer is a shipper in the U.S. who acts as the importer of record to the Canadian government. – An NRI account allows you to pay the duties, taxes and brokerage charges for shipments to Canada, simplifying the experience for your recipient. – Shipper files the Power of Attorney (clearance authorization) with UPS for clearance of goods in Canada and is responsible for the payment of all Canadian duties, taxes and brokerage fees. – UPS will automatically charge all Canadian duties, taxes and brokerage fees to the shipper's NRI brokerage account. – Recipient is not involved in the customs clearance process. – Shipper undertakes all importing responsibilities as required by Canadian law. – Shipper must maintain records on all importation into Canada for a period of time prescribed by the Canadian government (for U.S. NRI account holders, that period is six years). – NRI option can be utilized on UPS Air or UPS Ground shipments. – Contact your UPS representative if you would like to set up an NRI account. 	No charge
Certificate of Origin	– Can be prepared by UPS on behalf of the shipper for exported goods manufactured and originating within the U.S.	\$10.00 per shipment
Electronic Export Information (E.E.I.)	<ul style="list-style-type: none"> – UPS can file E.E.I. on your behalf when all required data is provided with the proper Power of Attorney. – Providing E.E.I. as part of a shipment using WorldShip®, UPS CampusShip® or ups.com shipping systems ensures that UPS has all the information to file E.E.I. in a timely manner. – File E.E.I. free of charge at cbp.gov/ace, the U.S. Government website designed for U.S. export shippers. 	\$15.00 per shipment

Notes:

- The value-added services listed are available for UPS domestic, international package and UPS Worldwide Express Freight® services unless otherwise noted on page [114](#). Unless otherwise noted, UPS rates are per package for domestic services and per shipment for international services.
- Fuel surcharges apply to value-added services associated with pickup, transport and delivery. For current fuel surcharges, where applicable, visit ups.com/fuelsurcharge.

Domestic, Export and Import

Value-Added Services – Other Services

PACKAGE

Available Options	Description	Fee
OTHER SERVICES SPECIFIC TO INTERNATIONAL, EXPORT AND IMPORT PACKAGES		
UPS Import Control®	<ul style="list-style-type: none"> – Importers initiate UPS shipments from another country, having it delivered to themselves or an alternate location. – Allows importers to use a UPS automated shipping system or their own system to generate labels and commercial invoices, which can be forwarded to a supplier/exporter in another country by email, mail or via a UPS driver with a pickup dispatch. – Includes import document preparation, pickup, customs clearance, visibility and delivery. – Facilitates pickup/delivery in over 145 countries and territories; varies by country; transportation charges based upon the scheduled delivery date. – Exporter will be responsible for meeting export/import documentation requirements; to facilitate export, exporter may receive an Instruction Sheet with every label delivered to them. – Shipments containing certain items including, but not limited to, Hazardous Materials or Dangerous Goods requiring shipping papers, are not allowed in UPS Import Control shipments. – Transportation charges for return packages are billed after entering the UPS system. – 1 UPS Pickup Attempt Label and 3 UPS Pickup Attempts Label accessorial fees are billed at the time of request. Print Label and Electronic Label fees are billed after the package enters the UPS system. – Regulations and requirements for documentation for individual commodities vary from country to country. See ups.com for country-specific rules. – Shipments with a package or pallet valued greater than \$1,000.00 (or local equivalent) must include a high-value shipment summary from the exporter with the labels and must be signed by the driver. 	
Print Label	– You generate the label(s) and distribute to your customer, who applies it to the shipment.	\$1.05 per label
Electronic Label	– UPS emails the label(s) upon request to your customer, who then prints and applies the label(s) to the shipment.	\$1.05 per label
1 UPS Pickup Attempt Label	– UPS delivers a shipping label to your customer and collects the shipment. If the shipment cannot be picked up on the first attempt, UPS will leave the label at the pickup location.	\$6.50 per label
3 UPS Pickup Attempts Label*	– UPS delivers a shipping label to your customer and collects the shipment. If the shipment cannot be picked up on the first attempt, UPS will make two more pickup attempts over the next two business days.	\$8.90 per label
Invoice Removal	– UPS removes the commercial invoice prior to delivery, which keeps merchandise values confidential from the final recipient.	\$20.00 per shipment
World Ease®	<ul style="list-style-type: none"> – Simplifies customs clearance and reduces cost by grouping several shipments destined for one country or the entire European Union into a single shipment. – Multiple shipments travel together until customs clearance, reducing documentation and saving time. Transit times may vary from traditional single-shipment transit times. – Available to and from over 78 countries and territories. – Offers detailed tracking visibility for every package in the shipment. – Call 1-800-782-7892 for more information. 	Contractual service

*Not available for UPS Worldwide Express Freight® Services.

Notes:

- The value-added services listed are available for UPS domestic, international package and UPS Worldwide Express Freight® services unless otherwise noted on page 114. Unless otherwise noted, UPS rates are per package for domestic services and per shipment for international services.
- Fuel surcharges apply to value-added services associated with pickup, transport and delivery. For current fuel surcharges, where applicable, visit [ups.com/fuelsurcharge](https://www.ups.com/fuelsurcharge).

Domestic, Export and Import Value-Added Services – Recipient Services

PACKAGE

Available Options	Description	Fee
RECIPIENT SERVICES – GENERAL		
Delivery Change Request	– After receiving notice that the first delivery attempt has occurred or after receiving an automatic email notification, recipient may provide new delivery instructions to UPS for a package or pallet.	No charge
	– These instructions can include:	
	• Where to leave a package, including the option of leaving with a neighbor (within walking distance of the original address)	
	• Return to the sender*	
	• Reschedule delivery to a future date	
	• Change a domestic package's delivery location (but not a pallet's)*	
	• Deliver* an eligible domestic package to a UPS Access Point® Location**	
	• Redeliver to the original address a package that was taken to a UPS Access Point Location without the recipient's request	
• Hold a package for Will Call*** at a UPS Customer Center	No charge	
– For domestic packages and import shipments only. – Recipients can submit requests by using their automatic email notification, the tracking application on ups.com . A UPS InfoNotice® number is required to change the destination delivery address. – Fees will be charged to the recipient making the request, and the charge will be the same whether the request is made online or over the phone.		

*Additional transportation fees and all applicable surcharges may apply. For requests to return to the sender, any such fees will be assessed to the shipper. Refer to the "UPS Tariff/Terms and Conditions of Service – United States" available at [ups.com/termservice](https://www.ups.com/termservice) for more information.

**Where available – refer to the "UPS Tariff/Terms and Conditions of Service – United States" available at [ups.com/termservice](https://www.ups.com/termservice).

***Will Call available only at select UPS Customer Centers.

Notes:

- The value-added services listed are available for UPS domestic, international package and UPS Worldwide Express Freight® services unless otherwise noted on page 114. Unless otherwise noted, UPS rates are per package for domestic services and per shipment for international services.
- Fuel surcharges apply to value-added services associated with pickup, transport and delivery. For current fuel surcharges, where applicable, visit [ups.com/fuelsurcharge](https://www.ups.com/fuelsurcharge).

Domestic, Export and Import

Value-Added Services – Recipient Services

PACKAGE

Available Options	Description	Fee	
RECIPIENT SERVICES – UPS MY CHOICE			
UPS My Choice®	– A web-based platform designed to help residential recipients manage home deliveries (online or via mobile app). – Helps shippers to ensure delivery on the first attempt, maintain superior customer service, reduce tracking calls and returns, and improve the online purchasing experience. – Delivers proactive alerts via text*, email or UPS® Mobile App push notifications. – Provides an online Delivery Planner to help manage and track recipients' home deliveries. – Offers delivery information, typically a four-hour approximate delivery time. – Allows recipients to give authorization online for UPS to deliver packages without a signature. – Follow My Delivery (FMD), a map-based tracking notification sent the morning of delivery, enables you to track premium and UPS® Ground package deliveries in real time. – The following Delivery Change Requests are available for packages:	Free	
	• Provide delivery instructions on where to leave a package, including the option of leaving it with a neighbor (within walking distance of the original address)	No charge	
	• Return a package to the sender**	No charge	
	• Redeliver to the original address a package that was taken to a UPS Access Point® Location without the recipient's request	No charge	
	• Reschedule package delivery to a future date	\$9.99 per package	
	• Upgrade UPS SurePost® service*** to UPS Ground	\$7.99 per package	
	• Deliver** an eligible domestic package to a UPS Access Point Location†	\$5.99 per package	
	• Hold a package for Will Call†† at a UPS Customer Center	No charge	
	• Change a domestic package's delivery location**	\$14.99 per package	
	• Set a vacation hold to have eligible domestic packages held at a UPS Access Point Location – Pick up the packages after the vacation ends – Have packages delivered after the vacation ends**	No charge \$9.99 per package	
	• Select a two-hour confirmed delivery window	\$14.99 per shipment	
	UPS My Choice® Premium†††	– Includes all of the features of UPS My Choice, plus added Delivery Change Requests at no charge. Delivery Change Requests include:	\$19.99 annual fee
		• Reschedule package delivery to a future date	No additional charge
		• Upgrade UPS SurePost service*** to UPS Ground	No additional charge
• Deliver** an eligible domestic package to a UPS Access Point Location†		No additional charge	
• Hold a package for Will Call†† at a UPS Customer Center		No additional charge	
• Change a domestic package's delivery location**		No additional charge	
• Set a vacation hold and have all packages delivered** on one of the three business days after the vacation ends		No additional charge	
• Select a two-hour confirmed delivery window	Two free confirmed delivery window (two-hour) requests included annually		

*Your carrier's standard message and data rates may apply.

**Additional transportation fees and all applicable surcharges may apply. For requests to return to the sender, any such fees will be assessed to the shipper. Refer to the "UPS Tariff/Terms and Conditions of Service – United States" available at [ups.com/termsandservice](https://www.ups.com/termsandservice) for more information.

***UPS SurePost is a contract-only, non-guaranteed economy residential service with final delivery typically provided by the U.S. Postal Service.

† Where available – refer to the "UPS Tariff/Terms and Conditions of Service – United States" available at [ups.com/termsandservice](https://www.ups.com/termsandservice).

†† Will Call available only at select UPS Customer Centers.

††† Annual subscriptions for UPS My Choice Premium will renew automatically at end of term at then-current rate, plus applicable taxes, unless customer cancels subscription before end of the term. To cancel subscription, call 1-800-PICK-UPS® (1-800-742-5877), or access UPS My Choice Premium account by visiting [ups.com/mychoice](https://www.ups.com/mychoice) to update membership settings.

Notes:

– The value-added services listed are available for UPS domestic, international package and UPS Worldwide Express Freight® services unless otherwise noted on page 114. Unless otherwise noted, UPS rates are per package for domestic services and per shipment for international services.

– Fuel surcharges apply to value-added services associated with pickup, transport and delivery. For current fuel surcharges, where applicable, visit [ups.com/fuelsurcharge](https://www.ups.com/fuelsurcharge).

Domestic, Export and Import Value-Added Services – Recipient Services

PACKAGE

Available Options	Description	Fee
RECIPIENT SERVICES – UPS MY CHOICE FOR BUSINESS		
UPS My Choice® for Business	<ul style="list-style-type: none"> – A web-based platform that serves as a touchpoint to discover, connect and manage select UPS business services, including better control and visibility into shipments from a customizable dashboard. – Learn more and enroll any time at: ups.com/mychoiceforbusiness. – Features include: <ul style="list-style-type: none"> • View, at a glance, inbound, outbound and third-party shipments with interactive dashboards to easily track shipments • Filter by date, shipment characteristics or accounts with updates from label creation to delivery • View current shipment status to provide more accurate timing to customers and help resolve any issues • Set notification preferences to get automatic status alerts, including the day before and day of delivery • Enable additional users within your organization to access important visibility information • Connect to additional business services like Claims, UPS Returns® Manager and Branded Tracking from UPS • Select dates that your business does not require pickup service* • Initiate UPS Delivery Intercept® requests as detailed on page 117 – The following Delivery Change Requests are available for packages: <ul style="list-style-type: none"> • Return to the sender** 	Free
	<ul style="list-style-type: none"> • Reschedule delivery to your business to a future date 	No charge
	<ul style="list-style-type: none"> • Redeliver to the original address a package that was taken to a UPS Access Point® Location without the recipient's request 	No charge
	<ul style="list-style-type: none"> • Change a domestic package's delivery location** 	\$14.99 per package
	<ul style="list-style-type: none"> • Deliver** an eligible domestic package to a UPS Access Point Location*** 	\$5.99 per package
	<ul style="list-style-type: none"> • Hold a package for Will Call† at a UPS Customer Center 	No charge
RECIPIENT SERVICES – NON-UPS MY CHOICE FOR HOME OR NON-UPS MY CHOICE FOR BUSINESS RECIPIENTS		
UPS Automatic Alerts for Non-UPS My Choice Members	<ul style="list-style-type: none"> – When a shipper includes the package recipient's email address in the shipping information, the recipient will receive a notification by email with an estimated date of delivery. When available, UPS will include an estimated delivery window† when the package will be delivered. – Different types of automatic notifications listed below are sent when notification conditions are met: <ul style="list-style-type: none"> • Automatic Ship Notification: notifies the recipient that the package has shipped • Automatic Delivery Schedule Update: notifies the recipient only when the planned delivery date has changed • Automatic Day-Before Delivery: notifies the recipient that a package is scheduled to be delivered the following day • Automatic Day of Delivery: notifies the recipient the same day when the package is out for delivery • Automatic Pre-Alert Notification: notifies the recipient when the package is expected to arrive within the next 1-3 hours • Automatic Delivered Notification: notifies the recipient when the package has been delivered 	Free

*Should you decide to reinstate pickup service, ensure you do so at least three business days before your desired pickup date to resume regular pickup service. To reinstate UPS Smart Pickup® service, you will also need to process a shipment using the WorldShip® UPS CampusShip® shipping systems, or ups.com shipping to ensure your reinstatement takes effect. If your request is within two business days of your desired pickup date, schedule a UPS On-Call Pickup®, which is subject to an additional fee as set forth in the UPS Rate and Service Guide.

**Additional transportation fees and all applicable surcharges may apply. For requests to return to the sender, any such fees will be assessed to the shipper. Refer to the "UPS Tariff/Terms and Conditions of Service – United States" available at ups.com/termsofservice for more information.

***Where available – refer to the "UPS Tariff/Terms and Conditions of Service – United States" available at ups.com/termsofservice.

† Will Call available only at select UPS Customer Centers.

†† Delivery windows are based on varying scheduled delivery patterns and do not constitute a guarantee that packages will always be delivered as scheduled. Refer to the "UPS Tariff/Terms and Conditions of Service – United States" available at ups.com/termsofservice.

Notes:

- The value-added services listed are available for UPS domestic, international package and UPS Worldwide Express Freight® services unless otherwise noted on page [114](#). Unless otherwise noted, UPS rates are per package for domestic services and per shipment for international services.
- Fuel surcharges apply to value-added services associated with pickup, transport and delivery. For current fuel surcharges, where applicable, visit ups.com/fuelsurcharge.

Domestic, Export and Import

Other Charges

PACKAGE

Charges	Description	Fee																												
Additional Handling	<p>– An Additional Handling charge will be assessed for any package that requires special handling, as determined by UPS in its sole discretion, including, but not limited to:</p> <ul style="list-style-type: none"> • Weight: <ul style="list-style-type: none"> – Domestic: Any package with an actual weight of more than 50 pounds. – Each package in a shipment where the average weight per package is greater than 50 pounds and the weight for each package is not specified on the source document or the UPS automated shipping system used. – International: Any package with an actual weight of more than 55 pounds. – Each package in a shipment where the average weight per package is greater than 55 pounds and the weight for each package is not specified on the source document or the UPS automated shipping system used. • Length plus girth: Any package with its length (longest side of the package) plus girth [(2 x width) + (2 x height)] combined exceeding 105 inches. • Length: Any package with the longest side exceeding 48 inches. • Width: Any package with its second-longest side exceeding 30 inches. • Packaging/other: <ul style="list-style-type: none"> – Any article that is not fully encased in a corrugated cardboard shipping container, including tires. – Any package with an outer shipping container not made of corrugated cardboard, including but not limited to canvas, leather, metal, wood, hard plastic, soft plastic (e.g., plastic bag) or expanded polystyrene foam (e.g., styrofoam). – Any article that is encased in a soft-sided pack (e.g., poly bags and bubble mailers) that exceeds 18 inches along its longest side or 14 inches along its second-longest side or 6 inches in height. – Any package with an outer shipping container covered in shrink wrap or stretch wrap. – Any package bound with metal, plastic or cloth banding, or that has wheels, casters, handles or straps (including packages where the outer surface area is loosely wrapped or where the contents protrude outside the container surface). – Any cylindrical-like item, including but not limited to barrels, buckets, cans, drums, mailing tubes or pails. – Any package routed through UPS's irregular package sortation process, including but not limited to packages 1 inch or less in height. – Any other package that requires special handling, as determined by UPS in its sole discretion. <p>– Applies per package for both domestic and international services.</p> <p>– For a package that meets multiple criteria listed above, only one Additional Handling charge will be assessed, in the following order: Weight, Length plus girth, Length, Width, Packaging.</p> <p>– An Additional Handling charge will not be assessed when a Large Package Surcharge is applied.</p>	<table border="1"> <thead> <tr> <th>Domestic</th> <th>Zone 2</th> <th>Zones 3-4</th> <th>Zones 5+</th> </tr> </thead> <tbody> <tr> <td>– Weight</td> <td>\$34.50</td> <td>\$37.50</td> <td>\$41.50</td> </tr> <tr> <td>– Length + girth</td> <td>\$22.00</td> <td>\$24.50</td> <td>\$28.25</td> </tr> <tr> <td>– Length</td> <td>\$22.00</td> <td>\$24.50</td> <td>\$28.25</td> </tr> <tr> <td>– Width</td> <td>\$22.00</td> <td>\$24.50</td> <td>\$28.25</td> </tr> <tr> <td>– Packaging</td> <td>\$19.50</td> <td>\$23.00</td> <td>\$24.50</td> </tr> <tr> <td>International</td> <td colspan="3">\$31.00</td> </tr> </tbody> </table>	Domestic	Zone 2	Zones 3-4	Zones 5+	– Weight	\$34.50	\$37.50	\$41.50	– Length + girth	\$22.00	\$24.50	\$28.25	– Length	\$22.00	\$24.50	\$28.25	– Width	\$22.00	\$24.50	\$28.25	– Packaging	\$19.50	\$23.00	\$24.50	International	\$31.00		
Domestic	Zone 2	Zones 3-4	Zones 5+																											
– Weight	\$34.50	\$37.50	\$41.50																											
– Length + girth	\$22.00	\$24.50	\$28.25																											
– Length	\$22.00	\$24.50	\$28.25																											
– Width	\$22.00	\$24.50	\$28.25																											
– Packaging	\$19.50	\$23.00	\$24.50																											
International	\$31.00																													
Address Correction	<p>– If any shipment has an incorrect or incomplete address, UPS will make reasonable efforts to secure the correct or complete address and will make available to the shipper the correct address. UPS may also correct or complete an address based on information obtained from the shipper or consignee. An Address Correction charge will be assessed to the shipper for an address correction or completion.</p> <p>– An address validated by UPS may be incorrect or incomplete for purposes of completing delivery and may be corrected by UPS.</p>	<p>Package and UPS Worldwide Express Freight® Services \$21.00</p> <p>UPS® Ground with Freight Pricing \$21.00 per package up to a maximum of \$147.00 per shipment</p>																												
Chargeback for Consignee Billing Shipments	<p>– In the event of non-payment by the consignee or third party, the original shipper will be billed a refusal fee in addition to the shipping charges.</p>	\$21.00																												

Notes:

- The other charges listed are available for UPS domestic, international package and UPS Worldwide Express Freight® services unless otherwise noted on page [115](#). Unless otherwise noted, UPS rates are per package for domestic services and per shipment for international services.
- Fuel surcharges apply to other charges associated with pickup, transport and delivery. For current fuel surcharges, where applicable, visit [ups.com/fuelsurcharge](https://www.ups.com/fuelsurcharge).

Domestic, Export and Import

Other Charges

PACKAGE

Charges	Description	Fee															
Dangerous Goods (Hazardous Materials)	<ul style="list-style-type: none"> – UPS accepts Hazardous Materials only from customers with a UPS Dangerous Goods Agreement (contract) in effect and a Scheduled Pickup account, and then for transport only within and between all 50 states and Puerto Rico. – Materials prepared in accordance with Title 49 CFR 173.4 Small Quantities for highway and rail, 173.4a Excepted Quantities, and 173.4b de minimis exceptions; and Excepted Quantities, as defined in the International Air Transport Association (IATA) 2.6, may be shipped without a Hazardous Materials contract in the 50 states and Puerto Rico. – International Dangerous Goods (IDG) shipments requiring "Shipper's Declaration for Dangerous Goods," as defined under the International Civil Aviation Organization (ICAO) and published in the IATA "Dangerous Goods Regulations," are accepted for transportation only as a contractual service. – Excepted Quantities require a contract for IDG service but are not subject to the additional IDG charge. – UPS accepts IDG only for transportation within and between defined international service areas. For valid countries and territories, see ups.com/approvedcountries. – Domestic Air, International Air and UPS Worldwide Express Freight® Services Dangerous Goods are rated based on the class of the commodity being shipped. If a package or shipment contains any Accessible Dangerous Goods commodities or the shipper fails to identify the class of the commodity, the Accessible charge will apply. <ul style="list-style-type: none"> • Accessible Dangerous Goods: Class 1.4 Explosives, Class 2.1 Flammable Gas, Class 2.2 Non-Flammable Gas in Cargo Aircraft Only (CAO) quantities, Class 3 Flammable Liquid, Class 4 Flammable Solid, Dangerous When Wet, Class 5 Oxidizers and Organic Peroxides, and Class 8 Corrosives. • Inaccessible Dangerous Goods: Class 2.2 Non-Flammable Gas in Passenger (PAX) and Limited Quantities (Ltd Qty), Class 6 Toxic and Infectious Substances, Class 7 Radioactive Material, and Class 9 Miscellaneous Dangerous Substances (including Lithium Battery). – For additional information, call the Hazardous Materials Support Center at 1-800-554-9964. – Hazardous Materials are not accepted for transportation using UPS® Simple Rate, UPS Ground with Freight Pricing or UPS Worldwide Expedited® Ground Freight. 	<p>Package</p> <ul style="list-style-type: none"> – UPS® Ground (Fully Regulated and Lithium Battery): \$51.00 – UPS® Standard to/from Canada: the greater of \$59.00 per shipment or \$6.68 per Dangerous Goods package <p>Domestic and International Air Services Accessible Dangerous Goods</p> <ul style="list-style-type: none"> – UPS Domestic Air Services*: \$160.00 per package – UPS International Air Services*: the greater of \$235.00 per shipment or \$28.21 per Dangerous Goods package – UPS Worldwide Express Freight Services: the greater of \$231.50 per shipment or \$1.26 per lb. – Lithium Battery: Domestic \$73.00, International \$114.50 <p>Inaccessible Dangerous Goods</p> <ul style="list-style-type: none"> – UPS Domestic Air Services*: \$73.00 per package – UPS International Air Services*: the greater of \$118.50 per shipment or \$14.24 per Dangerous Goods package – UPS Worldwide Express Freight Services: the greater of \$114.50 per shipment or \$0.63 per lb. 															
Delivery Area Surcharge	<ul style="list-style-type: none"> – A surcharge applies to each package delivered to certain ZIP codes within the 48 contiguous states. For Alaska and Hawaii, refer to page 130 for the Remote Area Surcharge. – Refer to the Area Surcharge Listing at ups.com/rates for a listing of applicable ZIP codes. – Delivery Area Surcharge does not apply to UPS Ground with Freight Pricing or UPS Simple Rate shipments. 	<table> <tr> <td></td> <td>Ground</td> <td>Air*</td> </tr> <tr> <td>– Commercial</td> <td>\$3.95</td> <td>\$3.95</td> </tr> <tr> <td>– Residential</td> <td>\$5.70</td> <td>\$5.85</td> </tr> <tr> <td>– Commercial Extended</td> <td>\$4.90</td> <td>\$4.90</td> </tr> <tr> <td>– Residential Extended</td> <td>\$7.70</td> <td>\$7.70</td> </tr> </table> <p>Import:</p> <ul style="list-style-type: none"> – Delivery Area Surcharge: \$3.85 – Delivery Area Surcharge Extended: \$4.75 		Ground	Air*	– Commercial	\$3.95	\$3.95	– Residential	\$5.70	\$5.85	– Commercial Extended	\$4.90	\$4.90	– Residential Extended	\$7.70	\$7.70
	Ground	Air*															
– Commercial	\$3.95	\$3.95															
– Residential	\$5.70	\$5.85															
– Commercial Extended	\$4.90	\$4.90															
– Residential Extended	\$7.70	\$7.70															
Delivery Reattempt	<ul style="list-style-type: none"> – For UPS Worldwide Express Freight® Midday and UPS Worldwide Express Freight shipments, one delivery attempt is included in the rate. – Additional delivery attempts may have additional charges. 	\$60.00															
Demand Surcharges	<ul style="list-style-type: none"> – One or more Demand Surcharges will apply to certain packages tendered during a Demand Period. Details are available at ups.com/peaksurcharges. The term Demand Surcharges includes Peak/Demand Surcharges and Peak Surcharges, and the terms are used interchangeably. – Refer to the "UPS Tariff/Terms and Conditions of Service – United States" available at ups.com/termsofservice for more information. 	Refer to ups.com/peaksurcharges															
Destination Outside Service Area	<ul style="list-style-type: none"> – If delivery of a UPS Next Day Air® Early package is requested to a destination outside the UPS Next Day Air Early service area, UPS reserves the right to assess an additional fee. 	\$10.00															

*UPS 3 Day Select® shipments receive the charge listed for UPS Domestic Air Services. UPS 3 Day Select from Canada receives the charge listed for UPS International Air Services. References to "Domestic and International Air" in this section include UPS 3 Day Select Services.

Notes:

- The other charges listed are available for UPS domestic, international package and UPS Worldwide Express Freight services unless otherwise noted on page [115](#). Unless otherwise noted, UPS rates are per package for domestic services and per shipment for international services.
- Fuel surcharges apply to other charges associated with pickup, transport and delivery. For current fuel surcharges, where applicable, visit [ups.com/fuelsurcharge](https://www.ups.com/fuelsurcharge).

Domestic, Export and Import Other Charges

PACKAGE

Charges	Description	Fee																																
Dry Ice	<ul style="list-style-type: none"> – Most non-Dangerous Goods shipments containing dry ice are accepted, without requiring the shipper to enter into the UPS Dangerous Goods Agreement (contract). – Prepare and process these packages through WorldShip® or UPS CampusShip® shipping systems, UPS® Developer Kit or an approved UPS Ready® solution. – The International Air Transport Association (IATA) “Shipper’s Declaration for Dangerous Goods” is not required for domestic shipments of non-Dangerous Goods packed in dry ice. Title 49 CFR Shipping Papers are only required for non-medical shipments containing more than 5.5 pounds of dry ice. – International dry ice shipping is available on a contractual basis only. – For more information, visit ups.com or call the Hazardous Materials Support Center at 1-800-554-9964. 	\$7.50 per package																																
Extended Area Surcharge	<ul style="list-style-type: none"> – An Extended Area Surcharge applies to shipments for some international origins and destinations. – Visit ups.com/rates or call 1-800-782-7892 to determine if a particular origin or destination is classified as an Extended Area. 	Greater of \$53.00 per shipment or \$0.53 per lb.																																
Large Package Surcharge	<ul style="list-style-type: none"> – For domestic shipments, a package is considered a “Large Package” when its length (longest side of the package) plus girth [(2 x width) + (2 x height)] combined exceeds 130 inches or its length exceeds 96 inches. – For international shipments, a package is considered a “Large Package” when its length (longest side of the package) plus girth [(2 x width) + (2 x height)] combined exceeds 130 inches. – With the exception of UPS Ground with Freight Pricing packages, Large Packages are subject to a minimum billable weight of 90 pounds. – Applies per package for both domestic and international services. – For a domestic package that meets both criteria listed above, only the Large Package Surcharge applicable when length plus girth combined exceeds 130 inches will be assessed. – An Additional Handling charge will not be assessed when a Large Package Surcharge is applied. 	<table border="1"> <thead> <tr> <th>Domestic</th> <th>Zone 2</th> <th>Zones 3-4</th> <th>Zones 5+</th> </tr> </thead> <tbody> <tr> <td colspan="4">Commercial</td> </tr> <tr> <td>– Length + girth > 130"</td> <td>\$160.00</td> <td>\$175.00</td> <td>\$197.50</td> </tr> <tr> <td>– Length > 96"</td> <td>\$160.00</td> <td>\$175.00</td> <td>\$197.50</td> </tr> <tr> <td colspan="4">Residential</td> </tr> <tr> <td>– Length + girth > 130"</td> <td>\$190.00</td> <td>\$205.00</td> <td>\$235.00</td> </tr> <tr> <td>– Length > 96"</td> <td>\$190.00</td> <td>\$205.00</td> <td>\$235.00</td> </tr> <tr> <td>International</td> <td colspan="3">\$200.00</td> </tr> </tbody> </table>	Domestic	Zone 2	Zones 3-4	Zones 5+	Commercial				– Length + girth > 130"	\$160.00	\$175.00	\$197.50	– Length > 96"	\$160.00	\$175.00	\$197.50	Residential				– Length + girth > 130"	\$190.00	\$205.00	\$235.00	– Length > 96"	\$190.00	\$205.00	\$235.00	International	\$200.00		
Domestic	Zone 2	Zones 3-4	Zones 5+																															
Commercial																																		
– Length + girth > 130"	\$160.00	\$175.00	\$197.50																															
– Length > 96"	\$160.00	\$175.00	\$197.50																															
Residential																																		
– Length + girth > 130"	\$190.00	\$205.00	\$235.00																															
– Length > 96"	\$190.00	\$205.00	\$235.00																															
International	\$200.00																																	
Missing/Invalid Account Number or Refusal Fee	<ul style="list-style-type: none"> – A processing fee will be charged for a missing or invalid account number when the account number is missing, the account number is not the correct number for the bill-to party, the account number is for a receiver or third party who fails to pay the shipping charges, or the package is shipped to an unauthorized consignee. 	\$21.00																																
Missing PLD Fee	<ul style="list-style-type: none"> – A processing fee will be charged when the shipper does not provide all applicable Package Level Detail (PLD) information to UPS prior to delivery. – Applies per package for both domestic and international services. 	\$3.85 per package																																
UPS On-Call Pickup® Area Surcharge	<ul style="list-style-type: none"> – A surcharge applies to each residential UPS On-Call Pickup request at certain ZIP codes within the 48 contiguous states. – Refer to the Area Surcharge Listing at ups.com/rates for a listing of applicable ZIP codes. – Does not apply to UPS On-Call Pickup requests made at commercial addresses. 	<ul style="list-style-type: none"> – Residential: \$5.70 – Extended Residential: \$7.70 																																
Residential Surcharge	<ul style="list-style-type: none"> – A surcharge will apply (in addition to all applicable Area Surcharges) to any UPS On-Call Pickup from a location that is a home, including a business operating out of a home. 	\$5.65																																
Over Maximum Limits	<ul style="list-style-type: none"> – Packages with an actual weight of more than 150 pounds, or that exceed 108 inches in length or exceed a total of 165 inches in length plus girth [(2 x width) + (2 x height)] combined, as measured to determine their billable weight, are not accepted for transportation. – If found in the UPS system, they are subject to additional charges. UPS reserves the right in its sole and unlimited discretion to return such packages to the shipper at the shipper’s expense. – Refer to the “UPS Tariff/Terms and Conditions of Service – United States” available at ups.com/termsofservice for more information. 	\$1,250.00 per package																																
Oversize Pallet Handling Surcharge	<ul style="list-style-type: none"> – UPS Worldwide Express Freight® Midday and UPS Worldwide Express Freight® pallets that exceed maximum size or weight restrictions (which vary by origin and destination) as set forth at ups.com/assets/resources/media/wwef_max_dim.pdf require prior approval and are subject to an Oversize Pallet Handling Surcharge. 	\$1,250.00 per pallet																																
Package Tracking, Tracing and Refund Requests	<ul style="list-style-type: none"> – Shipper may be assessed a charge per request for excessive tracking, tracing and refund requests. 	\$3.00																																

Notes:

- The other charges listed are available for UPS domestic, international package and UPS Worldwide Express Freight services unless otherwise noted on page [115](#). Unless otherwise noted, UPS rates are per package for domestic services and per shipment for international services.
- Fuel surcharges apply to other charges associated with pickup, transport and delivery. For current fuel surcharges, where applicable, visit [ups.com/fuelsurcharge](https://www.ups.com/fuelsurcharge).

Domestic, Export and Import Other Charges

PACKAGE

Charges	Description	Fee
Paper Commercial Invoice Services Surcharge	– Effective December 26, 2023, where a commercial invoice is submitted in connection with a shipment, a fee of up to \$5.00 per shipment will be applied to the shipper when the commercial invoice is not provided by the shipper in digital form using UPS Paperless® Invoice services prior to the processing of the commercial invoice by UPS.	\$5.00 per shipment
Pickup Area Surcharge	– A surcharge applies to each UPS Worldwide Express Freight® Midday or UPS Worldwide Express Freight U.S. export shipment picked up from certain ZIP codes within the 48 contiguous states. – Refer to the Area Surcharge Listing at ups.com/rates or call 1-800-782-7892 for a listing of applicable ZIP codes.	Greater of \$53.00 per shipment or \$0.53 per lb.
Prohibited Item Fee	– Packages containing prohibited articles or restricted articles not in compliance with all UPS policies and procedures and applicable laws and regulations are subject to additional charges if found in the UPS system. – Such charges apply in addition to all other applicable charges. – UPS reserves the right in its sole and unlimited discretion to dispose of such packages, submit such packages to governmental authorities or return such packages to the shipper solely at the shipper's risk and expense. – Refer to the "UPS Tariff/Terms and Conditions of Service – United States" available at ups.com/termservice for more information.	\$150.00 per package
Rebill Fee	– A fee will be assessed for each request to change the billing account for a shipment.	\$21.00 per request
Remote Area Surcharge	– A Remote Area Surcharge applies to deliveries to certain ZIP codes within Alaska, Hawaii, and the 48 contiguous states and select origins and destinations. – Applies to any UPS On-Call Pickup® request made within certain ZIP codes within Alaska, Hawaii and the 48 contiguous states. – Refer to the Area Surcharge Listing at ups.com/rates for a listing of applicable ZIP codes. – Applies to UPS® Simple Rate shipments.	Package – Alaska: \$40.50 – Hawaii: \$14.15 – 48 contiguous states: \$14.15 – Non-U.S. origins and destinations: Greater of \$53.00 per shipment or \$0.53 per lb. UPS Worldwide Express Freight® Services – Alaska/Hawaii/48 contiguous states: Greater of \$53.00 per shipment or \$0.53 per lb. – Non-U.S. origins and destinations: Greater of \$53.00 per shipment or \$0.53 per lb.
Residential Surcharge	– A surcharge will apply (in addition to all applicable Area Surcharges) to any delivery to, or a UPS On-Call Pickup request from, a location that is a home, including a business operating out of a home. – Refer to the "UPS Tariff/Terms and Conditions of Service – United States" available at ups.com/termservice for more information. – Residential Surcharge does not apply to UPS Simple Rate shipments.	Package – UPS Domestic and International Air Services, UPS 3 Day Select® and UPS 3 Day Select® from Canada: \$6.20 – UPS® Ground Services: \$5.65 – UPS® Standard Services: \$5.85 – UPS Ground with Freight Pricing: \$54.45 per shipment UPS Worldwide Express Freight Services – \$200.00
Shipping Charge Correction Audit Fee	– An audit fee will be assessed when the average shipping charge correction during an invoice week is greater than \$2.00 per package subject to a shipping charge correction. – The fee will be calculated per account number, based on shipping charge corrections billed to the account number during the applicable invoice period. – Shipping Charge Correction Audit Fee does not apply to import shipments.	Greater of: – \$1.25 per package subject to a shipping charge correction during the applicable invoice period; or – 6% of the total amount of shipping charge corrections during the applicable invoice period
Special Handling of Undeliverable Shipments	– Domestic packages refused by the consignee, or which are undeliverable for any reason, will be returned to the shipper at the shipper's expense. – Return service level will be UPS 3 Day Select® for Air Services and UPS® Ground for UPS Ground shipments at the applicable rate. Packages in UPS Ground with Freight Pricing shipments will be charged at the applicable rate for single-piece UPS Ground service. All applicable surcharges apply to any return. – The UPS Service Guarantee does not apply to undeliverable packages returned to the shipper.	– UPS Air Services and UPS 3 Day Select: applicable UPS 3 Day Select rate – UPS Ground and UPS Ground with Freight Pricing: applicable UPS Ground rate – All applicable surcharges apply
Undeliverable Shipment Surcharge	– For all international shipments refused by the consignee, or which are undeliverable for any reason, UPS will contact the shipper for further instructions.* – Forwarding costs, return transportation charges, all applicable surcharges, duties, taxes and a return surcharge apply to any return, at the shipper's expense. – The UPS Service Guarantee does not apply to undeliverable packages returned to the shipper.	Applicable costs plus \$10.00 per undeliverable shipment

*For UPS® Standard to Mexico shipments, in cases where the shipment cannot be imported, the shipment will be automatically returned to the exporter.

Notes:

– The other charges listed are available for UPS domestic, international package and UPS Worldwide Express Freight services unless otherwise noted on page 115.
– Unless otherwise noted, UPS rates are per package for domestic services and per shipment for international services.

– Fuel surcharges apply to other charges associated with pickup, transport and delivery. For current fuel surcharges, where applicable, visit ups.com/fuelsurcharge.

Value-Added Services

NORTH AMERICAN FREIGHT

Value-added services are available for the UPS services indicated. For additional information and rates, refer to the pages listed in the “Page” column at right.

	Air Freight						Freight Between the U.S. and Mexico	Page	
	UPS Next Day Air® Freight	UPS Next Day Air/ Air® Freight NGS	UPS 2nd Day Air® Freight	UPS 2nd Day Air/ Air® Freight NGS	UPS 3 Day Freight®	UPS 3 Day Freight® NGS		Air Freight	UPS Worldwide Expedited Ground Freight
Delivery Instructions and Notification / Pickup									
Special Delivery or Pickup Surcharge	●	●	●	●	●	●		133	
Delivery or Pickup Service	●	●	●	●	●	●		133	
Origin or Destination Special Handling Fee	●	●	●	●	●	●		133	
Hold at Destination Airport for Pickup (HAPU)	●	●	●	●	●	●	●	133	136
Proof of Delivery (P.O.D.)	●	●	●	●	●	●	●	133	136
Saturday Delivery	●	●	●	●	●	●		133	
Saturday Pickup	●	●						133	
International Shipping									
Canadian Import Termination Fee	●	●	●	●	●	●		133	
Certificate of Origin	●	●	●	●	●	●	●	133	136
Export Declaration Fee	●	●	●	●	●	●		133	
Free Domicile	●	●	●	●	●	●		133	
Import Service Fee	●	●	●	●	●	●	●	133	136
Navigation Canada Fee	●	●	●	●				133	
U.S. Export Compliance Fee	●	●	●	●	●	●	●	133	136
Additional Options									
Declared Value for Carriage	●	●	●	●	●	●	●	133	136
Constant Surveillance	●	●	●	●	●	●		133	

Other Charges

NORTH AMERICAN FREIGHT

Additional charges may apply to your shipment. For additional information and rates for the UPS services indicated, refer to the pages listed in the "Page" column at right.

	Air Freight						Freight Between the U.S. and Mexico	Page	
	UPS Next Day Air® Freight	UPS Next Day Air® Freight NGS	UPS 2nd Day Air® Freight	UPS 2nd Day Air® Freight NGS	UPS 3 Day Freight®	UPS 3 Day Freight® NGS	UPS Worldwide Expedited® Ground Freight	Air Freight	UPS Worldwide Expedited Ground Freight
Address Correction	•	•	•	•	•	•	•	134	137
Advancement of Charges	•	•	•	•	•	•	•	134	137
Chargeback for Consignee Billed Shipments	•	•	•	•	•	•	•	134	137
Dangerous Goods		•						134	
Detention of Vehicle							•		137
Fee Advance	•	•	•	•	•	•		134	
Liftgate Services	•	•	•	•	•	•	•	134	137
Missing/Invalid Account Number or Refusal Fee	•	•	•	•	•	•	•	134	137
Non-Conforming Freight	•	•	•	•	•	•	•	134	137
NYC Surcharge	•	•	•	•	•	•		134	
Oversize	•	•	•	•	•	•		135	
Payer Rebilling Fee	•	•	•	•	•	•	•	135	138
Premium City Fee – Origin/Destination	•	•	•	•	•	•		135	
Redelivery	•	•	•	•	•	•	•	135	138
Residential Delivery/Pickup		•		•		•		135	
Security Surcharge	•	•	•	•	•	•	•	135	138
Truck Waiting Time	•	•	•	•	•	•	•	135	138

Within and Between the U.S., Canada and Puerto Rico

Value-Added Services

NORTH AMERICAN AIR FREIGHT

Available Options	Description	Fee
DELIVERY INSTRUCTIONS AND NOTIFICATION – PICKUP		
Special Delivery or Pickup Surcharge	<ul style="list-style-type: none"> – Applies to shipments with a delivery or pickup date of Monday through Friday that occur after the normal delivery or pickup time. Applies to locations that have a morning, afternoon or two-day guaranteed delivery time. – Advance arrangement is required for tariff points defined in the current version of the UPS Supply Chain Solutions® Quick Zip program, available on disk or via the UPS Supply Chain Solutions website at ups.com/us/en/supplychain/other/documents/quickzip.page? 	<ul style="list-style-type: none"> – Special Delivery: \$0.68 per lb., \$105.00 Minimum in U.S. and Puerto Rico; 0.68 CAD per lb., 105.00 CAD Minimum intra-Canada – Special Pickup: \$0.68 per lb., \$105.00 Minimum in U.S. and Puerto Rico; 0.68 CAD per lb., 105.00 CAD Minimum intra-Canada
Delivery or Pickup Service	<ul style="list-style-type: none"> – Applies only to airport-to-airport moves. 	<ul style="list-style-type: none"> – \$13.00 per 100 lbs. (\$45.00 Minimum between U.S., Canada and Puerto Rico) – 13.00 CAD per 100 lbs. (45.00 CAD Minimum intra-Canada)
Origin or Destination Special Handling Fee	<ul style="list-style-type: none"> – When additional, non-routine activities/services are required, selected services may be performed by UPS. – Services offered include (but are not limited to) manipulations, labeling, inventory, auditing, customized reports, spreadsheets, key entry, general order processing, etc. 	<ul style="list-style-type: none"> – \$120.00 per shipment between U.S., Canada and Puerto Rico – 115.00 CAD per shipment intra-Canada
Hold at Destination Airport for Pickup (HAPU)	<ul style="list-style-type: none"> – Freight is to be held at the carrier's destination location for pickup by the recipient. – HAPU requires a consignee name and phone number. – All services will be billed door-to-door. 	No charge
Proof of Delivery (P.O.D.)	<ul style="list-style-type: none"> – Contact your local service center to request P.O.D. To locate your local service center, call 1-800-443-6379. 	\$10.00
Saturday Delivery	<ul style="list-style-type: none"> – Saturday Delivery may be selected by the shipper where available to A.M. points only. – Shipments delivered on Saturday must be picked up on Friday. 	<ul style="list-style-type: none"> – \$35.00 per 100 lbs. – \$215.00 Minimum in U.S., Canada and Puerto Rico
Saturday Pickup	<ul style="list-style-type: none"> – Saturday Pickup may be selected by the shipper where available to A.M. points only. 	<ul style="list-style-type: none"> – \$35.00 per 100 lbs. – \$215.00 Minimum in U.S., Canada and Puerto Rico
INTERNATIONAL SHIPPING		
Canadian Import Termination Fee	<ul style="list-style-type: none"> – Fee to cover preparation of the Canadian Advise Note and Presentation of the shipment to Canadian Customs for clearance. – Applies to shipments originating in the U.S. or Puerto Rico going into Canada. 	\$70.00
Certificate of Origin	<ul style="list-style-type: none"> – Can be prepared by UPS on behalf of the shipper for exported goods manufactured and originating within the U.S. 	\$25.00
Export Declaration Fee	<ul style="list-style-type: none"> – Fee for processing the Shipper Export Declaration form that is required for all export shipments from the U.S. 	\$20.00 per shipment between U.S. and Canada
Free Domicile	<ul style="list-style-type: none"> – The shipper pays all costs of delivery, including customs clearance fees, directly to the door of the consignee. 	<ul style="list-style-type: none"> – \$45.00 per shipment between U.S., Canada and Puerto Rico – 45.00 CAD per shipment intra-Canada
Import Service Fee	<ul style="list-style-type: none"> – Applicable to every shipment imported to the U.S. 	\$55.00 per shipment between U.S. and Canada
Navigation Canada Fee	<ul style="list-style-type: none"> – Government fee that applies to all aircraft for shipments that originate or terminate in Canada. Only applicable to all UPS Next Day Air® Freight and UPS 2nd Day Air® Freight services. 	\$3.00 per 100 lbs. (\$2.25 Minimum) for shipments between U.S. and Canada in USD
U.S. Export Compliance Fee	<ul style="list-style-type: none"> – Fee assessed to U.S. export shipments for submission and preparation of export data. 	\$15.00 per standard transaction
ADDITIONAL OPTIONS		
Declared Value for Carriage	<ul style="list-style-type: none"> – UPS's liability for all losses is limited to \$50.00 per shipment or \$0.50 per pound, whichever is greater. – Shipper may declare a value in excess of these limits, subject to maximum allowable values for an additional charge. – For more information, refer to the "UPS Air Freight Terms and Conditions of Contract for UPS Air Freight Services in the United States, Canada and International" at UPS Supply Chain Solutions, ups.com/freighttermsofservice. 	<ul style="list-style-type: none"> – \$1.40 per \$100.00 – Minimum of \$130.00 between U.S., Canada and Puerto Rico
Constant Surveillance	<ul style="list-style-type: none"> – Only applicable to shipments originating in the U.S. or Puerto Rico where Constant Surveillance Service is requested. 	\$100.00 per shipment for U.S. and Puerto Rico origins; applies to CSS service only.

Notes:

- The value-added services listed are available for UPS Air Freight Services unless otherwise noted on page 131.
- Fuel surcharges apply to value-added services associated with pickup, transport and delivery. For current fuel surcharges, where applicable, visit ups.com/freightsurcharges.

Within and Between the U.S., Canada and Puerto Rico

Other Charges

NORTH AMERICAN AIR FREIGHT

Charges	Description	Fee
Address Correction	<ul style="list-style-type: none"> – If any shipment has an incorrect or incomplete address, UPS will make reasonable efforts to secure the correct or complete address and will provide the shipper with the correct address. UPS may also correct or complete an address based on information obtained from the shipper or consignee. An Address Correction charge will be assessed to the shipper for an address correction or completion. – An address validated by UPS may be incorrect or incomplete for purposes of completing delivery and may be corrected by UPS. 	\$94.00
Advancement of Charges	<ul style="list-style-type: none"> – Applicable from/to non-AM/PM points as defined in the current version of the UPS Supply Chain Solutions® Quick Zip program, available on disk or via UPS Supply Chain Solutions, ups.com/us/en/supplychain/other/documents/quickzip.page. Note: Higher charges than the standard charges listed may apply to certain limited Beyond Points (B1, B2, B3) in the United States, Alaska, Hawaii and Canada, based on the specific origin/destination. To verify applicable charges, please call 1-800-443-6379. 	<ul style="list-style-type: none"> – B1 Points: \$40.00 per 100 lbs., \$95.00 Minimum between U.S., Canada and Puerto Rico / 40.00 CAD per 100 lbs., 95.00 CAD Minimum intra-Canada – B2 Points: \$60.00 per 100 lbs., \$190.00 Minimum between U.S., Canada and Puerto Rico / 60.00 CAD per 100 lbs., 190.00 CAD Minimum intra-Canada – B3 Points: \$75.00 per 100 lbs., \$230.00 Minimum between U.S., Canada and Puerto Rico / 75.00 CAD per 100 lbs., 230.00 CAD Minimum intra-Canada
Chargeback for Consignee Billed Shipments	<ul style="list-style-type: none"> – In the event of non-payment by the consignee or third party, the original shipper will be billed a refusal fee in addition to the shipping charges. 	\$25.00
Dangerous Goods	<ul style="list-style-type: none"> – Dangerous Goods can be shipped via UPS Next Day Air® Freight NGS only. – Non-conforming freight may be subject to service delays. 	\$0.58 per lb.; \$136.00 Minimum
Fee Advance	<ul style="list-style-type: none"> – Applicable from/to non-AM/PM points as defined in the current version of UPS Supply Chain Solutions Quick Zip program, available on disk or via UPS Supply Chain Solutions ups.com/us/en/supplychain/other/documents/quickzip.page. 	<ul style="list-style-type: none"> – \$3.25 per \$100.00 charge amount (\$7.50 Minimum between U.S., Canada and Puerto Rico) – 3.25 CAD per 100.00 CAD charge amount (7.50 CAD Minimum intra-Canada)
Liftgate Services	<ul style="list-style-type: none"> – Liftgate equipment on trailers is available for customers who do not have a shipping or receiving dock and cannot load or unload their shipment without liftgate assistance. – Liftgate service must be requested, as not all trailers are equipped with liftgate devices. 	<ul style="list-style-type: none"> – Origin: \$11.50 per 100 lbs.; \$161.00 Minimum; \$451.00 Maximum – Destination: \$11.50 per 100 lbs.; \$161.00 Minimum; \$451.00 Maximum
Missing/Invalid Account Number or Refusal Fee	<ul style="list-style-type: none"> – A processing fee will be charged for a missing or invalid account number when the account number is missing, the account number is not the correct number for the bill-to party, the account number is for a receiver or third party who fails to pay the shipping charges, or the package is shipped to an unauthorized consignee. 	\$25.00
Non-Conforming Freight	<ul style="list-style-type: none"> – Shipments that are unusually shaped, non-stackable, difficult to handle or require special handling in transit (to prevent damage to the shipment, the other shipments it may come in contact with or the equipment). – Non-conforming freight may be subject to service delays and additional charges. 	30% of Air Freight charges; \$285.00 Minimum
NYC Surcharge	<ul style="list-style-type: none"> – Applies to shipments to or from New York City. 	\$200.00 per shipment

Within and Between the U.S., Canada and Puerto Rico

Other Charges

NORTH AMERICAN AIR FREIGHT

Charges	Description	Fee
Oversize	– Oversize fee will be charged to shipments that have a length + girth calculation or a single dimension exceeding the specified criteria.	Cubic Dimensional Weight and % of transportation charge for the greater of: – 20% if length + girth > 200" – 30% if a dimension = 60" – Minimum \$245.00 when a dimension > 120" between U.S., Canada and Puerto Rico – Minimum 245.00 CAD when a dimension > 120" intra-Canada
Payer Rebilling Fee	– A payer rebilling fee will be assessed for each request to change the billing instructions for a shipment.	\$25.00
Premium City Fee – Origin/Destination	– Premium cities are subject to change without prior notice. Please reference your service agreement or contact your Account Executive for applicable premium city locations. Applies outbound from or inbound to select origin or destination tariff points in the U.S. and Canada.	\$200.00 per shipment
Redelivery	– If more than one delivery attempt is made.	\$0.10 per lb.; \$85.00 Minimum
Residential Delivery/Pickup	– Fee assessed for pickup from or delivery to a home address, including a business operating out of a home that does not have an entrance open to the public.	\$190.00 per shipment between U.S., Canada and Puerto Rico; 190.00 CAD per shipment intra-Canada
Security Surcharge	– Amount to be paid in addition to basic freight charges for special care and/or special measures related to aviation security requirements.	The most current and complete version of the UPS North American Air Freight Security Surcharge schedule can be found at ups.com/us/en/supplychain/other/surcharges.page?
Truck Waiting Time	– If the driver is required to wait more than 15 minutes for either a pickup or delivery, charges based on waiting time will be computed by multiplying the hourly rate by the time involved.	– \$65.00 per hour – \$47.00 per vehicle for each 15 minutes or fraction thereof shall be made for the time consumed for the delay, subject to a minimum charge of \$83.50 – \$128.00 per vehicle for each 24-hour period or fraction thereof, excluding non-business days

Notes:

- The other charges listed are available for UPS Air Freight services unless otherwise noted on page [131](#).
- Fuel surcharges apply to other charges associated with pickup, transport and delivery. For current fuel surcharges, where applicable, visit [ups.com/freightsurcharges](https://www.ups.com/freightsurcharges) at [ups.com/supplychainsolutions](https://www.ups.com/supplychainsolutions).

Freight Between the U.S. and Mexico

Value-Added Services

UPS WORLDWIDE EXPEDITED® GROUND FREIGHT

Available Options	Description	Fee
Certificate of Origin	– Can be prepared by UPS on behalf of the shipper for exported goods manufactured and originating within the U.S.	\$25.00
Declared Value for Carriage	– UPS's liability for all losses is limited to \$50.00 per shipment or \$0.50 per pound, whichever is greater. – Shipper may declare a value in excess of these limits, subject to maximum allowable values for an additional charge. – For more information, refer to the "UPS Air Freight Terms and Conditions of Contract for UPS Air Freight Services in the United States, Canada and International" at UPS Supply Chain Solutions at ups.com/freighttermsofservice .	– \$1.40 per \$100.00 – Minimum of \$130.00
Hold at Destination Airport for Pickup (HAPU)	– Freight is to be held at the carrier's destination location for pickup by the recipient. – HAPU requires a consignee name and phone number. – All services will be billed door-to-door.	No charge
Import Service Fee	– Applicable to every shipment imported to the U.S.	\$55.00
Proof of Delivery (P.O.D.)	– Contact your local service center to request P.O.D. To locate your local service center call 1-800-443-6379.	\$10.00
U.S. Export Compliance Fee	– Fee assessed to U.S. export shipments for submission and preparation of export data.	\$25.00

Notes:

- Fuel surcharges apply to value-added services associated with pickup, transport and delivery. For current fuel surcharges, where applicable, visit ups.com/freightsurcharges at ups.com/supplychainsolutions.
- The value-added services listed are available for UPS Worldwide Expedited Ground Freight services unless otherwise noted on page 131.
- UPS Worldwide Expedited Ground Freight is governed by the "UPS Air Freight Terms of Contract for UPS Air Freight Services in the United States, Canada and International" at UPS Supply Chain Solutions ups.com/freighttermsofservice.

Freight Between the U.S. and Mexico

Other Charges

UPS WORLDWIDE EXPEDITED® GROUND FREIGHT

Charges	Description	Fee																								
Address Correction	<ul style="list-style-type: none"> – If any shipment has an incorrect or incomplete address, UPS will make reasonable efforts to secure the correct or complete address and will provide the shipper with the correct address. UPS may also correct or complete an address based on information obtained from the shipper or consignee. An Address Correction charge will be assessed to the shipper for an address correction or completion. – An address validated by UPS may be incorrect or incomplete for purposes of completing delivery, and may be corrected by UPS. 	\$94.00																								
Advancement of Charges	<ul style="list-style-type: none"> – Applicable from/to non-AM/PM points as defined in the current version of UPS Supply Chain Solutions® Quick Zip program, available on disk or via the UPS Supply Chain Solutions at ups.com/us/en/supplychain/other/documents/quickzip.page. 	<table border="1"> <thead> <tr> <th>Beyond Point Charges per Lb.</th> <th>B1</th> <th>B2</th> <th>B3</th> </tr> </thead> <tbody> <tr> <td>551-1101 lbs.</td> <td>\$0.22</td> <td>\$0.26</td> <td>\$0.36</td> </tr> <tr> <td>1102-2204 lbs.</td> <td>\$0.18</td> <td>\$0.24</td> <td>\$0.33</td> </tr> <tr> <td>2205-4407 lbs.</td> <td>\$0.16</td> <td>\$0.21</td> <td>\$0.30</td> </tr> <tr> <td>4408 lbs. and Up</td> <td>\$0.13</td> <td>\$0.19</td> <td>\$0.28</td> </tr> <tr> <td>Minimum Charge</td> <td>\$94.00</td> <td>\$147.00</td> <td>\$197.00</td> </tr> </tbody> </table>	Beyond Point Charges per Lb.	B1	B2	B3	551-1101 lbs.	\$0.22	\$0.26	\$0.36	1102-2204 lbs.	\$0.18	\$0.24	\$0.33	2205-4407 lbs.	\$0.16	\$0.21	\$0.30	4408 lbs. and Up	\$0.13	\$0.19	\$0.28	Minimum Charge	\$94.00	\$147.00	\$197.00
Beyond Point Charges per Lb.	B1	B2	B3																							
551-1101 lbs.	\$0.22	\$0.26	\$0.36																							
1102-2204 lbs.	\$0.18	\$0.24	\$0.33																							
2205-4407 lbs.	\$0.16	\$0.21	\$0.30																							
4408 lbs. and Up	\$0.13	\$0.19	\$0.28																							
Minimum Charge	\$94.00	\$147.00	\$197.00																							
Chargeback for Consignee Billed Shipments	<ul style="list-style-type: none"> – In the event of non-payment by the consignee or third party, the original shipper will be billed a refusal fee in addition to the shipping charges. 	\$25.00																								
Detention of Vehicle	<ul style="list-style-type: none"> – Detention of Vehicle fees apply (with power and without power) upon expiration of the applicable free time allowed. 	\$65.00																								
Liftgate Services																										
Origin	<ul style="list-style-type: none"> – Fee assessed for pickup that requires a vehicle equipped with a mechanical lifting device. 	<ul style="list-style-type: none"> – \$11.50 per 100 lbs. – \$161.00 Minimum – \$451.00 Maximum 																								
Destination	<ul style="list-style-type: none"> – Fee assessed for delivery that requires a vehicle equipped with a mechanical lifting device. 	<ul style="list-style-type: none"> – \$11.50 per 100 lbs. – \$161.00 Minimum – \$451.00 Maximum 																								
Missing/Invalid Account Number or Refusal Fee	<ul style="list-style-type: none"> – A processing fee will be charged for a missing or invalid account number when the account number is missing, the account number is not the correct number for the bill-to party, the account number is for a receiver or third party who fails to pay the shipping charges, or the package is shipped to an unauthorized consignee. 	\$25.00																								
Non-Conforming Freight	<ul style="list-style-type: none"> – Shipments that are unusually shaped, non-stackable, difficult to handle or require special handling in transit (to prevent damage to the shipment, the other shipments it may come in contact with or the equipment). – Non-conforming freight may be subject to service delays and additional charges. 	30% of Air Freight charges \$285.00 Minimum																								

Freight Between the U.S. and Mexico

Other Charges

UPS WORLDWIDE EXPEDITED® GROUND FREIGHT

Charges	Description	Fee
Payer Rebilling Fee	– A payer rebilling fee will be assessed for each request to change the billing instructions for a shipment.	\$25.00
Redelivery	– If more than one delivery attempt is made.	\$0.10 per lb.; \$85.00 Minimum
Security Surcharge	– Amount to be paid in addition to basic freight charges for special care and/or special measures related to transportation security requirements. The most current and complete version of the UPS North American Air Freight security surcharge schedule can be found at ups.com/us/en/supplychain/other/surcharges.page?	\$0.03 per lb.
Truck Waiting Time	– If the driver is required to wait more than 15 minutes for either a pickup or delivery, charges based on waiting time will be computed by multiplying the hourly rate by the time involved.	<ul style="list-style-type: none"> – \$65.00 per hour – \$47.00 per vehicle for each 15 minutes or fraction thereof shall be made for the time consumed for the delay, subject to a minimum charge of \$83.50 – \$128.00 per vehicle for each 24-hour period or fraction thereof, excluding non-business days

Notes:

- Fuel surcharges apply to other charges associated with pickup, transport and delivery. For current fuel surcharges, where applicable, visit ups.com/freightsurcharges at ups.com/supplychainsolutions.
- The other charges listed are available for UPS Worldwide Expedited Ground Freight services unless otherwise noted on page 131.
- UPS Worldwide Expedited Ground Freight is governed by the “UPS Air Freight Terms of Contract for UPS Air Freight Services in the United States, Canada and International” at UPS Supply Chain Solutions ups.com/freighttermsofservice.

Customs Brokerage

PACKAGE

The following applies per shipment for imports into the U.S.:

- All UPS Worldwide Express Plus[®], UPS Worldwide Express NA1[®], UPS Worldwide Express[®], UPS Worldwide Express Freight[®] Midday, UPS Worldwide Express Freight[®], UPS Worldwide Saver[®], UPS Worldwide Expedited[®], UPS 3 Day Select[®] from Canada and UPS[®] Standard to/from Mexico rates include routine customs clearance. Routine customs clearance is built into your rates when you use UPS to perform the customs clearance for any of these services.
- Additional services such as parts database management, customer-specific classification directives, special operating plans, assigned rating team, custom reporting and other value-added services are part of our Customized

Brokerage Services and subject to a customs entry fee and/or other charges. Please see Customized Brokerage Services on page [140](#) for more information.

- UPS also provides services designed to facilitate movements of your UPS Standard shipments to and from Canada (see brokerage rates into Canada at ups.com/rates/ca) and other non-routine services that include formal entry clearance, live entry clearance, temporary import bonds, and duty drawbacks. In addition, UPS can provide customs clearance for other ocean, air freight, truck and rail U.S. imports. The importer is responsible for all brokerage fees, including duties and taxes. See charts on the following pages for more information.
- The UPS Service Guarantee does not apply when customs clearance is performed by brokerage offices other

than those designated by UPS, or if a service delay is the result of certain events beyond our control, such as a government agency hold.

- Customs clearance for services specified here is provided by the UPS Supply Chain Solutions[®] customs brokerage offices designated by UPS for handling package customs clearance. Other UPS Supply Chain Solutions customs brokerage offices charge fees for clearance of packages and freight. Customs clearance and brokerage services are subject to the Customs Brokerage and Freight Forwarding Terms and Conditions/U.S. located at UPS Supply Chain Solutions ups.com/freighttermsofservice.

For more information on any of our Customs Brokerage Services, call 1-800-782-7892.

UPS Broker of Choice[®]

With UPS Broker of Choice service, importers select their own alternate customs broker for customs clearance of their UPS international shipments. This service is available for all UPS international shipments, except for UPS Standard service.

This contractual, fee-based service allows the importer to utilize UPS for international shipping needs, with an alternate broker providing customs clearance. The importer may use UPS Broker of Choice service for specific

commodities or product lines, while continuing to utilize UPS brokerage expertise for others.

UPS technology makes shipment information and documentation (e.g., the commercial invoice) available to the designated broker at the time of export. This enables customs clearance in a timely manner.

Importers have two options:

1. UPS Broker of Choice OnSite keeps shipments in UPS's possession while the

importer's customs broker completes customs clearance procedures prior to UPS completing delivery of the shipment.

2. UPS Broker of Choice OffSite moves shipments in-bond directly to a customs-controlled (bonded) warehouse (at the importer's direction), where the importer's customs broker completes the customs clearance procedures. The UPS transport is completed upon delivery of the shipment to the warehouse. Refer to page [140](#) for fees.

Note: For information on UPS Customs Brokerage Services for your freight needs, including the Customs Brokerage and Freight Forwarding Terms and Conditions, please visit ups.com/supplychainsolutions.

Customs Brokerage

PACKAGE

UPS® FTZ Facilitator

With UPS FTZ Facilitator service, importers and exporters have the ability to use UPS to transport international shipments in-bond to and from a global Free/Foreign Trade Zone (FTZ). This service is available for all UPS international shipments, except for UPS® Standard service.

This contractual, fee-based service allows the shipment of goods to and from an FTZ, while retaining the benefits of UPS's transportation network. Using UPS as a single source enables

importers and exporters to increase visibility and tracking, and reduce the chance for errors and costs associated with utilizing multiple transportation providers.

UPS technology enables shipment information and documentation (e.g., the commercial invoice) available to the customer, customer's broker and FTZ operator at the time of export. This enables prompt processing of the FTZ entry.

Importers will choose UPS FTZ Facilitator import service to direct shipments to be delivered in-bond to a designated FTZ rather than being cleared through customs.

Exporters will choose UPS FTZ Facilitator export service to ship goods in-bond from an FTZ to an international destination. Refer to page [142](#) for fees.

Entry Preparation Charges for Importing into the United States

All rates and values are shown in U.S. funds. Rates are per shipment and do not include applicable taxes.

Value for Duty	UPS Worldwide Express Plus® UPS Worldwide Express NA1® UPS Worldwide Express® UPS Worldwide Express Freight® Midday UPS Worldwide Express Freight® UPS Worldwide Saver® UPS Worldwide Expedited® UPS 3 Day Select® from Canada UPS® Standard from Mexico	UPS® Standard from Canada*
\$0.00 to \$800.00**	No Charge***	No Charge††
\$800.01† to \$1,250.00	No Charge***	\$28.75
\$1,250.01 to \$2,500.00	No Charge***	\$40.50
Each Additional \$1,000.00 or Part Thereof	No Charge***	\$1.95

*When UPS Supply Chain Solutions is designated as the customs broker on the commercial invoice for the product listed above, the UPS Service Guarantee applies to your shipment, subject to its terms set forth in the applicable "UPS Tariff/Terms and Conditions of Service – United States" available at [ups.com/termsandservice](https://www.ups.com/termsandservice). The UPS Service Guarantee does not apply when customs clearance is performed by customs brokerage offices other than those designated by UPS for clearing the products listed above. Call 1-800-782-7892 for more information.

**\$800.00 or current de minimis requirements set forth by law, if different.

***For UPS Worldwide Express Plus, UPS Worldwide Express NA1, UPS Worldwide Express, UPS Worldwide Express Freight Midday, UPS Worldwide Express Freight, UPS Worldwide Saver, UPS Worldwide Expedited, UPS 3 Day Select from Canada and UPS Standard from Mexico service levels, routine customs clearance (for entries up to three entry lines) is included at no additional cost. Additional charges will apply if customs clearance is performed by customs brokerage offices other than those designated by UPS for clearing the products listed above.

† \$800.01 or \$0.01 higher than current de minimis requirement set forth by law, if different.

†† An Entry Preparation Charge will apply on any UPS Standard from Canada shipment below de minimis value requiring an entry, at the fee amount published for goods valued between \$800.01 and \$1,250.00.

Customs Brokerage

PACKAGE

The Customs Brokerage information below applies to all UPS international package and UPS Worldwide Express Freight® services, unless otherwise noted.

Service	Explanation	Fee
BONDS (CONTRACT ONLY)		
Continuous Transaction Bond	– One-year import bond for all entries made in a single year with up to \$50,000.00 coverage. – Required under special circumstances.	\$535.00
In-Transit Bond (IT Bond)	– Allows a shipment to be transported under U.S. Customs and Border Protection supervision until it is formally entered into the customs territory of the U.S. and duty is paid, or until it is exported from the U.S.	\$85.00
Single Entry Bond (SEB)	– One-time import bond issued to ensure compliance with U.S. laws and regulations. – When an SEB is necessary, UPS will contact the importer prior to customs clearance.	\$5.00 per \$1,000.00 (Minimum \$50.00)
SPECIAL ENTRIES		
Additional Consignee or Invoice	– A fee applies if the shipment has more than one consignee or one commercial invoice.	\$2.10 for each additional consignee and invoice
Complex Entries	– Usually requires a formal entry and may require an additional day of customs clearance. – A Complex Entry fee will be applied to the following: <ul style="list-style-type: none"> • A live entry that is required by U.S. Customs and Border Protection (CBP) when an export license (visa) is mandated for import into the U.S. • If the commodity and country of origin require Antidumping/Countervailing Duties. Antidumping/Countervailing Duty entries help U.S. companies compete with foreign industries and require additional information for U.S. Customs and Border Protection. • Any imported goods, goods returned and goods previously imported that require additional U.S. Customs and Border Protection documentation to substantiate the duty-free claim. • Goods with additional licensing requirements. • When the customer requests UPS to file a single entry for a non-restricted commodity which normally qualifies for clearance under a consolidated manifest (Title 19 CFR 128.24[e]). 	\$25.00
Duty Drawbacks	– The preparation of a refund request for part or all of customs duty or domestic tax paid on imported merchandise that was subsequently manufactured into a different article or re-exported. Service is offered via UPS Trade Advisory Services.	Available upon request
Entry-Line Charge After First Three Lines	– A fee applies when more than three entry lines are entered. – UPS is not responsible for consolidating entry lines for customs clearance, including lines that have the same Harmonized Tariff Code and Country of Origin.	\$3.00/line
Entry Type 86 Processing	– A fee applies when the customer requests UPS to file a single entry under Entry Type 86 for a shipment which normally qualifies for clearance under a consolidated manifest (Title 19 CFR 128.24[e]).	\$11.00
Fish and Wildlife (F&W) Entry Preparation	– Fish and Wildlife Service is a government agency that requires the filing of certain documents and permits and conducts inspections of products that contain wildlife or plant species that fall under the F&W jurisdiction. A fee of \$25.00 will be assessed for UPS preparing and transmitting the Fish and Wildlife USFWS Form 3-177.	\$25.00 for first transmission per agency per shipment, plus \$5.00 for each additional transmission*
Foreign Trade Zone (FTZ) Entry	– These types of entries are non-routine and must be requested by the importer to UPS Supply Chain Solutions. For more information, refer to UPS® FTZ Facilitator service on pages 140 and 142 .	Upon request

*All fees charged by any government agency or other third party, if any, will be billed in addition to the listed fees.

Customs Brokerage

PACKAGE

The Customs Brokerage information below applies to all UPS international package and UPS Worldwide Express Freight® services, unless otherwise noted.

Service	Explanation	Fee
SPECIAL ENTRIES (CONTINUED)		
Partner Government Agency (PGA) Clearance	<ul style="list-style-type: none"> Government agencies work with U.S. Customs and Border Protection on regulating and controlling commodities coming into the U.S. from other countries. Special documents must be transmitted to these agencies for shipments that contain controlled Commodities. Agencies include the Food and Drug Administration (FDA), Department of Agriculture (USDA) and the Federal Communications Commission (FCC), among others. 	– \$25.00 for first transmission per agency per shipment, plus \$5.00 for each additional transmission*
PGA Disclaimer Fee	– Assessed when UPS has to review and substantiate that a commodity is not subject to regulation of a Partner Government Agency (PGA).	\$1.00 per disclaimer
Prior Notice for Food and Food Products	– A fee applies if you want UPS to provide Prior Notice to the U.S. Food and Drug Administration (FDA) for food and food products imported into or moving through the U.S. This advance notice is required by the Bioterrorism Preparedness and Response Act of 2002. For import shipments, the Prior Notice fee is in addition to the existing FDA Clearance fee for regulated food and food products.	\$12.00
Temporary Import Under Bond	– Special customs entry for merchandise to be brought into the country exempt of duty, provided the merchandise exits the country within a certain amount of time and under U.S. Customs and Border Protection supervision.	\$95.00
UPS Broker of Choice®	– Enables an importer to use an alternate customs broker for imported shipments, providing advanced visibility of shipment documents to the selected alternate broker, clearance while in UPS's possession (OnSite), with UPS completing delivery or after UPS has delivered to a designated bonded warehouse (OffSite).	\$55.00 (OnSite)/\$55.00 (OffSite); OffSite will also include a separate In-Transit Bond fee
UPS® FTZ Facilitator	– Facilitates the bonded movement from the first port of arrival to the FTZ location, providing advanced visibility of shipment documents to the importer or FTZ operator; also available for international shipments originating in FTZ.	\$85.00
Warehouse Entry	<ul style="list-style-type: none"> Fee assessed to the customer when a request is made by the importer to file a warehouse entry. These types of entries are non-routine and must be requested by the importer to UPS Supply Chain Solutions® 	\$132.50
OTHER SERVICES		
Customized Brokerage Services	<ul style="list-style-type: none"> UPS can provide additional customized brokerage services to meet your specific importing and compliance needs. Examples of these contractual, fee-based services include customized reports, shipment pre-alerts, classification confirmations and others. The fees for these customized services depend on the types of services requested. 	Upon request
Customs Entry Packets	<ul style="list-style-type: none"> Entry and payment documentation for shipments that have been through the U.S. Customs and Border Protection payment and review process. Request by the shipper, consignee and/or third party for import clearance documentation which could include, but is not limited to, records previously supplied to the broker by the shipper/consignee or copies of any import clearance documentation. 	\$2.00 per packet or shipment
Disbursement Fee	<ul style="list-style-type: none"> Customers are responsible for payment of duty and taxes. Fee of 2% (Minimum \$13.00) of the amount paid or processed by UPS on behalf of the customer will be charged. 	2% of Duty/Tax (Minimum \$13.00)
Duty	– Fee imposed by U.S. Customs and Border Protection on imported merchandise.	Based on the value and/or gross weight; it differs according to the commodity

*All fees charged by any government agency or other third party, if any, will be billed in addition to the listed fees.

Customs Brokerage

PACKAGE

The Customs Brokerage information below applies to all UPS international package and UPS Worldwide Express Freight® services, unless otherwise noted.

Service	Explanation	Fee
OTHER SERVICES (CONTINUED)		
Formal Entry	– Required for shipments valued at more than \$2,500.00 (U.S.) or for shipments containing specific commodities designated by U.S. Customs and Border Protection.	See Complex Entries on page 141
Marking Notice Processing	– Special documents must be filed for a shipment not properly marked with the country of origin. – Customs Power of Attorney must also be completed and on file with brokerage before the shipment can be forwarded to the consignee for proper marking.	\$80.00
Merchandise Processing Fee	– A non-refundable fee charged by U.S. Customs and Border Protection for administrative expenses for processing certain imported shipments. The fee will not apply if the goods qualify under applicable free trade agreements. For Air shipments: – Applicable only for formal entries (customs value more than \$2,500.49 or as required by regulation). For Ground shipments: – Applicable for both informal and formal entries.	Based on the value of merchandise; minimum and maximum fees may apply
Overtime/Special Handling Service (Hourly Rate)	– When additional, non-routine activities/services are required, selected services may be performed by UPS. – Services offered include (but are not limited to) manipulations, labeling, inventory, auditing, customized reports, spreadsheets, key entry, general order processing, etc. – UPS reserves the right to charge in one-hour increments, rounded up to the next hour. – Please contact a brokerage specialist if there is a need for additional clearance services.	\$53.00 per hour*
Post Entry Services	– Protest: Request from an importer to recoup the overpayment of duty to U.S. Customs and Border Protection due to a description discrepancy or misclassification on the customs entry. – Post Summary Correction: Request from an importer to obtain corrections to an entry filed with U.S. Customs and Border Protection prior to liquidation. – Voluntary Tender: Request from an importer to submit additional duties owed to U.S. Customs and Border Protection, where submission is initiated by the customer.	\$95.00 / \$120.00**
Pre-Release Notification	– This fee applies when customer contact is required prior to releasing the shipment.	\$14.00 per shipment
Transportation Handling	– Assessed when shipments are removed from the UPS system, at the request of the importer, to be forwarded to another broker for clearance. – Shipments are transferred from the UPS-bonded facility to the designated bonded agent's facility. – A bonded carrier or cartman must be used to transfer goods in-bond from UPS to another carrier based on approval to move the goods from U.S. Customs and Border Protection. – Transfer may be denied by UPS Supply Chain Solutions® Customs Brokerage Services.	\$30.00
United States-Mexico-Canada Agreement (USMCA) Processing	– Special processing to ensure that the required USMCA documentation on a shipment is complete to allow any applicable reduced tariff.	\$21.25
Warehouse Storage – Air/Ground – Per Day After Two Days	– Assessed when shipments remain in the UPS warehouse after the two free days regardless of the customs broker.	\$25 Minimum + \$0.05 per lb. per day after two days; \$0.10 per lb. per day after 7 days

*All fees charged by any government agency or other third party, if any, will be billed in addition to the listed fees.

**Complex post entry services include, but are not limited to, protests and complex post summary corrections (i.e., tariff exclusions and multiple tariff lines).

How to Use This Guide

Section 1 CHOOSING A SERVICE PAGES [3-9](#)

Section 2 PREPARING A SHIPMENT PAGES [10-26](#)

Section 3 DETERMINING THE RATE PAGES [27-143](#)

Section 4

TRACKING AND PAYMENT

Convenient and up-to-the-minute ways to track shipments are reviewed, as well as an explanation of the UPS invoice, its presentation and various billing and payment options.

- Track your shipment as it moves through the UPS system from drop-off or pickup to completed delivery. Pages [145-146](#)
 - Choose to review your invoice in a variety of electronic formats or as a paper summary. Page [147](#)
 - Select from a number of payment plans that offer weekly and monthly options. Page [148](#)
 - Review solutions for managing your invoice and tips on how to avoid additional charges. Page [149](#)
-

Track Your Shipment

Convenient Ways to Track Shipments

Method	Description
UPS® Mobile App*	– Track your package shipments anytime and anywhere directly from your mobile device. Visit ups.com/mobile to learn more or to download the app.
Coyote® coyote.com	Provides direct access for customers to create, view, track and settle their own loads, and for carriers to find, accept and update loads. – Network map includes filters to provide a focused, filtered view and ability to hover over lane to see lane information. – Customizable load board allows users to add or remove columns to view the most valuable information. – Streamlined accounting features allow for uploading paperwork, viewing invoices and checking accounting status. – CoyoteGO® for Carriers is a free digital freight platform available online or via mobile app. Through its easy-to-use interface, carriers can access Coyote Logistics' digital load board of over 10,000 daily shipments to browse freight opportunities, negotiate rates, book loads, access tracking options, submit invoices and get paid – all in one platform. – CoyoteGO® for Shippers is a free digital freight platform that can be accessed on both desktop and mobile devices. Its intuitive interface makes it simple to build shipments, get spot quotes with real-time market rates from Coyote Logistics' network of 100,000+ carriers, print documents, view and pay invoices, and track freight. – CoyoteGO® Premium is a free, cloud-based TMS (Transportation Management System) platform that gives shippers total control over their freight networks. Shippers can tender freight, manage routing guides, get real-time spot quotes, book truckload and LTL shipments from Coyote Logistics' brokerage, track freight, and generate custom KPI reports. – Call 1-877-626-9683 or coyote.com/technology for more information.
Flex® Global View	– Query status and receive email alerts on Air Freight, Ocean Freight and UPS Worldwide Expedited® Ground Freight shipment exceptions, warehouse inventory and backorders, purchase orders and fulfillment, as well as customs brokerage entries and clearance. – Search by multiple customer reference types, trade lanes, purchase orders, waybills, bills of lading and ocean containers; receive standard and customized reports in PDF, Excel or text formats. – Contact your UPS representative or visit ups.com for more information on Flex Global View .
UPS InfoNotice® Number	– Number assigned by UPS that links all shipments for a delivery attempt together (patent pending). For detailed information on each shipment, go to ups.com or call 1-800-833-9943.
UPS My Choice®**	– Provides recipients with proactive delivery alerts via text,** email or UPS Mobile App push notification the day before delivery and the morning of delivery. Confirmation of delivery and delivery schedule updates are available.
UPS My Choice® for Business	– A web-based tool designed to give commercial and home-based businesses better control and visibility into their shipments, allowing them to easily manage their UPS services from a customizable dashboard: <ul style="list-style-type: none"> • At-a-glance view of all inbound, outbound and third-party shipments with interactive dashboards to easily track shipments. • View estimated delivery windows*** to prepare incoming shipments. • Filter by date, shipment characteristics or accounts with updates from label creation to delivery. • View current shipment status to provide more accurate timing to customers and help resolve any issues. • Set notifications preferences to get automatic status alerts, including for the day before and day of delivery. • Enable additional users within your organization to access important visibility information. • Learn more and enroll any time at ups.com/mychoiceforbusiness.
Quantum View® Data*	– A tracking data subscription service that provides package status updates via data files hourly (or as often as requested), when new information is available, about UPS shipments you ship/receive and shipments billed to your UPS account. Files are available in CSV, Flat File (TXT), XML and EDI formats for integration into your software applications and databases. – Contact your UPS representative or visit ups.com/quantumview for more information.
Quantum View Manage®	– Allows you to receive proactive package shipment status information via a user-friendly web interface without having to provide a tracking number. View information about UPS shipments you ship, receive or bill to your UPS account. – Create custom views of shipping information, filter information and results, search by criteria you choose, set alerts, email interested parties with shipping information and download data. – For importers: provides additional inbound solutions to expedite clearance delays, automate customs compliance processes, audit post-clearance shipments prior to the payment of duties, contact UPS Customs Brokerage representatives and archive trade documents. – Contact your UPS representative or visit ups.com/quantumview for more information.
Quantum View Notify®	– Sends proactive Ship, Exception and Delivery notifications of key package shipment events to as many as five email addresses per request or two SMS (text) recipients when requested in ups.com tracking or UPS My Choice for Business. – Choose any combination of three critical shipment notifications for a particular shipment: when shipping information is received by UPS, when the shipment is delivered and when there is an exception which results in a change in the scheduled day of delivery. – Can be requested at the time a shipment is processed in WorldShip® or UPS CampusShip® shipping systems, the UPS App, the UPS® Developer Kit, ups.com shipping and a UPS Ready® solution approved to use this service. – Can also be selected post-shipment at Tracking on ups.com and Quantum View Manage tracking. – Contact your UPS representative or visit ups.com/quantumview for more information. – If UPS carbon neutral is also selected, email notifications will be on a UPS carbon neutral branded template highlighting that the shipment is carbon neutral.

*Not available for UPS Worldwide Express Freight® Services.

**Your carrier's standard message and data rates may apply.

***Delivery windows are based on varying scheduled delivery patterns and do not constitute a guarantee that packages will always be delivered as scheduled. Refer to the "UPS Tariff/Terms and Conditions of Service – United States" available at ups.com/termsofservice.

Track Your Shipment

Convenient Ways to Track Shipments (continued)

Method	Description
Reference Number	– Number you can assign when you ship to help you identify your shipment. Reference number can contain any combination of letters and numbers up to 35 characters.
Text Message	– Track your package shipment via text messaging.
Tracking Number	– Number automatically assigned to your shipment by UPS to identify and locate the shipment as it travels through the UPS system.
ups.com	– Track your package and UPS Supply Chain Solutions shipments directly from the ups.com homepage, or click on the Tracking menu to track up to 25 different tracking or UPS InfoNotice® numbers. Logged-in users can also track by using your own reference numbers. UPS My Choice® or UPS My Choice® for Business users logged into ups.com will have full Shipment Detail visibility for their packages.
Within Your Business	– Integrate the Tracking Application Programming Interface (API), one of the UPS Developer Kit APIs, into your business applications or onto your website; use a tracking or reference number to track your package and freight shipments.

PACKAGE

Proof of Delivery (P.O.D.)

Service	Description
Proof of Delivery (P.O.D.)	– Proof of Delivery of a shipment via email, fax or mail is subject to a charge which will be assessed to the shipper. Refer to page 121 for charges and details.
Signature Tracking®	– Web-based enhanced shipment tracking for instant access to Proof of Delivery information, including a digital signature image and full delivery address. – Available at no charge. – Sign up at ups.com/myups/login . Once logged in, select Tracking from the Services menu and then choose Signature Tracking from the menu of services on the right side of the page.

Manage Your Claims

Now you can efficiently and conveniently manage your package claims online. From this website you can:

- Report a problem
- Provide claim documentation
- Check the status of a claim
- Receive key status updates via email
- View and download claim history
- Initiate a claim dispute
- Access information about minimizing specific packaging problems that can result in lost or damaged packages
- Contact UPS with questions

You can access the claim site by:

- Visiting [Claims Support](#)
- Going to the Customer Service section under the Support tab on ups.com

Plus, the ability to manage your claims has been integrated into systems you already use:

- Tracking on ups.com: If there is a problem with your package, you will see a link under “File a Claim” on the detailed tracking result page. This link will allow you to report a lost or damaged package or missing C.O.D.

- Quantum View Manage® tracking: If you are a subscriber, you will see a link on the Shipment Progress page to “report a lost or damaged package.”
- UPS My Choice® for Business: From the dashboard Claims module, you can initiate a claim by selecting “New Claim.”

For UPS Worldwide Express Freight® Middy and UPS Worldwide Express Freight® claims, call 1-800-782-7892.

Reviewing Your Invoice

Viewing, Downloading, Paying and Managing Your Invoice

UPS offers a number of options for viewing, downloading, paying and managing your invoice. You may want to consider one of our information-rich electronic invoice formats, designed to help your company allocate and reconcile UPS charges more effectively. To learn more or enroll in these options, visit ups.com/billing.

Solutions	Description	Benefits
UPS Billing Center	<ul style="list-style-type: none"> – A secure, easy-to-use website that allows you to view, pay and request adjustments to your invoice online. – Provides invoices electronically through online reporting, customized reports or downloading a file of your invoice similar to UPS Billing Data in PDF, CSV or XML formats. – To learn more, visit ups.com/billing. 	<ul style="list-style-type: none"> – An electronic alternative to receiving paper bills for package services, including Brokerage and UPS Mail Innovations® service. – Receive invoices faster. – Set up/arrange to have payments sent electronically, eliminating the printing and mailing of checks. – Access to supporting brokerage documents (e.g., Commercial Invoice) for U.S. import shipments. – Create/download summary or detailed reports to improve cost allocation for package shipments.* – Print as much or as little of the invoice as needed. – Electronic filing of invoices saves time and space.
UPS Billing Data	<ul style="list-style-type: none"> – UPS Billing Data is a detailed electronic billing file that can be received in a CSV, XML or EDI 210 format. – To learn more, visit ups.com/billing. 	<ul style="list-style-type: none"> – An electronic alternative to receiving paper bills for package services. – Receive invoices faster. – Allows the integration of UPS billing information into accounting and other business applications. – Facilitates faster and easier invoice reconciliation, cost allocation and accounts payable processes.
UPS PDF Invoice	<ul style="list-style-type: none"> – The electronic document is an exact copy of your paper bill and is available for domestic, export and import bills. – When your bill is ready, UPS will send you an email that directs you to ups.com to receive your invoice. 	<ul style="list-style-type: none"> – Able to view up to 52 weeks of PDF invoices. – Easy record-keeping and allows you to view your statements faster.
UPS Paper Bill	<ul style="list-style-type: none"> – Receive a summary or detailed paper bill sent via the U.S. Mail. 	<ul style="list-style-type: none"> – Does not require a computer to review shipping charges.
Coyote® coyote.com	<ul style="list-style-type: none"> – Provides direct access for customers to create, view, track and settle their own loads, and for carriers to find, accept and update loads. – Call 1-877-626-9683 or visit coyote.com/technology for more information. 	<ul style="list-style-type: none"> – Network map includes filters to provide a focused, filtered view and ability to hover over lane to see lane information. – Customizable load board allows users to add or remove columns to view the most valuable information. – Streamlined accounting features allow for uploading paperwork, viewing invoices and checking accounting status. – Simplified tracking allows you to flag and track high-priority shipments, export entire load activity for easy viewing, and mark specific commodities to quickly view all related shipments.

*Not available for Air Freight, Ocean Freight or UPS Worldwide Expedited® Ground Freight.

Reviewing Your Invoice

PACKAGE

UPS Billing and Payment Schedules

Schedules	Description
Billed Weekly/Pay Weekly	<ul style="list-style-type: none"> – Receive an invoice weekly and pay weekly. – Payment is due within the terms stated on the invoice. – A late payment fee will be assessed on balances that are past due. – Payment can be made by Electronic Funds Transfer, credit card or check. – Electronic Payment options are available via the UPS Billing Center.
Billed Weekly/Pay Monthly	<ul style="list-style-type: none"> – Receive an invoice weekly but pay only once a month. – A prepayment equal to four weeks' average shipping charges must be made and will remain on account with UPS. – Payment is due within the terms stated on the invoice. – A late payment fee will be assessed on balances that are past due. – Payment can be made by Electronic Funds Transfer or check. – Electronic Payment options are available via the UPS Billing Center.
Billed Monthly/Pay Monthly*	<ul style="list-style-type: none"> – Receive an invoice monthly and pay monthly. – A prepayment equal to four weeks' average shipping charges must be made and will remain on account with UPS. – To avoid a prepayment, a Credit Extension Fee can be charged based on your annual shipping charges and is subject to change annually. – Establishing an Electronic Funds Transfer payment option allows you to avoid a prepayment and the Credit Extension Fee. – Payment is due within the terms stated on the invoice. – A late payment fee will be assessed on balances that are past due. – Payment can be made by Electronic Funds Transfer or check. – Electronic Payment options are available via the UPS Billing Center.

**Monthly billing is limited to customers with average shipping charges of \$200.00 or less per week. To be eligible for the Credit Extension Plan, you must use UPS transportation services solely for business, commercial or agricultural purposes. The first-year fee is \$45.00. The fee for each following year will be based on yearly revenue. If the yearly revenue is under \$15,600.00, the fee will be \$45.00. If the yearly revenue exceeds \$15,600.00, the fee will be the actual yearly revenue multiplied by .0163.*

Notes:

- UPS reserves the right to approve billing and payment schedules and payment methods requested.
- The “UPS Tariff/Terms and Conditions of Service – United States” available at ups.com/termsofservice contains provisions for a late payment fee on past-due balances (including, without limitation, any previously assessed, but unpaid, late payment fees).
- The shipper should check with its bank to ensure that there are no fees for electronic transactions.

Reviewing Your Invoice

Solutions for Managing Your Invoice

UPS offers a variety of options to help you manage your shipping costs by allowing you to determine who pays what portion of the shipping charges.

UPS Billing/Payer Options

Options	Description
PACKAGE, AIR FREIGHT AND UPS WORLDWIDE EXPEDITED® GROUND FREIGHT	
Bill Shipper (Prepaid)	– Shipper's UPS account is billed for shipping charges.
Bill Receiver (Freight Collect)	– Receiver's UPS account is billed for shipping charges.
Bill Third Party	– A third party's UPS account is billed for shipping charges.
INTERNATIONAL PACKAGE	
Free Domicile	– The shipper pays all costs of delivery, including customs clearance fees, directly to the door of the consignee.
Split Duty and Tax	– Shipper's UPS account is billed for shipping charges and duties. – Receiver's UPS account is billed for all taxes.
AIR FREIGHT AND UPS WORLDWIDE EXPEDITED GROUND FREIGHT	
Shipper's Check Received	
– Delivery Duties Paid (DDP)*	Fees vary by country and seller's charges.
– Delivery Duties Unpaid (DDU)*	Importer is responsible for fees that vary by country.

**For a quoted price, the seller/exporter clears the goods for export and is responsible for making them available to the buyer at the named place of destination cleared for import, but not unloading them from the transport vehicle.*

Notes:

- For international shipments, the above billing options can be used in combination with one another, allowing the shipper, receiver or third party to be billed for all or part of the shipping charges. International shipping charges typically include the cost of transportation, duties, brokerage fees and taxes.
- Unless otherwise specified at the time of shipping, shipping charges are billed to the shipper. In the event of non-payment by the consignee or third party, the charges are billed to the shipper.

Managing Inbound Charges

Control who can and cannot bill shipping charges to your UPS account number. There are two convenient ways to manage this process. Select the option that is appropriate for your business needs.

– Allow any shipper to bill shipping charges to your UPS account number, except for certain shippers you wish to exclude.

– Allow only certain shippers to bill shipping charges to your UPS account and exclude all others.

To begin controlling your inbound charges, go to [ups.com/billing](https://www.ups.com/billing).

Consolidated Payment Plans

A Consolidated Payment Plan offers a convenient way to aggregate UPS invoices for multiple UPS account numbers into a single invoice for payment.

Consolidated Payment Plans can be created for UPS domestic, export and import invoices.

To learn more about Consolidated Payment Plans, call 1-800-PICK-UPS® (1-800-542-5877).

Managing Additional Charges

Additional charges can occur when shipments are not processed properly.

Tips for avoiding these charges may be found at [ups.com/avoidcharges](https://www.ups.com/avoidcharges).

Domestic, Export and Import

Appendix – Value-Added Services

PACKAGE

The following Value-Added Services are available. For more information on other Value-Added Services, see pages [114-126](#).

Available Options	Description	Fee
Signature Required – Commercial Delivery	– UPS will obtain a signature upon delivery at a commercial location. UPS may obtain, at its discretion, an electronic authorization to release the package without a signature on delivery.	\$6.75
UPS Delivery Intercept®	<p>– As the shipper, you have the ability to request that UPS take one of the following actions with your package once you have tendered it to UPS:</p> <ul style="list-style-type: none"> • Return the package to you (additional transportation fees and all applicable surcharges may apply). • Reroute the package to a new address (additional transportation fees and all applicable surcharges may apply). • Have the package available at Will Call* for pickup (no charge for Will Call). • Have the package delivered on a future date. <p>– When the package is tracked, the status of the UPS Delivery Intercept request will be displayed.</p> <p>– Shippers can make a UPS Delivery Intercept request electronically through the Shipping History with WorldShip® or UPS CampusShip® shipping systems, ups.com shipping, Quantum View Manage® or UPS tracking on ups.com.</p> <p>– A UPS Delivery Intercept request can also be made by calling 1-800-PICK-UPS® (1-800-742-5877).</p>	
Return Package to Shipper	– Web/Electronic	\$18.60
Return Package to Shipper	– Phone	\$25.90
Reroute Package to New Address	– Web/Electronic	\$18.60
Reroute Package to New Address	– Phone	\$25.90
Reschedule Delivery to Future Date	– Web/Electronic	\$18.60
Reschedule Delivery to Future Date	– Phone	\$25.90
UPS On-Call Pickup®	<p>– With one pickup request, UPS will pick up all of your packages at a location of your choosing (not limited to home or office). Schedule a same-day or future-day pickup via ups.com or by calling 1-800-PICK-UPS (1-800-742-5877).</p> <p>– Fees are applied per pickup request regardless of the number of packages being picked up.</p> <p>– Residential, area and fuel surcharges may apply.</p> <p>– Scheduled pickup options are not available for UPS Worldwide Express Freight® Midday or UPS Worldwide Express Freight® shipments. UPS On-Call Pickup requests for these two services must be requested using WorldShip, UPS CampusShip, ups.com shipping, UPS Ready® solution, UPS® Developer Kit, ups.com or by calling 1-800-782-7892.</p>	
Shipper Location Future-Day Pickup	– Web/Electronic	\$8.50
Shipper Location Future-Day Pickup	– Phone	\$8.50
Shipper Location Same-Day Pickup	– Web/Electronic	\$13.90
Shipper Location Same-Day Pickup	– Phone	\$13.90
Alternate Location Future-Day Pickup	– Web/Electronic	\$8.50
Alternate Location Future-Day Pickup	– Phone	\$8.50
Alternate Location Same-Day Pickup	– Web/Electronic	\$13.90
Alternate Location Same-Day Pickup	– Phone	\$13.90
Air Package Return Future-Day Pickup	– Web/Electronic	\$8.50
Air Package Return Future-Day Pickup	– Phone	\$8.50
Air Package Return Same-Day Pickup	– Web/Electronic	\$13.90
Air Package Return Same-Day Pickup	– Phone	\$13.90
UPS® Ground & UPS 3 Day Select® Package Return Future-Day Pickup	– Web/Electronic	\$8.50
UPS Ground & UPS 3 Day Select Package Return Future-Day Pickup	– Phone	\$8.50
UPS Ground & UPS 3 Day Select Package Return Same-Day Pickup	– Web/Electronic	\$13.90
UPS Ground & UPS 3 Day Select Package Return Same-Day Pickup	– Phone	\$13.90

*Will Call available only at select UPS Customer Centers.

Domestic, Export and Import

Appendix – Value-Added Services

PACKAGE

Available Options	Description	Fee
UPS Web Return Label	– Print the return label directly from the website of the company where you are purchasing the merchandise. The return label will be created and will display for print. The fee will be charged when the shipment is scanned by UPS for return service.	\$1.05 per online request
Call Tag	– UPS prints a return label, and a UPS driver makes at least one attempt to collect the return package.	\$8.90
UPS My Choice® – Same-Day Will Call*	– Request to hold a package for same-day pickup at Will Call* in a UPS Customer Center.	No charge
UPS My Choice – Future-Day Will Call*	– Request to hold a package for future-day pickup at Will Call* in a UPS Customer Center.	No charge
UPS My Choice® for Business – Same-Day Will Call*	– Request to hold a package for same-day pickup at Will Call* in a UPS Customer Center.	No charge
UPS My Choice for Business – Future-Day Will Call*	– Request to hold a package for future-day pickup at Will Call* in a UPS Customer Center.	No charge

*Will Call available only at select UPS Customer Centers.

Domestic, Export and Import

Appendix – Other Charges

PACKAGE

The following Other Charges may apply. See pages [127-130](#) for additional charges.

Available Options	Description	Fee			
Lookup Surcharge	– A processing fee will be charged for missing/invalid information.	\$21.00			
Unauthorized Service Charge	– In the event of non-payment by the recipient or third party, the original shipper will be billed a refusal fee in addition to the shipping charges.	\$21.00			
Dangerous Goods Category A	– Category A Infectious Substances assigned to UN2814 or UN2900	\$75.50			
Additional Handling – Non-Corrugated	– An Additional Handling charge will be assessed for any non-corrugated package that requires special handling.	Domestic	Zone 2	Zones 3-4	Zones 5+
			\$19.50	\$23.00	\$24.50
Additional Handling – Flat	– An Additional Handling charge will be assessed for any package routed through UPS's irregular package sortation process, including but not limited to packages 1 inch or less in height.	Domestic	Zone 2	Zones 3-4	Zones 5+
			\$19.50	\$23.00	\$24.50

Index

A

- Additional Charges
 - See Value-Added Services and Other Charges [114–138](#)
 - Additional Consignee or Invoice [141](#)
 - Additional Handling [115, 127, 152](#)
 - Address Correction [115, 132](#)
 - Air Freight [134](#)
 - Package [127](#)
 - UPS Worldwide Expedited Ground Freight [137](#)
 - Adult Signature Required [114, 116](#)
 - Advancement of Charges [132, 134, 137](#)
 - Air Freight NGS [21, 77](#)
 - Air Freight Services [76–77](#)
 - Truckload and Intermodal [b, 6](#)
 - Air Shipping Documents (ASDs) [24](#)
 - Alcoholic Beverages [8](#)
 - Alliance Location (Staples) [9, 26](#)
 - Ammunition [8](#)
 - Appendix
 - Other Charges [152](#)
 - Value-Added Services [150–151](#)
 - Authorized Shipping Outlet [9, 26](#)
 - Automated Processing
 - Air Freight [23–24](#)
 - Package [23–24](#)
- ## B
- Batteries [11](#)
 - Billing Options
 - Air Freight [149](#)
 - Duty and Tax Forwarding [114, 122](#)
 - Package [148–149](#)
 - Bill of Lading [16](#)
 - Bonds
 - Continuous Transaction Bond [141](#)
 - In-Transit Bond (IT Bond) [141](#)
 - Single Entry Bond (SEB) [141](#)
 - Branded Tracking from UPS [114, 121](#)
 - Brokerage Services [78, 139–143](#)
 - Bundled or Strapped Boxes [11](#)

C

- Call Tag [151](#)
- Canada
 - Canada Zone Chart
 - Export [35–39](#)
 - Import [44](#)
 - UPS 3 Day Select from Canada [4, 44, 108, 140](#)
 - UPS Standard
 - From Canada [4, 44, 96, 109–110, 140](#)
 - To Canada [4, 35–39, 78, 90–92](#)
 - UPS Worldwide Express Service (to Canada) [4](#)
- Canadian Import Termination Fee [131, 133](#)
- Certificate of Origin [114, 122, 133, 136](#)
 - Air Freight [133](#)
 - UPS Worldwide Expedited Ground Freight [136](#)
- Chargeback for Consignee Billing Shipments [115, 132](#)
 - Air Freight [134](#)
 - Package [127](#)
 - UPS Worldwide Expedited Ground Freight [137](#)
- Check [147, 148, 149](#)
- Claims [146](#)
- Collect on Delivery (C.O.D.) Services [114, 116](#)
 - C.O.D. Service Restrictions [8](#)
- Complex Entries [141](#)
- Constant Surveillance [131, 133](#)
- Coyote Logistics [b, 19, 23, 24, 25, 145, 147](#)
 - Collaborative Transportation Management [5, 6](#)
 - CoyoteGO [145](#)
 - CoyoteHOWL [24](#)
 - Truckload and Intermodal [5, 6, 25](#)
- Credit Extension Fee [148](#)
- Currency Conversion Rate [114, 122](#)
- Customer Service
 - International Customer Service [78, 96](#)
 - UPS Customer Service [b, 146](#)
- Customized Brokerage Services [142](#)
- Customs Brokerage [78, 139–143](#)
- Customs Clearance Entry Preparation Charges [140](#)
- Customs Entry Packets [142](#)

Index

D

Daily On-Route Pickup [25, 114, 118](#)
 Daily Pickup [25, 114, 118](#)
 Dangerous Goods [7, 8, 9, 115, 128, 132](#)
 Air Freight [134](#)
 International [7, 8, 115, 128, 132, 134](#)
 Dangerous Goods Category A [152](#)
 Day-Specific Pickup [25, 114, 118, 150](#)
 Declared Value for Carriage [114, 121, 131](#)
 Air Freight [133](#)
 UPS Worldwide Expedited Ground Freight [136](#)
 Delivery Area Surcharge [115, 128](#)
 Commercial, Commercial Extended [128](#)
 Residential, Residential Extended [128](#)
 Delivery Attempt
 Air Freight [135](#)
 Package [128](#)
 UPS Worldwide Expedited Ground Freight [138](#)
 Delivery Change Request [114, 124](#)
 Delivery or Pickup Service (North American Air Freight) [131, 133](#)
 Delivery Reattempt [115, 128](#)
 Demand Surcharges [115, 128](#)
 Destination Outside Service Area [115, 128](#)
 Detention of Vehicle [132](#)
 UPS Worldwide Expedited Ground Freight [137](#)
 Determine the Rate
 Domestic, Export and Import [28–29](#)
 Determine the Weight and Size [18–22](#)
 Air Freight [21–22](#)
 Domestic Shipments [18–19](#)
 International Shipments [18–19](#)
 Irregularly Shaped Packages [19](#)
 Items Shipped in Bags [19](#)
 Letter Rates [19](#)
 UPS Worldwide Expedited Ground Freight [21](#)
 UPS Worldwide Express Freight [20](#)
 UPS Worldwide Express Freight Midday [20](#)
 Determine the Zone
 Domestic [29](#)
 Export [29](#)
 Import [29](#)
 Dimensional Weight
 Air Freight [21–22](#)
 Package [18–19, 78, 96](#)
 Domestic [18–19](#)
 International [18–19](#)
 UPS Worldwide Expedited Ground Freight [21](#)
 UPS Worldwide Express Freight [20](#)
 UPS Worldwide Express Freight Midday [20](#)
 Direct Delivery Only [114, 117](#)

D (continued)

Disbursement Fee [142](#)
 Documentation
 Air Shipping Documents (ASDs) [24](#)
 Domestic Freight Service Options
 Air Freight [76–77](#)
 Truckload and Intermodal [b, 6, 23, 24, 25](#)
 Domestic Package Rates and Services
 UPS 2nd Day Air [4, 62–65](#)
 UPS 2nd Day Air A.M. [4, 58–61](#)
 UPS 3 Day Select [4, 66–69](#)
 UPS Express Critical [4, 5, 7](#)
 UPS Ground [4, 70–73](#)
 UPS Ground with Freight Pricing [6](#)
 UPS Next Day Air [4, 50–53](#)
 UPS Next Day Air Early [4, 46–49](#)
 UPS Next Day Air Saver [4, 54–57](#)
 UPS Simple Rate [4, 74–75](#)
 Dry Ice [7, 115, 129](#)
 Duty [142](#)
 Duty and Tax Forwarding [114, 122](#)
 Duty Drawbacks [141](#)

E

Electronic Export Information (E.E.I.) [114, 122](#)
 Electronic Funds Transfer [148](#)
 Electronic Label [123](#)
 Electronic Media [11, 19, 28](#)
 Electronic Return Label [114, 120](#)
 Entry-Line Charge [141](#)
 Entry Type 86 Processing [141](#)
 Export Declaration Fee [131, 133](#)
 Export Support [78, 96](#)
 Extended Area Surcharge [115, 129](#)

F

Fabric and Wallpaper [12](#)
 Fee Advance [132, 134](#)
 Firearms [8, 9, 26](#)
 Fish and Wildlife (F&W) Entry Preparation [141](#)
 Flex Global View [145](#)
 Foreign Trade Zone (FTZ) Entry [140, 141, 142](#)
 Formal Entry [143](#)
 Free Domicile [131, 133, 149](#)
 Freight Between the U.S. and Mexico [4, 5, 131, 132, 136, 137, 138](#)
 Freight Preparation [15–17](#)
 Fuel Surcharge [116–130, 133–136](#)
 Full-Container Load (FCL) NVOCC Service [5](#)

Index

G

Ground Shipping Documents [24](#)

H

Hazardous Materials and Dangerous Goods [b, 7, 115, 128](#)

Air Freight [134](#)

Package [128](#)

Hazardous Materials and International Dangerous Goods [7, 8, 115, 128](#)

Hazardous Materials Service Restrictions

Setting Up Service [7](#)

To and From Alaska, Hawaii, Puerto Rico and Other Locations [7](#)

Hearing Impaired Service Number 1-800-833-0056

Heavy Package [12](#)

Heavy Package Sticker [12](#)

Hold at Destination Airport for Pickup (HAPU)

Air Freight [133](#)

UPS Worldwide Expedited Ground Freight [136](#)

Hold at Location [114, 117](#)

Hold for Pickup [26, 114, 117](#)

Import Control [26](#)

Import Service Fee [131, 133, 136](#)

Import Support [78, 96](#)

InsureShield Shipping Insurance [6](#)

Intermodal [6, 23, 24, 25, 29](#)

International Customer Service Center 1-800-782-7892

International Dangerous Goods (IDG) [7, 115, 128](#)

International Freight Services [4, 5](#)

International Rates and Services

UPS 3 Day Select from Canada [4, 96, 108](#)

UPS Air Freight Consolidated [4, 21](#)

UPS Air Freight Direct [4, 21](#)

UPS Air Freight Premium Direct [4, 21](#)

UPS Express Critical [4, 5](#)

UPS Standard from Canada [4, 96, 109–110, 140](#)

UPS Standard from Mexico [4, 111–113](#)

UPS Standard to Canada [4, 35–39, 78, 90–92](#)

UPS Standard to Mexico [4, 78, 93–95](#)

UPS Worldwide Expedited [4, 5, 78, 87–89, 105–107](#)

UPS Worldwide Express [4, 78, 79–81, 96, 97–99](#)

UPS Worldwide Express Freight [4, 83, 101](#)

UPS Worldwide Express Freight Midday [4, 82, 100](#)

UPS Worldwide Express NA1 [4, 96, 97–99](#)

UPS Worldwide Express Plus [4, 78, 79–81, 96, 97–99](#)

UPS Worldwide Saver [4, 84–86, 96, 102–104](#)

I (continued)

International Service Options [4, 5](#)

Invoice

Air Freight [149](#)

Invoice Removal [123](#)

Package [141, 148–149](#)

UPS Worldwide Expedited Ground Freight [149](#)

Irregularly Shaped Items and Bare Metals [12](#)

J

Jewelry [8](#)

L

Label

1 UPS Pickup Attempt Label [114, 120, 123](#)

3 UPS Pickup Attempts Label [114, 120, 123](#)

Electronic Label [123](#)

Electronic Return Label [114, 120](#)

Print Label [123](#)

Print Return Label [114, 120](#)

UPS Smart Label [24](#)

Large and/or Heavy Packages [12](#)

Large Package Surcharge [19, 115, 129](#)

Late Payment Fee [148](#)

Less-Than-Container Load (LCL) NVOCC Service [5](#)

Liftgate Services [132](#)

Air Freight [134](#)

UPS Worldwide Expedited Ground Freight [137](#)

Limited Quantities (Ltd Qty) [7, 26, 28, 128](#)

Lookup Surcharge [152](#)

Index

M

- Manual Processing – Package [24](#)
- Marking Notice Processing [143](#)
- Maximum Declared Values [8](#)
- Maximum Length [8](#)
- Maximum Size [8](#)
- Maximum Weight [8](#)
- Merchandise Processing Fee [143](#)
- Mexico
 - UPS Standard
 - From Mexico [4, 111–113, 140](#)
 - To Mexico [4, 93–95](#)
 - Zone Chart [40, 45](#)
- Missing/Invalid Account Number or Refusal Fee [115, 132](#)
 - Air Freight [134](#)
 - Package [129](#)
 - UPS Worldwide Expedited Ground Freight [137](#)
- Missing PLD Fee [129](#)

N

- Navigation Canada Fee [131, 133](#)
- Non-Conforming Freight [132](#)
 - Air Freight [134](#)
 - UPS Worldwide Expedited Ground Freight [137](#)
- Non-Resident Importer (NRI) [114, 122](#)
- North American Air Freight [5, 131–134](#)
- North American Freight [5–6, 76–77, 131–134](#)
- NYC Surcharge [132, 134](#)

O

- 1 UPS Pickup Attempt Label [114, 120, 123](#)
- Ocean Freight [5](#)
- Ocean Freight Forwarding [5](#)
- Origin or Destination Special Handling Fee [131, 133](#)
- Other Charges
 - Air Freight [132, 134, 135](#)
 - Ground Freight [132, 137–138](#)
 - Package [115, 127–130](#)
- Over Maximum Limits [115, 129](#)
- Oversize [132](#)
 - Air Freight [135](#)
- Oversize Pallet Handling Surcharge [115, 129](#)
- Overtime/Special Handling Service [143](#)

P

- Package
 - International (Export Except Canada) Zone Chart [31–34](#)
 - Package Tracking, Tracing and Refund Requests [115, 129](#)
- Packaging Assistance
 - Packaging Advisor [13](#)
 - Packing Services [13](#)
 - UPS Package Design and Test Lab [13](#)
- Packaging Guidelines [14–17](#)
 - Air Freight [15–17](#)
 - UPS Worldwide Expedited Ground Freight [15–17](#)
 - UPS Worldwide Express Freight [15–17](#)
 - UPS Worldwide Express Freight Midday [15, 16, 20](#)
- Packaging Needs
 - Heavy Package [12](#)
 - Packages Weighing More Than 70 Pounds [12](#)
 - Special Packaging Needs [11–13](#)
- Pack & Ship Guarantee [13](#)
- Palletized Freight [15–17](#)
 - Non-Palletized Freight [15, 17](#)
- Palletized Shipments [15, 82, 100](#)
 - International Palletized Shipments [20](#)
- Paper Commercial Invoice Services Surcharge [115, 130](#)
- Parcel Pro Select [b, 6](#)
- Partner Government Agency (PGA) Clearance [142](#)
- Payer Rebilling Fee [132](#)
 - Air Freight [135](#)
 - UPS Worldwide Expedited Ground Freight [138](#)
- Payment Options [147–149](#)
- Payments (Merchant Services) [6](#)
- Pickup and Drop-off Availability [25–26](#)
- Pickup Area Surcharge [115, 130](#)
- Post Entry Services [143](#)
- Premium City Fee – Origin/Destination [132, 135](#)
- Prepare Your Shipment
 - See Packing Guidelines [15–17](#)
- Pre-Release Notification [143](#)
- Print Label [123](#)
- Print Return Label [114, 120](#)
- Prior Notice for Food and Food Products [142](#)
- Prohibited and Restricted Goods
 - Export and Import [8–9](#)
 - Package [8–9](#)
- Prohibited Item Fee [115, 130](#)
- Project Cargo Management [5](#)
- PRO Number [16](#)
- Proof of Delivery (P.O.D.) [114, 121, 131](#)
 - Air Freight [133](#)
 - Package [146](#)
 - UPS Worldwide Expedited Ground Freight [136](#)

Index

Q

- Quantum View Data [145](#)
- Quantum View Manage [145](#)
- Quantum View Notify [145](#)

R

- Rates
 - Air Freight [29,76–77](#)
 - Package
 - Domestic [29,46–73](#)
 - Export [29,79–95](#)
 - Import [29,97–113](#)
- Rebill Fee [115,130](#)
- Redelivery [132](#)
 - Air Freight [135](#)
 - UPS Worldwide Expedited Ground Freight [138](#)
- Reference Number [146](#)
- Remote Area Surcharge [115,130](#)
- Residential Delivery/Pickup [132](#)
 - Air Freight [135](#)
- Residential Surcharge [115,130](#)
- Reviewing Your Invoice [147–149](#)

S

- Saturday Air Processing Fee (Saturday Pickup) [114,119](#)
- Saturday Delivery [114,119,131](#)
 - Air Freight [119,133](#)
- Saturday Export Processing Fee [114,119](#)
- Saturday Pickup [131](#)
 - Air Freight [133](#)
 - Package [119](#)
- Saturday Stop Charge [114,119](#)
 - Scheduled Pickup [114,119](#)
 - UPS On-Call Pickup [114,119](#)
 - UPS Smart Pickup [114,119](#)

S (continued)

- Scheduled Pickup Options [25](#)
 - Daily On-Route Pickup [25,114,118](#)
 - Daily Pickup [25,114,118](#)
 - Day-Specific Pickup [25,114,118,119,150](#)
 - Package [25](#)
 - UPS Smart Pickup [25,114,118,150](#)
- Security Surcharge [132,135,138](#)
- Service Options
 - Air Freight [4,5](#)
 - Package
 - Domestic [4](#)
 - International [4,5](#)
 - Truckload and Intermodal [5,6](#)
- Service Restrictions [7–9](#)
 - Air Freight [7–9](#)
 - Package [7–9](#)
 - Prohibited and Restricted Goods [8–9](#)
- Shipment Pricing
 - Export [78](#)
 - Import [96](#)
- Shipper's Export Declaration (S.E.D.)
 - See Electronic Export Information (E.E.I.) [114,122](#)
- Shipping Charge Correction Audit Fee [115,130](#)
- Shipping Forms [78,96](#)
- Shipping Solutions [23–24](#)
- Ship to a UPS Access Point Location [114,117](#)
- Signature Required [114,116](#)
- Signature Tracking [146](#)
- Special Delivery or Pickup Surcharge [131,133](#)
- Special Handling of Undeliverable Shipments [115,130](#)
- Special Packaging Needs (Package) [11–13](#)
- Staples [9,26](#)
- State Classifications and Abbreviations
 - West and East [30](#)

Index

T

- 3 UPS Pickup Attempts Label [114, 120, 123](#)
- Table of Contents [2](#)
- Telecommunications Device for the Deaf Service Number 1-800-833-0056 [b](#)
- Temporary Import Under Bond [142](#)
- Thermal Label Printer [24](#)
- The UPS Store [b, 9, 13, 26](#)
- Third Party Billing Service [114, 121](#)
- Third-Party Retail Locations
 - Alliance Location (Staples) as well as Authorized Shipping Outlets [9, 26](#)
- Tires [12](#)
- Tobacco [9](#)
- Track Your Shipment [145–146](#)
 - Coyote [145](#)
 - Flex Global View [145](#)
 - Quantum View Data [145](#)
 - Quantum View Manage [145](#)
 - Quantum View Notify [145](#)
 - Reference Number [146](#)
 - Text Message [146](#)
 - Tracking Number [146](#)
 - UPS InfoNotice Number [145](#)
 - UPS Mobile App [145](#)
 - UPS My Choice [145, 151](#)
 - UPS My Choice for Business [145, 151](#)
 - Within Your Business [146](#)
- Transportation Handling [143](#)
- Truck Waiting Time [132](#)
 - Air Freight [135](#)
 - UPS Worldwide Expedited Ground Freight [138](#)

U

- Unauthorized Service Charge [152](#)
- Undeliverable Shipment Surcharge [115, 130](#)
- United States-Mexico-Canada Agreement (USMCA) Processing [143](#)
- UPS 2nd Day Air [4, 62–65, 114, 115](#)
 - Letter Rate [62](#)
- UPS 2nd Day Air A.M. [4, 58–61, 114, 115](#)
 - Letter Rate [58](#)
- UPS 2nd Day Air Freight [5, 21, 76, 131, 132](#)
- UPS 2nd Day Air Freight NGS [5, 21, 77, 131, 132](#)
- UPS 3 Day Freight [5, 21, 76, 131, 132](#)
- UPS 3 Day Freight NGS [5, 21, 77, 131, 132](#)
- UPS 3 Day Select [4, 7, 24, 66–69, 114, 115](#)
- UPS 3 Day Select from Canada [4, 44, 108, 114, 115, 140](#)
- UPS Access Point [26, 114, 117](#)

U (continued)

- UPS Air Freight Consolidated [4, 21](#)
- UPS Air Freight Direct [4, 21](#)
- UPS Air Freight Premium Direct [4, 21](#)
- UPS Alliance Location (Staples) [9, 26](#)
- UPS Authorized Service Provider [26](#)
- UPS Authorized Shipping Outlet [9, 26](#)
- UPS Automatic Alerts for Non-UPS My Choice Members [114, 126](#)
- UPS Billing and Payment Schedules
 - Billed Monthly/Pay Monthly [148](#)
 - Billed Weekly/Pay Monthly [148](#)
 - Billed Weekly/Pay Weekly [148](#)
- UPS Billing Center [147, 148](#)
- UPS Billing Data [147](#)
- UPS Billing/Payer Options
 - Bill Receiver (Freight Collect) [149](#)
 - Bill Shipper (Prepaid) [149](#)
 - Bill Third Party [149](#)
 - Free Domicile [149](#)
 - Shipper's Check Received [149](#)
 - Split Duty and Tax [149](#)
- UPS Broker of Choice [139, 142](#)
- UPS CampusShip [b, 23](#)
- UPS carbon neutral [114, 121](#)
- ups.com [b, 146](#)
- ups.com shipping [23](#)
- UPS Customer Center [26](#)
- UPS Delivery Intercept [114, 117, 150](#)
- UPS Developer Kit [24](#)
- UPS Drop Box [26](#)
- UPS Express Critical [4, 5](#)
- UPS Express Pak [19](#)
- UPS Forwarding Hub [23](#)
- UPS FTZ Facilitator [140, 142](#)
- UPS Ground [4, 24, 70–73, 114, 115](#)
- UPS Ground Shipping Documents [24](#)
- UPS Ground with Freight Pricing [6](#)
- UPS Hundredweight Service [6](#)
- UPS Import Control [26, 96, 114, 123](#)
- UPS InfoNotice Number [145](#)
- UPS Marketplace Shipping Solutions [23](#)
- UPS Mobile App [24, 145](#)
- UPS My Choice [114, 125, 145, 151](#)
 - UPS My Choice Premium [125](#)
- UPS My Choice for Business [114, 126, 151](#)
- UPS Next Day Air [4, 50–53, 114, 115](#)
 - Letter Rate [50](#)

Index

U (continued)

UPS Next Day Air Early [4, 46–49, 114, 115](#)
 Letter Rate [46](#)

UPS Next Day Air Freight [5, 21, 76, 131, 132](#)

UPS Next Day Air Freight NGS [5, 21, 77, 131, 132](#)

UPS Next Day Air Saver [4, 54–57, 114, 115](#)
 Letter Rate [4, 54](#)

UPS On-Call Pickup [25, 114, 118, 119, 150](#)
 UPS On-Call Pickup Area Surcharge [115, 129](#)

UPS On-Call Pickup Saturday Stop Charge [114](#)

UPS Package Design and Test Lab [13](#)

UPS Paper Bill [147](#)

UPS Paperless Invoice [78, 96](#)

UPS PDF Invoice [147](#)

UPS Preferred Multimodal Freight Services [5](#)

UPS Premier [114, 121](#)

UPS Ready [23, 24](#)

UPS Returns [120–121, 151](#)
 UPS Returns Services [9, 120](#)

UPS Service Guarantee [130, 139, 140](#)

UPS Services
 Air Freight [4, 5](#)
 Domestic [4, 5](#)
 International [4, 5](#)
 Truckload and Intermodal [5, 6](#)

UPS Services Website Address
[ups.com/services](#) [b](#)

UPS Simple Rate [74–75](#)

UPS Smart Label [24](#)

UPS Smart Pickup [25, 114, 118, 119](#)

UPS Smart Pickup Saturday Stop Charge [114, 119](#)

UPS Standard
 From Canada [4, 44, 96, 109–110, 114, 115, 140](#)
 From Mexico [4, 45, 111–113, 114, 115, 140](#)
 To Canada [4, 35–39, 78, 90–92, 114, 115](#)
 To Mexico [4, 40, 78, 93–95, 114, 115](#)

UPS Standard Zone Chart
 From Canada [44](#)
 From Mexico [45](#)
 To Canada [35–39](#)
 To Mexico [40](#)

UPS Supply Chain Solutions
 Call Centers [25](#)

UPS Supply Chain Solutions Quick Zip [76, 77](#)

UPS SurePost [125](#)

UPS SurePost Weekend Residential Delivery [119](#)

U (continued)

UPS TradeAbility Services [78, 96](#)

UPS Website Address [ups.com](#)

UPS Worldwide Expedited [114, 115](#)
 Export [4, 31–39, 78, 87–89](#)
 Import [4, 41–43, 105–107, 140](#)

UPS Worldwide Expedited Air Freight [5, 21](#)

UPS Worldwide Expedited Ground Freight [5, 21, 131, 132, 136, 137, 138](#)

UPS Worldwide Expedited Truckload [5](#)

UPS Worldwide Express [114, 115](#)
 Export [4, 31–39, 78, 79–81](#)
 10 KG Box [79](#)
 25 KG Box [79](#)
 Letter Rate [79](#)
 Pak Rate [79](#)
 Import [4, 41–43, 96, 97–99, 140](#)
 Letter Rate [97](#)

UPS Worldwide Express Freight [114, 115](#)
 Export [4, 31–39, 83](#)
 Import [4, 41–43, 96, 101, 140](#)

UPS Worldwide Express Freight Center [26](#)

UPS Worldwide Express Freight Midday [114, 115](#)
 Export [4, 31–39, 82](#)
 Import [4, 41–43, 100, 140](#)

UPS Worldwide Express NA1 [114, 115](#)
 Import [4, 41, 42, 43, 96, 97–99, 140](#)
 Letter Rate [97](#)

UPS Worldwide Express Plus [114, 115](#)
 Export [4, 31–39, 78, 79–81](#)
 10 KG Box [79](#)
 25 KG Box [79](#)
 Letter Rate [79](#)
 Pak Rate [79](#)
 Import [4, 41–43, 96, 97–99, 140](#)
 Letter Rate [97](#)

UPS Worldwide Saver [114, 115](#)
 Export [4, 31–39, 84–86](#)
 10 KG Box [84](#)
 25 KG Box [84](#)
 Letter Rate [84](#)
 Pak Rate [84](#)
 Import [4, 41–43, 96, 102–104, 140](#)
 Letter Rate [102](#)

UPS Worldwide Services Waybill [24](#)

U.S. Export Compliance Fee [131, 133, 136](#)

Index

V

Value-Added Services

Air Freight [131, 133](#)

Ground Freight [131, 136](#)

Package [114, 116–126](#)

Vaping Products [9](#)

W

Warehouse

Entry [142](#)

Storage [143](#)

Waybill [24](#)

Weapons [8](#)

Weight and Size

Air Freight [21](#)

Package [18–19](#)

UPS Worldwide Expedited Ground Freight [21](#)

UPS Worldwide Express Freight [20](#)

UPS Worldwide Express Freight Midday [20](#)

West and East State Classifications [30](#)

Will Call [117, 124–126, 150–151](#)

World Ease [114, 123](#)

WorldShip [23](#)

Z

Zone Charts

Air Freight [29, 31–45](#)

Package

All (Except Canada) [31–34](#)

Determine the Zone [29, 31–45](#)

International Export

To Canada [35–39](#)

To Mexico [40](#)

International Import

UPS 3 Day Select and UPS Standard from Canada [44](#)

UPS Standard from Mexico [45](#)



[ups.com](https://www.ups.com)

© 2023 United Parcel Service of America, Inc. UPS, the UPS brandmark and the color brown are trademarks of United Parcel Service of America, Inc. All rights reserved. 12/23